



ALM
7785

Census of India, 1931

VOLUME XX

312 19

CENTRAL INDIA AGENCY

PART I.—REPORT

By

C. S. VENKATACHAR,
OF THE INDIAN CIVIL SERVICE,
SUPERINTENDENT OF CENSUS OPERATIONS.

312.0954

C.I. (31)

D 9465 (a)
150/33

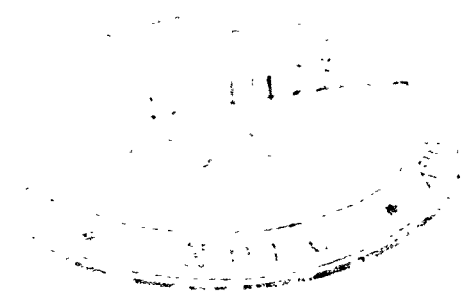

CALCUTTA: GOVERNMENT OF INDIA
CENTRAL PUBLICATION BRANCH
1933

Government of India Publications are obtainable from the Government of India Central Publication Branch, 3, Government Place, West, Calcutta, and from the following Agents :—

EUROPE.

OFFICE OF THE HIGH COMMISSIONER FOR INDIA, India House, Aldwych, LONDON, W. C. 2.

And at all Booksellers.

INDIA AND CEYLON :

Provincial Book Depôts.

MADRAS :—Superintendent, Government Press, Mount Road, Madras.
BOMBAY :—Superintendent, Government Printing and Stationery, Queen's Road, Bombay.
SIND :—Library attached to the Office of the Commissioner in Sind, Karachi.
BENGAL :—Bengal Secretariat Book Depôt, Writers' Buildings, Room No. 1, Ground Floor, Calcutta.
UNITED PROVINCES OF AGRA AND OUDH :—Superintendent of Government Press, United Provinces of Agra and Oudh, Allahabad.
PUNJAB :—Superintendent, Government Printing, Punjab, Lahore.
BURMA :—Superintendent, Government Printing, Burma, Rangoon.
CENTRAL PROVINCES AND BERAR :—Superintendent, Government Printing, Central Provinces, Nagpur.
ASSAM :—Superintendent, Assam Secretariat Press, Shillong.
BIHAR AND ORISSA :—Superintendent, Government Printing, Bihar and Orissa, P. O. Gulzarbagh, Patna.
NORTH-WEST FRONTIER PROVINCE :—Manager, Government Printing and Stationery, Peshawar.

Thacker, Spink & Co., Ltd., Calcutta and Simla.
 W. Newman & Co., Ltd., Calcutta.
 S. K. Lahiri & Co., Calcutta.
 The Indian School Supply Depôt, 309, Bow Bazar Street, Calcutta.
 Butterworth & Co. (India), Ltd., Calcutta.
 M. C. Sarcar & Sons, 15, College Square, Calcutta.
 Standard Literature Company, Limited, Calcutta.
 Association Press, Calcutta.
 Chukerverty, Chatterjee & Co., Ltd., 13, College Square, Calcutta.
 The Book Company, Calcutta.
 James Murray & Co., 12, Government Place, Calcutta.
 (For Meteorological Publications only.)
 Ray Chaudhury & Co., 68-5, Ashutosh Mukherji Road, Calcutta.
 Scientific Publishing Co., 9, Taitola Lane, Calcutta.
 Chatterjee & Co., 3-1, Bacharam Chatterjee Lane, Calcutta.
 Standard Law Book Society, 5, Hastings Street, Calcutta.
 The Hindu Library, 3, Nandalal Mullick Lane, Calcutta.
 Kamala Book Depôt, Ltd., 15, College Square, Calcutta.
 The Pioneer Book Supply Co., 20, Shib Narain Das Lane, Calcutta.
 P. C. Sarkar & Co., 2, Shama Charan De Street, Calcutta.
 *Bengal Flying Club, Dum Dum Cantt.
 Kali Charan & Co., Municipal Market, Calcutta.
 N. M. Roy Chowdhury & Co., 11, College Sqr., Calcutta.
 Grantha Mandir, Cuttack.
 B. C. Basak, Esq., Proprietor, Albert Library, Dacca.
 Higginbothams, Madras.
 Rochouse and Sons, Madras.
 G. A. Nateson & Co., Publishers, George Town, Madras.
 P. Varadachary & Co., Madras.
 City Book Co., Madras.
 Law Publishing Co., Mylapore, Madras.
 The Booklover's Resort, Taikad, Trivandrum, South India.
 E. M. Gopalakrishna Kône, Pudumandapam, Madura.
 Central Book Depôt, Madura.
 Vijapur & Co., Vizagapatam.
 Thacker & Co., Ltd., Bombay.
 D. B. Taraporevala, Sons & Co., Bombay.
 Ram Chandra Govind & Sons, Kalvadevi Road, Bombay.
 N. M. Tripathi & Co., Booksellers, Princess Street, Kalbadevi Road, Bombay.
 New and Secondhand Bookshop, Kalbadevi Road, Bombay.
 J. M. Pandia & Co., Bombay.
 A. H. Wheeler & Co., Allahabad, Calcutta and Bombay.
 Bombay Book Depôt, Gurgaon, Bombay.
 Bennett, Coleman & Co., Ltd., The Times of India Press, Bombay.
 The Popular Book Depôt, Bombay.
 Lawrence and Mayo, Ltd., Bombay.
 The Manager, Oriental Book Supplying Agency, 15, Shukrawar, Poona City.
 Rama Krishna Bros., Opposite Bishrambag, Poona City.
 S. P. Bookstall, 21, Budhwar, Poona.
 The International Book Service, Poona 4.
 Mangaldas & Sons, Booksellers and Publishers, Bhaga Talao, Surat.
 The Standard Book and Stationery Co., 32-33. Arbab Road, Peshawar.

The Students Own Book Depôt, Dharwar.
 Shri Shankar Karnataka Pustaka Bhandara, Malamuddi, Dharwar.
 The English Book Depot, Ferozepur.
 Frontier Book & Stationery Co., Rawalpindi.
 *Hossenbhoy Karimji and Sons, Karachi.
 The English Bookstall, Karachi.
 Rose & Co., Karachi.
 Keale & Co., Karachi.
 Ram Chandra & Sons, Ambala, Kasauli.
 The Standard Bookstall, Quetta and Lahore.
 U. P. Malhotra & Co., Quetta.
 J. Ray & Sons, 43, K. & L., Edwardes Road, Rawalpindi, Murree and Lahore.
 The Standard Book Depôt, Lahore, Nainital, Mussoorie, Dalhousie, Ambala Cantonment and Delhi.
 The North India Christian Tract and Book Society, 18, Clive Road, Allahabad.
 Ram Narain Lal, Katra, Allahabad.
 "The Leader," Allahabad.
 The Indian Army Book Depôt, Dayalbagh, Agra.
 The English Book Depôt, Taj Road, Agra.
 Gaya Prasad & Sons, Agra.
 Narain & Co., Meston Road, Cawnpore.
 The Indian Army Book Depôt, Jullundur City, Daryaganj, Delhi.
 Manager, Newal Kishore Press, Lucknow.
 The Upper India Publishing House, Ltd., Literature Palace, Ammuddaula Park, Lucknow.
 Rai Sahib M. Gulab Singh & Sons, Mufid-i-Am Press, Lahore and Allahabad.
 Rama Krishna & Sons, Booksellers, Anarkali, Lahore.
 Students Popular Depôt, Anarkali, Lahore.
 The Proprietor, Punjab Sanskrit Book Depôt, Saidmitha Street, Lahore.
 The Insurance Publicity Co., Ltd., Lahore.
 The Punjab Religious Book Society, Lahore.
 The Commercial Book Co., Lahore.
 The University Book Agency, Kachari Road, Lahore.
 Manager of the Imperial Book Depôt, 63, Chandni Chowk Street, Delhi.
 J. M. Jaina & Bros., Delhi.
 Feno Book Agency, New Delhi and Simla.
 Oxford Book and Stationery Company, Delhi, Lahore, Simla, Meerut and Calcutta.
 Mohanlal Dossabhai Shah, Rajkot.
 Supdt., American Baptist Mission Press, Rangoon.
 Burma Book Club, Ltd., Rangoon.
 S. C. Talukdar, Proprietor, Students & Co., Cooh Behar.
 The Manager, The Indian Book Shop, Benares City.
 Nandkishore & Bros, Chowk, Benares City.
 The Srivilliputtur Co-operative Trading Union, Ltd., Srivilliputtur (S. I. R.).
 Raghunath Prasad & Sons, Patna City.
 The Students' Emporium, Patna
 K. L. Mathur & Bros., Guzri, Patna City.
 Kamala Book Stores, Bankipore, Patna.
 G. Banerjee and Bros., Ranchi.
 M. C. Kothari, Raipura Road, Baroda.
 B. Parikh & Co., Baroda.
 The Hyderabad Book Depôt, Chaderghat, Hyderabad (Deccan).
 S. Krishnaswamy & Co., Teppakulam P. O., Trichinopoly Fort.
 Standard Book and Map Agency, Book Sellers and Publishers, Ballygunge.
 Karnataka Publishing House, Bangalore City.
 Bheema Sons, Fort, Bangalore City.
 Superintendent, Bangalore Press, Lake View, Mysore Road, Bangalore City.

AGENT IN PALESTINE :—Steimatzy, Jerusalem.

*Agents for publications on aviation only.

CENTRAL ARCHAEOLOGICAL LIBRARY, NEW DELHI.
 Acq. No. 31129
 Date 24.4.57
 Call No. 212.0954
 C-I. (315)

TABLE OF CONTENTS.

	PAGE.
CHAPTER I.—Distribution and Movement of the Population.	
Central India—Two main divisions: Central India West and East—Physical features—The role of the Vindhyas—Cultural complexity—Linguistic diversities—Malwa more exposed to cultural impacts—Three broad areas: Bundelkhand, Baghelkhand and Malwa—External changes—Internal changes—Administrative divisions—Their arrangement in the Report and the Tables—Their characteristics—Administrative divisions and demography—Natural divisions—Village institution and land tenure—Communications—Industrial and economic—Scope of the Report—Definition of population—Area, population and density—Variation in population in previous Censuses—Variation in population since 1921—Economic condition of the decade—Variation by principal States—Houses and families	1
SUBSIDIARY TABLES	31
CHAPTER II.—Population of Cities, Towns and Villages.	
Definition of town—Selection of Towns—New Towns—Of Towns in general—The urban population—Distribution of the population between urban and rural areas—Progressive and decaying towns—Sex and Religion in towns—Village—Distribution of rural population—The City of Indore	38
SUBSIDIARY TABLES	50
APPENDIX.—The Indore Residency Area	53
CHAPTER III.—Birth-place and Migration.	
Introductory—Types of Migration—Main figures—Extra-provincial migration—Religion of the migrants—Balance of movements—Inter-provincial Immigration	55
SUBSIDIARY TABLES	64
CHAPTER IV.—Age.	
The basis of the figures—Inaccuracies of the Age returns—Distribution of the population by sex and age periods—Mean age—Age distribution by Religion and Caste—Natural fecundity by Religion and Caste—Longevity	68
SUBSIDIARY TABLES	76
CHAPTER V.—Sex.	
Introductory—Sex proportion in actual population—Variation in sex-ratio—Accuracy of Sex returns—Sex proportion in natural population—Sex proportion by Religion—Sex proportion by age—Sex proportion by Caste—Reasons for the proportions	84
SUBSIDIARY TABLES	91
APPENDIX.—Size and Sex constitution of families	94
CHAPTER VI.—Civil Condition.	
The basis of the figures—Introductory—Main statistics—Civil condition in different religions—Early marriage—Early marriage and caste—General remarks—The widowed	98
SUBSIDIARY TABLES	106
APPENDIX.—A note on the custom known as <i>Ghar-jumai</i>	113
CHAPTER VII.—Infirmities.	
Introductory—Variation—Comparison with contiguous provinces—Multiple infirmities—Insanity by Sex and Age—Deaf-mutism—Main figures—By Sex and Age—Blindness—Main figures—By Sex and Age—Leprosy—Main figures—By Sex and Age	114
SUBSIDIARY TABLES	122

	PAGE.
CHAPTER VIII.—Occupation.	
The basis of the figures—Changes in the occupation returns—Earners and working dependents—Classification scheme—Form of presentation of statistics—Difficulties in classification—Accuracy of the record—General distribution—Working and non-working population—Production of raw materials—Preparation and supply of material substances—Public administration and liberal Arts—Miscellaneous—Occupations of the females—Subsidiary occupations of earners	124
SUBSIDIARY TABLES	141
CHAPTER IX.—Literacy.	
The basis of the figures—Accuracy of the figures—Outlook and attitude towards education—Extent of literacy—Variation of literacy according to locality—Literacy by Religion and Age—Literacy by Caste—Female literacy—Urban and rural literacy—Literacy in English—Progress of literacy by religion and age—Remarks on educational tendencies	151
SUBSIDIARY TABLES	164
CHAPTER X.—Language.	
The basis of the figures—New features of the language returns—Accuracy of the returns—Main features of the returns—General language distribution—Geographical distribution—Linguistic border zones—Bilingualism : General results—Area of Bilingualism—Other features of Bilingualism—Displacement of minor languages	170
SUBSIDIARY TABLES	178
APPENDIX A.—Languages represented on the Linguistic map of Central India Agency	184
APPENDIX B.—Specimens of Bargundi dialect with their Tamil equivalents	186
APPENDIX C.—Rajasthani-Bhili Linguistic Border Zone	189
CHAPTER XI.—Religion.	
The basis of the figures—The meaning of figures—Religion as a basis of statistical classification—General distribution—Variation—Local distribution—Hindu—Tribal—Tribal returns influenced by three factors—Composition of the tribal group—M u s l i m—Christian—Europeans—Anglo-Indians—Jain—Arya—Others—General remarks : Present and future tendencies	190
SUBSIDIARY TABLES	207
APPENDIX A.—Statistics relating to the Social map of Central India Agency	210
CHAPTER XII.—Race, Tribe and Caste.	
The basis of the figures—Scope of the caste returns and their tabulation—Caste classification—Accuracy of the returns—Caste returns : Their utility—Main figures—Depressed castes—Forest and Hill tribes—Modern tendencies	211
SUBSIDIARY TABLES	221
APPENDIX.—Caste glossary	227
Appendices.	
APPENDIX I.—An ethnographic account of the Bhils of Central India	238
APPENDIX II.—Migration of Castes and Tribes into Central India and their distribution	267
APPENDIX III.—The depressed classes	280

LIST OF MAPS AND DIAGRAMS.

	PAGE.
Linguistic map of Central India Agency	Frontispiece.
Social map of Central India Agency	,,
CHAPTER I.	
Map of Central India showing main lines of railway and road communications	13
Diagram showing the relation of area and population	18
Diagram showing the actual population of the principal States of the Agency in 1931	<i>facing</i> 18
Diagram showing the actual population of the principal States of the Agency in 1931 arranged in order of magnitude	<i>facing</i> 18
Map of Central India showing density of the population by States, 1931	19
Diagram showing the growth of the population of the Central India Agency	22
Proportionate changes in the population of some of the principal States in Central India Agency 1881-1931 as shown by the curves of the logs of the population	<i>facing</i> 22
Map of Central India showing variation in population between 1921 and 1931	} <i>facing</i> 23
Map of Central India showing variation in density of the population between 1921 and 1931	
Diagram showing the increase or decrease in the population of principal States of the Agency during the inter-censal period 1921-1931	23
CHAPTER II.	
Diagrams showing the percentage distribution of the urban population among towns of various sizes and variation per cent. in urban and rural population	41
Proportional changes in the population of the cities in Central India 1881-1931 as shown by the curves of the logs of the population	<i>facing</i> 44
Map of Indore City showing density per acre by wards	46
CHAPTER III.	
Diagram showing the percentage of immigrants in each natural division	57
Map of India showing the main migration currents to and from Central India	58
Map of Central India showing the population of immigrants by States	62
CHAPTER IV.	
Age distribution of every 1,000 of each sex in Central India	<i>facing</i> 71
Cumulative curves of Age distribution	<i>facing</i> 71
Diagram showing the distribution by quinquennial age-periods of 10,000 of each sex in Central India	71
CHAPTER V.	
The proportion of sexes in the actual population in 1931	84
Diagram showing the number of females per 1,000 males by main age-periods and by the natural divisions in Central India, 1931	<i>facing</i> 86
CHAPTER VI.	
Diagram showing the proportion per mille who are unmarried, married and widowed	99
Distribution of 1,000 of each sex in each main religion by Civil condition	<i>facing</i> 101
Distribution of 1,000 of each sex in each main religion by four age-periods	<i>facing</i> 101
The number of females per 1,000 aged 0-10 who are married	102

	PAGE.
CHAPTER VII.	
Map of Central India Agency showing the distribution of Insane	116
Diagram showing the number per 100,000 of each sex in each decennial age-period—Insane and deaf-mute <i>facing</i>	117
Map of Central India Agency showing the distribution of Deaf-mute	118
Map of Central India Agency showing the distribution of Blind	119
Diagram showing the number per 100,000 of each sex in each decennial age-period—Blind and leper <i>facing</i>	120
Map of Central India Agency showing the distribution of Leper	121
CHAPTER VIII.	
Diagram showing the distribution of the working population, 1931, by Occupation <i>facing</i>	129
Diagram showing the proportion of the agricultural, industrial, commercial and professional population in Central India <i>facing</i>	130
Map showing the proportion of female to male workers by States	139
CHAPTER IX.	
Diagram showing the number of persons per mille in each natural division who are literate	154
Map showing the number of literates in every 1,000 of the male population of each principal State	156
Diagram showing the number of literates per mille in each main religion	157
Diagram showing literacy among males in selected Castes (2 plates) <i>facing</i>	158
Map showing the literate in English per 10,000 males by States	161
CHAPTER X.	
Linguistic distribution (coloured) <i>facing</i>	173
CHAPTER XI.	
Relative increase or decrease of the different main religions as shown by the curves of the logs of the population <i>facing</i>	193
Map showing the distribution of Hindus by States	194
Diagram showing the religious composition per 1,000 of the population in Central India, 1911-1931	195
Map showing the distribution of Tribals by States	197
Map showing the distribution of Muslims by States	201
CHAPTER XII.	
Diagram showing the proportionate distribution of the main castes and classes in Central India <i>facing</i>	213
Map showing the proportion of the Depressed classes to the total population of each principal State	215
Map showing the proportion of the Primitive tribes to the total population of each principal State	216
APPENDIX II.	
Suggested early racial drifts and migrations	271
Map showing the migration of some of the principal castes into Central India	278

INTRODUCTION.

Introductory.—The taking of the sixth decennial Census on the 26th February 1931 with which this Report deals, completes half a century of Census administration in Central India. A partial Census of certain portions of Malwa was taken by Sir John Malcolm in 1820 but a regular Census covering the whole Agency dates from 1881. The first Census was far from a success and the enterprise was fraught with insurmountable difficulties owing to the inefficient state of many administrations, ignorance, want of communications and general apathy. At the best the Census of 1881 was only a rough estimate and its value could be gauged from the remark of Sir Lepel Griffin who wrote that the Census returns of Central India were for comparative purposes not worth the paper on which they were written.

2. Since then great changes have taken place and the intervening decades have witnessed the opening of the country by means of improved communications, a steady rise in the standard of administration in many States, the emergence from isolation of certain tracts, a greater appreciation of the utility and value of Census and above all a growing sense of co-operation without which an undertaking like the Census is next to impossible. Concurrently with these general advancements, there has been a steady improvement in organisation and accuracy in enumeration from decade to decade and since 1901, the Census administration of the Agency has been put on the same level with the other parts of the Indian Empire. We are therefore entitled to claim for Central India the same accuracy or trustworthiness of returns as is justifiably claimed for the Indian Census as a whole.

3. *Three-fold problems of the Agency Census.*—There are however still some problems in the Census administration which demand care and attention. One of them is the treatment of non-synchronous tracts, *i.e.*, those tracts where owing to their inaccessibility or to the wild nature of the country, resort should be had to a day Census while the ordinary Census is carried out in the night. Out of a total area of 51,597 square miles, 7,535 square miles were treated as non-synchronous area. These places are inhabited by the primitive tribes like the Bhils, Gonds, and Baigas who have not yet left their jungle homes and settled in the plains. In the early days they were apprehensive of Census enumeration. Now they are used to it and give no trouble to the enumerator. The difficulty however lies in getting sufficient enumerators to visit their areas. Special arrangements had to be made in Ali-Rajpur, Barwani, Jhabua and in portions of Dhar, Rewa and Indore States. In Rewa to the south of the Kaimur, there is a large belt of forest area thickly wooded and extremely deficient in communication. Here the Baiga, the Gond and other cognate tribes live in small forest clearings leading a most primitive life. The movement of the Census officials in these regions is impeded by the presence of the wild animals though the Baiga dreads not a tiger. A second difficulty is the lack of sufficient literate enumerators in the rural areas more especially in the eastern portion of the Agency where general literacy is lower than in Malwa. A third difficulty peculiar to Central India is geographical. The excision of Gwalior and its feudatories from the Agency and the vesting of the Census administration of the guaranteed and unguaranteed holdings in the suzerain Darbar, have to some extent simplified but not completely eliminated the geographical confusion. The boundaries of many States cross and re-cross in endless ways and States like Dewas (S. B. and J. B.), Ratlam and Sailana, Rajgarh and Narsingharh are interlaced in such a way that they are comprehensible only by studying a map. Only Bhopal and Rewa have compact areas. Indore and Dhar have several detached blocks of territories and the former has outlying areas in the United Provinces and in the Mewar Residency. In the East, between the Dhasan and the Ken rivers the Bundela States are all intermixed and their fragmented parts—the Jagirs—are dotted very near to the Jumna. Further east the Chaube Jagirs are similarly scattered. From the point of Census organisation and control these have presented and still continue to present administrative difficulties demanding great care and supervision.

4. *Census Act.*—The Census is taken on the basis of an Act of the Indian legislature which, however, is not applicable to the Indian States. Its applica-

tion was limited to the administered areas and the railway lands in Central India. The States of Bhopal and Indore passed a Census Act on the lines of the British Indian Census Act and in all other States the Darbar's general proclamation served the same purpose.

5. *Co-operation of the public.*—The Census is pre-eminently a work of the people themselves and its success is entirely dependent on the measure of co-operation tendered. It is pleasing to record that there was no attempt anywhere to offer obstruction to the work. The attitude of the public was one of helpful co-operation and in many places it was characterised by considerable enthusiasm, thus greatly facilitating a successful and statistically accurate enumeration.

6. *The arrangements for the taking of the Census.*—The arrangements for taking the Census and for abstracting and tabulating the results are too technical and elaborate to be discussed here. They have been fully dealt with in the Administrative Report. Only few salient points need be mentioned here. Each administrative unit—State, Jagir or Cantonment—was placed under an official exercising general supervision, control and responsibility. A complete list of villages together with the number of inhabited and uninhabited houses (house being defined for Census purposes) in every village and town was prepared for each unit. Then on the basis of this record were formed Census blocks which are the smallest and as far as possible most compact units consisting as a rule of 40-50 houses which the person in charge—the enumerator can easily enumerate. A number of such blocks were grouped into a circle and placed under a Supervisor and the Circles in turn were comprised within a Charge which corresponded to a recognised Revenue unit such as a *Tahsil* or a *Pargana* and which was usually under the Revenue official in charge of the Revenue division. In Central India there were 322 Charge Superintendents, 4,700 Supervisors and 52,051 Enumerators. After carefully demarcating these Census divisions, and determining the agencies, the houses were numbered and the House-lists were written up. The training of the Census staff was undertaken with the issue of the preliminary schedules and this was followed by the final distribution of the requisite forms, and the general schedules on which the population was enumerated.

7. *Preliminary and the final enumerations.*—Early in January 1931, the enumerator went round his block and made a preliminary record of the inmates who ordinarily live in each house. The Census itself was the process of checking and correcting the record of the preliminary enumeration by striking out the entries relating to persons who had died or gone away and entering the necessary particulars for new-born children and newcomers, so that it should correspond with the state of facts actually existing on the night of 26th February 1931.

8. *Special arrangements.*—Special arrangements were made to enumerate people at the fair of Khajuraho, for the enumeration of the strictly military area in the Cantonments in Central India and also of Jails, Hospitals and travellers on road and for the enumeration at Station platforms and of certain trains passing through the territorial jurisdiction of the Central India Agency on the night of the Census. The military and the railway authorities rendered all possible help that was demanded of them.

9. *Provisional Totals.*—Immediately after the enumerator had completed his round in his block on the night of the Census he added up the total population of the block as ascertained by him and passed it on to his Supervisor who in turn passed on his Circle totals to the Charge Superintendent and the final totals for the State were arrived at from the Charge Superintendents' figures. In every State careful preparation had been made to bring in the returns from the different parts of the State as expeditiously as possible to the head-quarters and for this runners, *Sowars*, Motor Cars and Telegraph offices were utilised according to local needs and conditions. The first total to reach Indore was from Jaora at 5-15 A.M. on the 27th February and the last to reach was from Ajaigarh at 8-46 P.M. on 2nd March. On 3rd March, the provisional totals for the Agency were wired to the Census Commissioner for India. The Provisional figures communicated to the Census Commissioner were 6,632,909 and the final figures arrived at in the Indore Abstraction Office after checking and recounting were 6,632,790. The difference comes to only 119 or 0.0017 per cent. This reflects great credit on the State officials.

10. *Abstraction and Compilation of the results.*—The post-enumeration work was done at the Central office at Indore. It falls under three heads, *viz.*, (1) Slip-

copying, (2) Sorting and (3) Compilation and Tabulation. Immediately after the Census the enumeration books of each State were collected and transferred to Indore and on the 6th March 1931, the Abstraction Office was opened and with the arrival of the books, the work of Slip-copying was in full swing by the beginning of April. By the beginning of June all the sections had entered upon sorting and early in August compilation work was making satisfactory progress. By the middle of December 1931, every State had completed the work. The first set of the Agency tables were sent to the press on the 18th November 1931 and the last by the end of February 1932. Though the materials for the writing of the Report were being collected for some time, the actual drafting work was commenced in May 1932. The first Chapter of the Report was sent to the press on June 15, 1932 and by the end of September the press was in possession of the entire Report.

11. *The Report.*—In ushering this Report, I think few words are called for with regard to its character and scope. This is the first time in the history of the Census administration in Central India that a detailed Report has been presented, adequately meeting the needs and requirements of all the principal States and at the same time presenting as complete a picture as possible of such a complex and heterogeneous area as the Central India Agency. In doing so, I have made a complete departure from the previous practices and have run counter to the strongly expressed wishes of my experienced predecessor which he set out with considerable force in the Introduction to the 1921 Report. With all due deference to the late Colonel Luard whose knowledge and experience of Central India was very great, I have been unable to hold the view that an Agency Report is inutile. It is not necessary to argue and state the case for the necessity of a Report and I hope that this question which has been raised since 1911 will be closed for good. Only two points need be mentioned in this connection. The disadvantages of scattering the statistics of a large number of States—many of them are very small—in 35 separate pamphlets, are too obvious to be reiterated. It is next to impossible for any body—the administrator or the research worker—to obtain the requisite information easily and readily. Secondly the statistics for the States are bound to assume importance in the coming years and they should be made available in exactly the same way as for the other units of the Indian Empire. These are sufficient to justify the detailed presentation of the statistics by the principal States in the Tables volume and their analysis in the Report volume.

12. From this digression it is time I turn to the Report. One feature of the Report is the carefully executed diagrams on which depends the utility of a statistical report. Another is the detailed analysis of the figures by States and not by political charges as in the previous decades. A third is the number of appendices which it is hoped will be found useful to those who are interested in Indian ethnology. In drafting the Report I have derived inspiration from a variety of sources. It would be a most cruel punishment ever given to me if, as a compiler of the Census Report, I am asked to be original. My borrowings have been heavy—indeed too heavy. They have been necessary to cover the dry bones of the statistics and more than that to hide the poverty of my own thoughts. In the body of the Report I have tried to acknowledge my indebtedness but they are by no means complete. For statistical analysis I have relied on the previous India Reports and the various provincial reports. No one can write about Central India without mentioning Sir John Malcolm's classic book '*A Memoir of Central India*' and no apology is therefore needed in making constant references to it in the Report. I have also had recourse to that wonderful and monumental production of human knowledge—the *XIVth Edition of Encyclopædia Britannica*. Besides the books recommended by the Census Commissioner for India, I have derived considerable help from the *Tribes and Castes of the Central Provinces* and also from Peake and Fleure's *Corridors of Time* in six volumes which were kindly brought to my notice by Dr. Hutton.

13. *Cost.*—The accounts have not yet been finally adjusted as the printing of the Report is still in progress. Approximate figures can, however, be given. The total expenditure up to date is Rs. 1,15,551 to which may be added Rs. 32,000 on account of the cost of printing the Report and leave salaries. A sum of

Rs. 18,200 has been credited to Government on account of recoveries and receipts. Thus the total cost to Government comes to Rs. 1,29,355 which gives 3·7 pies per head of population.

14. *Acknowledgments.*—It would be next to impossible to specify by name all those who have contributed to the success of the operations. All the State Census Officers have worked extraordinarily well and have shown commendable zeal, enthusiasm and devotion to duty which I cannot praise too highly. There could not have been a more conscientious body of workers. A list of these gentlemen is given below :—

- | | |
|--|--|
| 1. Mr. M. A. Rashid, B.A., Bar.-at-Law, Indore. | 22. Mr. S. P. Desai, B.A., LL.B., Jhabua. |
| 2. Munshi Muhammad Mumtaz Ali Khan, Bhopal. | 23. Munshi Bala Prasad, Nagod. |
| 3. Pandit Nand Kishore Dube, M.A., Rewa. | 24. Babu Manohar Lal, Maihar. |
| 4. Bakshi Jagatram Anand, B.A., L.T., Orchha. | 25. Pandit Ganpat Rao Vyas, Barwani. |
| 5. Mr. Mir Bahadur Ali, Datia. | 26. Pandit Vishnu Pant, Ali-Rajpur, Ratanmal, Kathiwar, Mathwar. |
| 6. Mr. Rangnath Mahadeo Puranik, M.A., LL.B., Dhar. | 27. Mr. Ram Dayal, Khilchipur. |
| 7. Mr. V. G. Naik, Dewas Senior. | 28. Munshi Balmakund, Kurwai. |
| 8. Mr. V. R. Deo, Dewas Junior. | 29. Mr. J. D. Govila, Jobat. |
| 9. Pandit Makund Rao Lakkad, Samthar. | 30. Mr. S. Ali Bahadur, Manpur (British) Jamnia, Nimkhera, Rajgarh. |
| 10. Munshi Gulam Ali, Jaora. | 31. Munshi Ras Biharlal, Bundelkhand Agency Jagirs, Nowgong. |
| 11. Khan Bahadur D. F. Vakil, B.A., Ratlam. | 32. Babu Brij Kumar Sahai, Baghelkhand Agency, Minor States and Jagirs, Satna. |
| 12. Babu Raj Bahadur, Panna. | 33. Pandit Kanahaiyalal, Bhopal Minor States. |
| 13. Sayyad Gulam Abbas, Charkhari. | 34. Diwan Pratap Singh Pamar, Sarila. |
| 14. Munshi Durga Prasad, Ajaigarh. | 35. Munshi Sayyad Abdul Rahman, Pauth-Piploda. |
| 15. Mr. Debi Prasad, Bijawar. | 36. Mr. P. R. Sharma, Khaniadhana. |
| 16. Mr. S. M. Rahat Hussain, Baoni. | 37. Babu Rang Nath, B.A., Piploda. |
| 17. Pandit Gopal Sitaram Bhagwat, B.A., Chhatarpur. | 38. Executive Officers, Mhow, Nimach, Nowgong Cantonment. |
| 18. Lala Harbaksh Raiji, Sitamau. | 39. President, Residency Bazar Committee, Indore. |
| 19. Mr. Hari Singh Kothari, Sailana. | 40. Head Clerks, Agency Office, Bundelkhand, Baghelkhand and Bhopal. |
| 20. Babu Har Prasad, Rajgarh. | |
| 21. Pandit H. M. Vachhrajani, B.A., S.T.C., Narsingharh. | |

Besides these Census Officers, I must refer to the excellent work done by Mr. Surendranath Dube, M.A., Assistant Census Officer, Indore, who showed great energy and zeal in the enumeration work of Indore State and was later responsible for completing the abstraction work of that State. Mr. V. P. Pabalkar, Assistant Census Officer of Dhar with his special knowledge of the Dhar State feudatories rendered very good services throughout the operations.

15. My thanks are due to several gentlemen who assisted me in the different special enquiries. Mr. R. M. Puranik, M.A., LL.B., evinced a keen enthusiasm in the collection of ethnographic accounts of several castes and I hope the Dhar Darbar will some day find it convenient to publish them. Diwan Bahadur Janki Prasad, Secretary to the Rewa Darbar and now Adviser to His Highness the Maharaja of Rewa, very kindly placed at my disposal some interesting notes on Rewa castes and tribes which were useful in identifying many of the primitive tribes in south Rewa. I am also indebted to Khan Bahadur D. F. Vakil, Census Officer, Ratlam, for his specimens of the Bargundi dialect and for his other contributions. Mr. Puranik of Dhar, Munshi Mumtaz Ali Khan of Bhopal and the Chief Medical Officer in Central India were good enough to collect some useful data for the fertility and mortality rates. My warm thanks are also due to Diwan Bahadur K. G. Nadkar, Dewan of Dhar; Diwan Bahadur Janki Prasad of Rewa; and Rao Bahadur H. N. Gosalia, Dewan of Barwani for the facilities they gave in the carrying out of the anthropometric measurements which Dr. B. S. Guha of the Zoological Survey of India undertook at my request.

16. I would also tender my best thanks to all Ruling Princes and Chiefs and Political Officers in Central India and to the heads of State administrations for their ready and unflinching help which was never withheld from me.

17. Coming nearer home to my head-quarter Office, I have much pleasure in recording my obligation to my office staff. They have all worked with a single-minded devotion and have shown much sense of duty. Mr. Jhamman Lal Sharma with an exceptionally good record in the previous Census, joined my office as Head Clerk and after enumeration he was made the Deputy Superintendent and placed in charge of the Abstraction Office. Throughout the operations, he has worked extremely well and shown initiative, industry, intelligence and ability far above the average. A quiet worker with considerable tact he got on excellently with the heterogeneous State staff in the Central Office which in fact ran so smoothly that I had rarely any complaint. I am also indebted to him for assisting me in drafting two Chapters of the Report. Mr. M. D. Kale who also joined the staff with his previous experience again did excellent work in my office and later on he was deputed as the Senior Government Inspector. His work in the Abstraction Office has earned my warm commendation and on him fell the brunt of the Agency compilation work. The final emergence of the Tables volume from the press is due to his hard work, patience and unremitting industry. Mr. Banshi Dhar Agarwala, my steno-typist has fully justified his appointment and has proved himself to be a rapid and neat worker.

18. My thanks are also due to the Superintendent, Government Printing, India, for the excellent proofs sent to me and to the Director of Map Publication, Calcutta, for kindly undertaking to execute the work connected with the Maps and Diagrams. In this connection I should like to thank Diwan Bahadur B. C. Dube, I.S.E., Superintending Engineer, Central India Public Works Department, for placing the services of his draftsmen at my disposal and for his keen and lively interest in the work. The excellent nature of all the diagrams and maps in this Report is entirely due to the good work done by Mr. Chatterjee the head draftsman and his able assistants.

19. I cannot bring this brief review of the Census operations to a close without expressing my deep sense of obligation to my Chief Dr. J. H. Hutton, for his valuable advice, and the sympathetic treatment he has always extended to me in so many matters that I had to refer to him. I am particularly grateful to him for his kindly guidance in my impudent excursions into the fields of anthropology.

C. S. VENKATACHAR.

INDORE RESIDENCY ;

September 15, 1932.

NOTE.—Although this report is issued under the authority of Government, the author is wholly responsible for the views and opinions expressed therein.

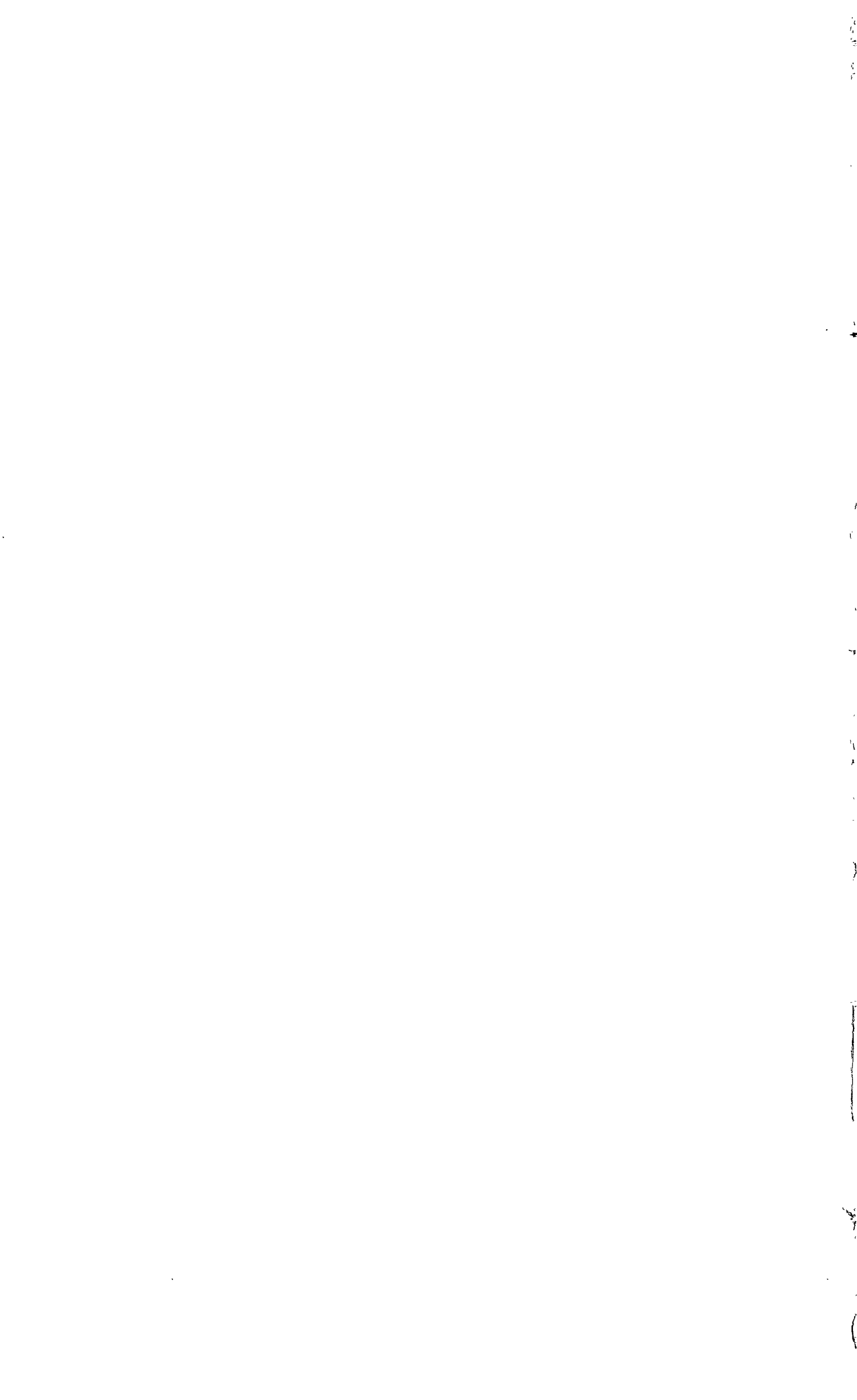

SOCIAL MAP OF CENTRAL INDIA

Scale 1 Inch to 24 Miles
 Miles 10 20 30 40 50 60 70 80

REFERENCES

- FOR DETAILED STATISTICS SEE APPENDIX A TO CHAPTER XI OF REPORT
 SCALE OF RECTANGLES 1 SQUARE INCH = 500,000 PERSONS
 REFERENCE TO NUMBERS :-
 1- REST OF SOUTHERN CENTRAL INDIA STATES AGENCY INCLUDING JOBAT
 2- REST OF BHOPAL AGENCY INCLUDING KURWAI
 3- REST OF BUNDELKHAND AGENCY INCLUDING BAONI AND KHANIADHANA
 4- REST OF BAGHELKHAND AGENCY INCLUDING BARAUNDHA

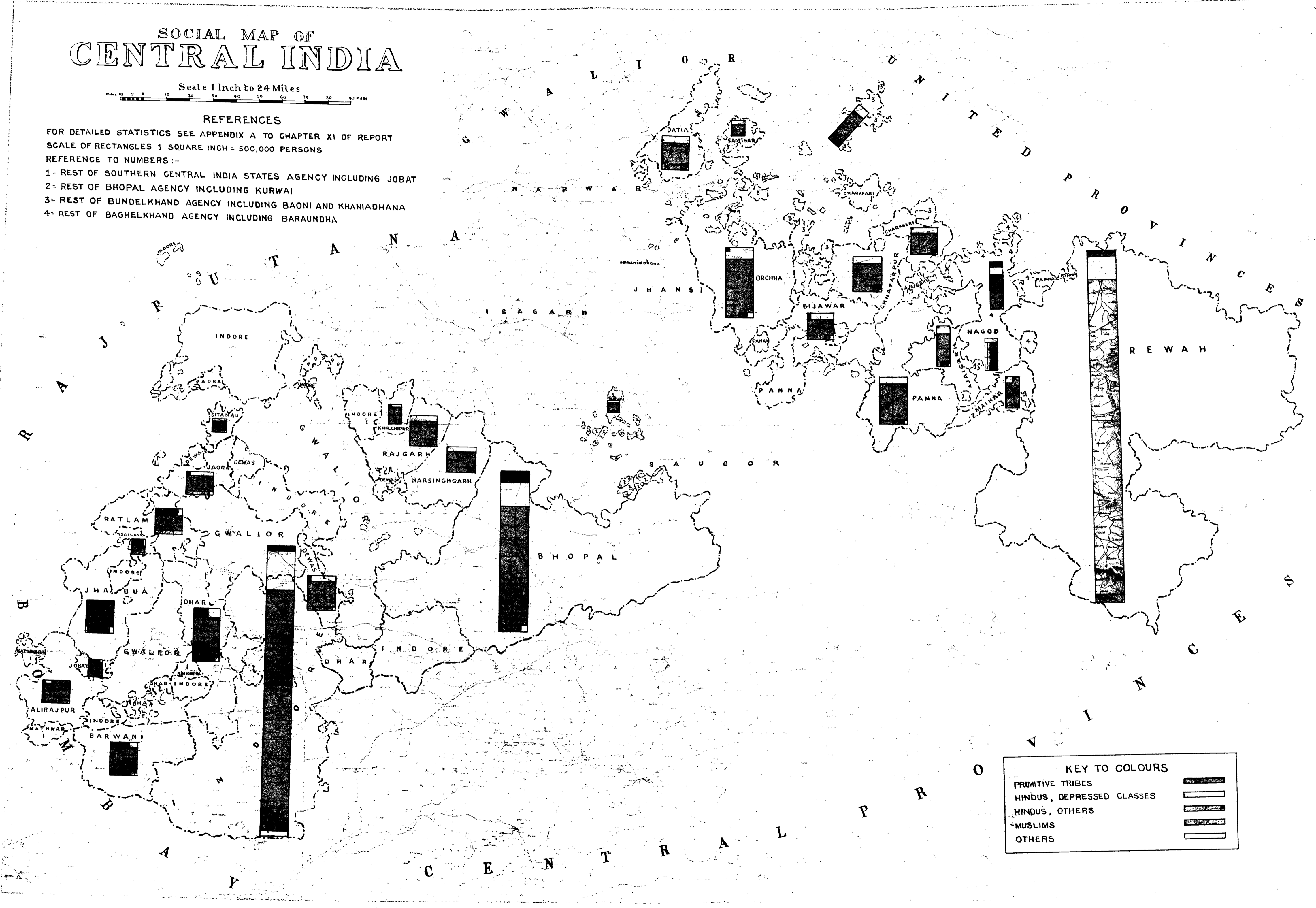

KEY TO COLOURS	
PRIMITIVE TRIBES	
HINDUS, DEPRESSED CLASSES	
HINDUS, OTHERS	
MUSLIMS	
OTHERS	

LINGUISTIC MAP OF CENTRAL INDIA

Scale 1 Inch to 24 Miles
 Miles 0 10 20 30 40 50 60 70 80 90

REFERENCES

FOR DETAILED STATISTICS SEE APPENDIX A TO CHAPTER X OF REPORT.

SCALE OF RECTANGLES = 1 SQUARE INCH = 5000 00

REFERENCE TO NUMBERS:-

- 1- REST OF SOUTHERN CENTRAL INDIA STATES AGENCY INCLUDING JOBAT
- 2- REST OF BHOPAL AGENCY INCLUDING KURWAI
- 3- REST OF BUNDELKHAND AGENCY INCLUDING BAONI AND KHANIADHANA
- 4- REST OF BAGHELKHAND AGENCY INCLUDING BARAUNDHA

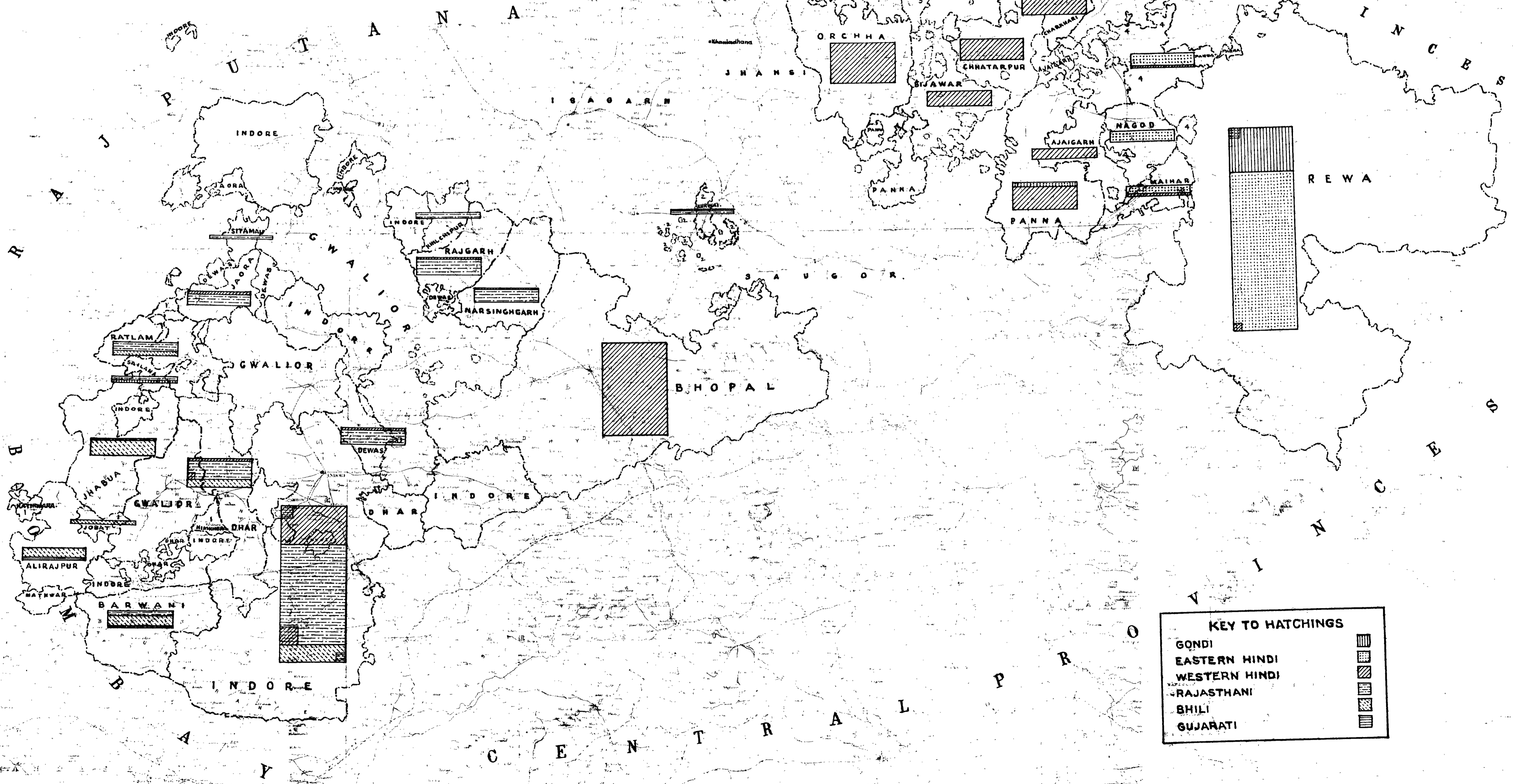

KEY TO HATCHINGS

- GONDI
- EASTERN HINDI
- WESTERN HINDI
- RAJASTHANI
- BHILI
- GUJARATI

REPORT

ON THE

CENSUS

OF

CENTRAL INDIA AGENCY, 1931.

CHAPTER I.

Distribution and Movement of the Population.

Section I.—Introductory.

Central India.—This report deals with the area under political control known as the Central India Agency which consists of a large number of Indian States,¹ 61 in number to be precise, of which 28 are salute and the remaining are non-salute States. On a map of India this area of 51,597 square miles sprawls across the central regions and its irregular boundary meets Bombay Presidency in the south-west, the Rajputana Agency in the west, the Central Provinces in east and south and portions of Gwalior and the United Provinces in the north. The Central India of official nomenclature and its exact location are sometimes not free from doubt. To some on the mention of the Vindhya hills, Central India recalls a vague association with the *Madhyadesa*, or the Midlands of the ancient times, to the more interested it connotes Malwa whose classic accounts are still read in 'A Memoir of Central India,'² and to those whose vagueness of the country increases in proportion to the distance they are away from it, it becomes undistinguishable from a contiguous British Province known as the Central Provinces. Central India as dealt with in this report has a distinct outline and identity of its own, so different actually from what it is sometimes thought or understood to be.

2. **Two main divisions: Central India West and East.**—The Central India Agency, as now constituted consists of two dissimilar tracts, approximately

Main Divisions.

Divisions.	Area in sq. miles.	Popula- tion.
Central India West .	26,742	3,486,849
Central India East .	24,855	3,128,271

equal in area, whose continuity is disturbed by the intrusion of the British districts of Jhansi (United Provinces) and Saugor (Central Provinces). Before the excision of Gwalior, Central India could have been roughly described as a great triangle, with the Narbada and Son for its hypotenuse, having for one side the valley of the Ganges and for the other the river Chambal and the Chittor hills. In its present truncated condition, it roughly assumes the shape of two separate arcs, placed across the central regions, the chord joining their two extreme ends, running from the south-west of the Vindhyas on the Gujarat border, to the north-east point of the Kaimur range.

3. **Physical features. The Narbada.**—The physical aspects of this area may briefly be surveyed by starting from the Amarkantak plateau in Rewa State where the Narbada takes its source. 'If the Indian Peninsula', wrote Sir R. Temple

¹ Excludes Khaniadhana, *vide* paragraph 17.

² The full title of this book which will be constantly referred to in the report is as follows:—A Memoir of Central India including Malwa and adjoining Provinces with the history and copious illustrations of the past and present conditions of that country. By Major-General Sir John Malcolm, G.C.B., K.L.S., London, 1824. Two volumes. Hereafter it will be referred to simply as *Memoir* and the references are to the 1824 edition.

in 1866, ' may be imagined as a shield and if any spot be the boss of such a shield, then Amarkantak is that spot. South of the Himalayas there is no place of equal celebrity so isolated on every side from habitation and civilization. To the north as well as to the east hundreds of miles of sparsely populated hills intervene between it and the Gangetic countries'. After leaving Amarkantak the Nerbada pursues a westerly serpentine course and flows in a deeply trenched valley bounded on either side by the two systems of hills which run parallel across the central regions—the Vindhya and the Bhaner hills on the north bank and the Mahadeo and the Satpuras on the south. When it enters the Agency, it forms the southern boundary of western Central India till it reaches Barwaha in Indore State. It then occupies the centre of the two parallel hill systems. Below Barwaha and up to Chikalda it is more open, the Satpuras being forty miles distant to the south. Further down before it leaves the Agency the hills close in so narrowly as to form absolutely the banks of the river. Viewed from the banks of the Nerbada, the Vindhyan hills present ' an almost uninterrupted series of head-lands with projecting promontories and receding bays like a weather-beaten coast-line.' The abrupt face of the hill ranges is to the south; their declivity and principal watershed to the north. There is no descent to the north as in the south. The plateau stretches away from the summit in gentle undulations. All the important rivers are therefore on the plateau: they flow towards the north and drain into the Gangetic basin.

4. **Malwa.**—The plateau of Malwa is a vast stretch of undulating plains, interspersed with curiously shaped low flat-topped hills and covered with tenacious black soil—a very rich loamy earth possessing an unusual power to retain moisture and renowned for its fertility. Except in those parts where the offshoots of the Vindhyas have made their thrusts, the whole of the plateau is generally uniform in character. The main rivers that traverse the plateau are the Chambal, Sipra, Kalisindh and Parbati.

5. **Central India West.**—The western portion of Central India includes the fertile valley of the Nerbada with its alluvial soil, the Malwa plateau with its black cotton soil and the inhospitable hilly tracts of the Vindhyas and the Satpuras.

6. **Central India East.**—East Central India is a low-lying tract, abruptly terminating at its southern extremity at the summit of the Vindhyan brink. It consists of two distinct territorial divisions—Bundelkhand and Baghelkhand. The physical characteristics of this region are best seen by following in the order named the principal rivers—the Sind, the Betwa, the Dhasan, the Ken and the Son. Between the Sind and the Dhasan lie the two important Bundela States, Datia and Orchha, but the homogeneity of this area is broken up by the intervening British districts. The next portion lies between the Dhasan and the Ken rivers. Immediately after the Ken rises the Panna range which traverses right across Bundelkhand from south-west to north-east. Between the Panna range and the Kaimur there is a low-lying tract gently sloping towards the Gangetic basin. Below the Kaimur is the Son which taking its source in Amarkantak flows north, occupying the same line of valley as the Nerbada. The region below the Kaimur and up to the borders of Chota Nagpur plateau is a thickly-wooded wild region, deficient in communication and in civilization and sheltering some of the most primitive tribes in India.

Compared with the West, the soil is everywhere poor. Common to hilly and low-lying parts is a light sandy soil often strewn with boulders and even the fertile soil requires irrigation. The staple crop raised in East Central India is rice and *kodon* while the more favoured West raises cotton, wheat and *jowar*.

7. **The role of the Vindhyas.**—The Vindhyas have played a most prominent part in the ethnical and cultural history of Central India. They have formed the most effective barrier across the peninsular India and before the railway and the road were driven through them, and their forests denuded, they had constituted in the very early times a real and formidable obstacle to man and his movements. Traditionally they have been associated with the extreme limit of the Aryan influence. Moreover, since the dawn of history they have sheltered some of the oldest races in India. The primitive tribes of Central India are scattered in the entire length of the Vindhyas and its off-shoots. In the present state of our knowledge we cannot say whether they are autochthones or the

survivals of a race which were driven away from the plains by the pressure of succeeding racial drifts or migration. Certain it is the hills of Central India have been the abode of man from early times: witness the cave drawings of the Kaimur hills and the industry associated with the Final Capsian culture in the Vindhya.

That part of peninsular India which lies to the east of Central India has always been a comparatively undeveloped country till recent times. No racial movement either from the east coast side or its hinter land into the central regions was possible or could be expected. So effective has been the Vindhyan barrier that no migration took place from the south to Central India till the Mahrattas from the dry Deccan highlands over-ran Malwa and the contiguous parts. Consequently all the racial incursions and migrations have reached Central India from the northern Gangetic plain, from Rajputana and from Gujarat through the gap in the western Vindhya. The contiguity of Central India to the densely peopled places of the Gangetic doab—the centre and seat of ancient civilization and culture—and the exposed nature of the plains and their fertility, have contributed towards attracting people from these directions and the Vindhya have set a limit to every expansion from the north. The tide of migration has always spent its force against these hills.

8. Cultural complexity.—From remote times, we can discern two cultures in this region. The older, compelled by necessity, had perforce to take shelter in the hills and forests and has vainly struggled against the all-powerful culture of the plains which in its long evolution has undergone many changes and revolutions but still retains its protean character. The inter-penetration of the culture of the hills and the forest and of the plains has been going on from time immemorial. Signs, however, are not wanting which show that the older culture is fast disintegrating under the influence of the culture of the plains—the disintegration being more marked in the last two or three decades. It is only in the south-east corner of the Agency below the Kaimur hills which still remain unopened, that we can discern the primitive tribes maintaining an atrophied form of their native culture.

9. Linguistic diversities.—The ethnic and cultural diversities are reflected in the linguistic diversities of Central India. In southern Rewa, the language of the primitive Baiga or Gond has been replaced by a broken form of Bagheli. The purer Bagheli of the northern plains of Rewa gives place as we move west to Bundeli which is the language of the whole of Bundelkhand. Malwi, the principal dialect of Malwa, is a branch of Rajasthani and along the Vindhya Rajasthani impinges upon Gujarati or Bhili and the Aryan languages have spread everywhere leaving small island patches where Gondi and Korcu are trying to maintain a precariously independent existence.

10. Malwa more exposed to cultural impacts.—Malwa by its geographical position has been more exposed to cultural influences than the eastern portion. We do not know whether there was any provincial form of that civilization which has recently been discovered in the Indus valley but we know that Malwa was subject from the very early times to the influences of the later civilization that was growing in the country of the Gangetic doab and Ujjain had become in Buddhist times the seat of Indo-Aryan culture. It appears the eastern parts also came under similar influence as the remains at Bharut, now in Nagod State, Bisanagar and Sanchi point to a steady intercourse from Ujjain on the west to Magadha on the east. But with the shifting of the seat of the ancient civilization, from Pataliputra to Kanauj, the eastern part passed into the hands of the primitive tribes with the advance of forest and the decline of civilization in the plains. It was opened up for a time by the rise of the Chandel Rajputs, when there was a cultural renaissance, but the chapter closed again with the incursion of fresh foreign hordes to the contiguous fertile plains. This meant a break up of the old order and a dispersal of the people. For some time again there was an extension of the tribal rule till the Bundela clans rose to power. These tracts have remained unresponsive to progressive ideas and the nature of the country has helped them to withstand the penetration of any such ideas. The fortunes of Malwa were different. Being more exposed, Malwa had changes of masters more numerous perhaps than many other parts of India, and it was the invariable appanage to the domains of every monarch, native or barbarian, who became the master of the Gangetic plain.

11. **Three broad areas : Bundelkhand, Baghelkhand and Malwa.**—Central India, therefore, is not a compact area but it consists of dissimilar tracts, with different physical and geographical environment and complex, ethnically, culturally and linguistically. Broadly speaking, three areas may be recognised. They are Malwa, Bundelkhand and Baghelkhand. There is greater diversity between Malwa and Bundelkhand or Baghelkhand than between Bundelkhand and Baghelkhand.

12. **External Changes.**—Since the Census of 1921, several transfers and exchanges of territory have taken place affecting the constitution of the Agency. The outlying Nandwai Pargana of Indore State, situated in the Rajputana Agency, was in the previous Censuses excluded from Central India though it formed an integral part of Indore State. This anomalous position has now been changed. The Pathari (Nawab) Estate in the Bhopal political charge was transferred to Gwalior in 1921 along with the feudatories of the latter. The position of Pathari has since been declared to be independent of Gwalior and it has been retransferred to the Agency. The two villages of Sheogarh and Abheypur which were declared to be held by Rajgarh State on *Istimurari* tenure from Gwalior have been excluded from the Agency. Their area being unknown, it has not been possible to adjust the Agency area in Imperial Table I. Lastly there has been an exchange of territory between Gwalior and Indore and Dhar. The village Sundarsi which was under the triple jurisdiction of these three States, has now been wholly transferred to Gwalior which has surrendered certain other villages in exchange. The following table shows the changes that have taken place during the decade :

Gain.	Loss.
1	2
1. Area of Nandwai Pargana transferred from Rajputana Agency 37 sq. miles	1. Area of Indore and Dhar States portions in Sundarsi transferred to Gwalior 7 sq. miles.
2. Retransfer of Pathari Estate from Gwalior 29 „	
3. Area transferred from Gwalior in exchange for Sundarsi 7 „	

The net gain is 66 square miles. The area of the Agency as shown in the last report was 51,531 square miles. The total area shown in this report is 51,597 square miles.

13. **Internal changes.**—There have been practically no inter-Statal changes during the decade affecting the external boundaries of any State. In consequence of the settlement of a boundary dispute between Nimkhera and Dhar State, the latter has gained three villages with an area of 4.93 square miles. Certain changes affecting the internal administrative divisions of few States have taken place during the decade. As shown in the tables below, in the States of Rewa, Rajgarh, Jaora and Nagod the administrative divisions have been broken up to form new ones while in Bhopal and Charkhari certain areas have been merged with the others to form more convenient administrative units.

Administrative Divisions broken up.

State.	ADMINISTRATIVE DIVISION BROKEN UP				ADMINISTRATIVE DIVISION NEWLY FORMED.	
	Name.	Area in 1921.	Area taken away.	Area in 1931.	Name.	Area.
1	2	3	4	5	6	7
1. Rewa	Deosar	2,333-00	615-45	1,717-55	Singrauli	615-45
2. Rajgarh	Biaora	421-00	198-00	223-00	Napaner	198-00
3. Jaora	Jaora	167-69	55-89	111-80	} Baraoda	90-60
	Tal	185-32	34-71	150-61		
4. Nagod	Nagod	210-00	40-00	170-00	} Parasmania	143-00
	Unchehra	258-00	103-00	155-00		

Administrative Divisions amalgamated.

State.	ADMINISTRATIVE DIVISION ABOLISHED.		ADMINISTRATIVE DIVISION TO WHICH ADDED.			
	Name.	Area in 1921.	Name.	Area in 1921.	Area added	Area in 1931.
1	2	3	4	5	6	7
1. Bhopal . . .	Nizamati-Shimal . . .	1,306-22	Nizamati-Maghrib . . .	1,764-70	*1,405-65	3,170-35
	Nizamati-Junub . . .	2,189-46	Nizamati-Mashriq . . .	1,641-92	*2,090-03	3,731-95
2. Charkhari . . .	Huzur Tahsil . . .	27-14	Malkhanpur . . .	171-28	27-14	198-42
	Jujharnagar . . .	162-67	Satwara . . .	245-05	162-67	407-72
	From			To	To	
	*1. Nizamati-Shimal			Maghrib.	278-80	
	2. Nizamati-Junub			1,027-42	1,811-23	
				378-23		

Other minor adjustments which have taken place are summarised in the table below :—

Minor Adjustments.

Administrative division affected.	Area in 1921.	ADDITION.			DEDUCTION.			Area in 1931.		
		Number of villages.	Area.	Administrative division from which added.	Number of villages.	Area.	Administrative division to which added.			
1	2	3	4	5	6	7	8	9		
				INDORE.						
Tarana (including Sundarsi).	397-00	5	2-40	Gwalior State . . .	½	3-56	Gwalior State	395-94		
				NARSINGHGARH.						
Khujner	162-00	1	1-00	Chhapihera	2	4-00	Pachor	159-00		
Pachor	149-00	2	4-00	Khujner	153-00		
Chhapihera	154-00	1	1-00	Khujner	153-00		
				SAILANA.						
Bangrod	279-00	1	*	Bilpank	1	*	Sailana	53-00		
Sailana				Bangrod	36-37	
Bilpank				Raoti	1	*	Bangrod	1	*	81-55
Raoti	1	*	Bilpank
				DHAR.						
Badnawar	343-00	1	3-49	Gwalior State	346-49		
Dhar	332-50	1	1-58	Gwalior State	(363-98)		
Nalehha	128-00	3	4-93	Nimkhera Estate	335-08		
Sundarsi	4-85 (3-56)	1-½	3-56	Gwalior State	(360-83)		
				NIMKHERA ESTATE.				132-93		
Nimkhera Estate	(90-00)	3	4-93	Dhar State	(85-07)		
				CHARKHARI.						
Satwara (including Jujharnagar).	407-72	6	*	Ranipura	407-72		
Ranipura	183-23	6	*	Satwara	183-23		
				ORCHHA.						
Orchha	357-00	5	11-00	Tahrauli	346-0		
Tahrauli	237-00	5	11-00	Orchha	248-0		
				PANNA.						
Simaria	243-00	1	*	Pawai	243-0		
Pawai	*	1	..	Simaria	*		

NOTE.—Areas for items marked with an asterisk are not available. Figures shown within brackets are those reported from States and do not agree with the previously recorded figures.

14. **Administrative Divisions.**—The Central India Agency is not an administrative area. The real units of administration are the States which are bewildering in variety as regards their area, population, income, degree of internal autonomy and their relation with the paramount power. The last is regulated by treaty rights in the case of some and by certain recognised instruments in the case of others. All are, however, subject to a general political control which is exercised for the whole Agency by an officer of the political department styled the Agent to the Governor General whose head-quarters are at Indore. There are four subordinate political charges, two in the East and two in the West, each under an officer styled the Political Agent who exercises control over a group of States committed to his charge. Indore is in direct political relationship with the Agent to the Governor General.

15. **Guaranteed Estates, British Administered Areas and Manpur.**—Exclusively confined to the States in the West are the guaranteed estates, which up to 1921 were treated as separate administrative units but are now included in the territorial limits of their suzerain Darbar. Certain statistics for them have been exhibited separately in the Provincial Tables; otherwise in all the other tables they are treated as an integral part of the suzerain State. For statistical purposes and treatment, in a similar position are the British administered areas excepting the small enclave of the British Pargana of Manpur. They are either places where troops are stationed in the territories of an Indian State, such as, the Cantonments of Mhow and Nowgong or where the agent of the paramount power resides such as the Indore Residency and the Agency Head-quarters of Nowgong, Bhopal and Sutna. Though administratively these areas are under the British Government, the statistics relating to them are included in those of the States of which they form a part. Standing by itself in a separate category is the small British territory, the Pargana of Manpur, with an area of 49 square miles, on the crest of the Vindhya, mostly inhabited by the primitive Bhils.

16. **Administrative divisions adopted in previous reports and their unsuitability.**—Though the States are the real administrative units, it is unfortunate they never formed the units of presentation of Census statistics except in the Census of 1881. On the other hand, since 1891, statistics have been presented by political charges which as Census units are artificial and unstable. They are artificial for the reason that these political charges are merely convenient groupings of States and in the earlier decades even of parts of different States for purposes of political control by the political officer. They are in no sense administrative units. To take an example, the Indore Agency in 1891, included the city of Indore, seven *parganas* of Indore State, a portion of Dewas States, the Thakurat of Bagli and two detached *parganas* of Gwalior. In 1901, the Indore Agency consisted of the two Dewas States and two other Estates, while in 1911 the Agency as such disappeared altogether, the units comprised in it being merged in another political charge. Their unstability is brought out in the table below which shows the changes that have taken place since 1891, the most notable of them being the excision of Gwalior and its feudatories from this Agency in 1921.

Changes in Political charges since 1891.

1891.	1901.	1911.	1921.	1931.
1	2	3	4	5
Gwalior Agency .	Gwalior Residency .	Gwalior Residency .	Indore	Indore.
Indore Agency .	Indore Residency .	Indore Residency .	Bhopal Agency .	Bhopal Agency.
Bhopal Agency .	Bhopal Agency .	Bhopal Agency .	Malwa Agency .	Malwa and Southern Central India States Agencies.
Western Malwa Agency .	Bhopawar Agency .	Bhopawar Agency .	Southern Central India States Agency	
Bhopawar Agency .	Indore Agency .	Malwa Agency .		
Guna Agency . .	Malwa Agency .	Bundelkhand Agency	Bundelkhand Agency	Bundelkhand Agency.
Bundelkhand Agency	Bundelkhand Agency	Baghelkhand Agency	Baghelkhand Agency	Baghelkhand Agency.
Baghelkhand Agency	Baghelkhand Agency			

The process of change still continues. After the present Census, the Baghelkhand and Bundelkhand Agencies have been amalgamated into one charge and certain States from the Malwa Agency have been transferred to the Bhopal Agency. In short, the units of presentation of our statistics have undergone unceasing mutation and it is necessary to warn anyone making comparative researches in figures that the charges from Census to Census are different and great care should be exercised in using them.

17. Arrangement of administrative divisions in the Report and the Tables.—These considerations have led to the abandonment of the political charges as units both in the Imperial and the Subsidiary Tables. Every State with a population of 16,000 and over has been shown as an independent unit and statistics for all such States have been made available in all the Imperial Tables and, with few minor exceptions, in all the Subsidiary Tables. The arrangement of the States is shown below in the order in which they appear in the tables of this report.

Central India Agency.	Bhopal Agency.	Malwa Agency.	Southern Central India States Agency.	Bundelkhand Agency.	Baghelkhand Agency.
1	2	3	4	5	6
<i>British Territory.</i>	3. Bhopal.	8. Dewas, Senior.	15. Ali-Rajpur.	20. Ajaigarh.	30. Baraundha.
1. British Pargana of Manpur.	4. Khilchipur.	9. Dewas, Junior.	16. Barwani.	21. Baoni.	31. Maihar.
<i>Indian States.</i>	5. Narsingharh.	10. Jaora.	17. Dhar.	22. Bijawar.	32. Nagod.
	6. Rajgarh.	11. Ratlam.	18. Jhabua.	23. Charkhari.	33. Rewa.
	7. Rest of Agency.	12. Sailana.	19. Rest of Agency.	24. Chhatarpur.	34. Rest of Agency.
2. Indore.	(a) Kurwai.	13. Sitamau.	(a) Jobat.	25. Datia.	(a) Kothi.
	(b) Other States.	14. Rest of Agency.	(b) Other States.	26. Orchha.	(b) Sohawal.
				27. Panna.	(c) Other States.
				28. Samthar.	
				29. Rest of Agency.	

Lastly comes Khaniadhana. This State is administratively outside the territorial limits of the Central India Agency but under the orders of the Government of India it has been included for Census purposes in Central India. It will be seen above there are still a number of units which cannot find an independent existence in the arrangement adopted and they have been shown as a group in the political charge in which they lie. This is due to the prevalence of a large number of small units whose population is below 16,000. They number 29 in all. The units which are grouped together are detailed below :—

Agency.	Serial Number.	States and Estates comprising the group.
Bhopal	7(b) Other States .	{ 1. Muhammadgarh. 2. Pathari.
Malwa	14. Rest of Agency .	{ 1. Panth-Piploda. 2. Piploda.
Southern Central India States.	19(b) Other States .	{ 1. Jamnia. 2. Kathiwara. 3. Mathwar. 4. Nimkhera. 5. Rajgarh. 6. Ratanmal.
Bundelkhand	29. Rest of Agency .	{ 1. Alipura. 2. Banka-Pahari. 3. Beri. 4. Bihat. 5. Bijna. 6. Dhurwai. 7. Garrauli. 8. Gaurihar. 9. Jigni. 10. Lugasi. 11. Naigawan-Rebai. 12. Sarila. 13. Tori-Fatehpur.
Baghelkhand	34(c) Other States .	{ 1. Bhaisaundha. 2. Jaso. 3. Kamta-Rajaula. 4. Pahra. 5. Paldeo. 6. Taraon.

The total population of these minor States is 134,369. In other words detailed statistics are available for 98 per cent. of the total population dealt with in this report. In the treatment of the minor units, the only exception made is in favour of the British Pargana of Manpur. Hitherto its statistics were included in the political charge in which it was administered. As it does not form part of any Indian State¹, its figures have been shown in all the Tables as a separate unit, independent of its political charge.

18. Their characteristics. (i) incompact and scattered.—Having detailed the administrative divisions which have been adopted for the presentation of our statistics, we may notice some of their characteristic features. One of them is the great dissimilarity in their size and their scattered and incompact appearance. Excluding the British Pargana of Manpur but inclusive of Khaniadhana, the area of the Agency is 51,548 square miles. Out of this area, the three States of Bhopal, Indore and Rewa together account for 29,420 square miles and cover slightly over one half of the total area. The remaining area is fragmented and divided amongst 59 States and Estates. The present administrative divisions are a legacy from the first quarter of the 19th century when the States in Central India (to quote Lee-Warner) ‘ presented the appearance of a sea suddenly petrified while in a condition of stormy unrest and disquietude ’. All over Central India they tell the same tale. We see Malwa is principally parcelled out by the two important Mahratta States of Gwalior and Indore and to a lesser extent by the States of Dewas and Dhar. The rest of Malwa with the exception of Bhopal and Jaora, is divided in various fragments amongst the different Rajput principalities. In the East the States of Datia and Orchha are separated by the intervening British territories but both are fairly compact. The fragmentation is most marked between the Dhasan and the Ken. These States arose out of the parcelling of the territory by the descendants of the Bundela Chief—Raja Chhatrasal. Further on in Baghelkhand Rewa is large and compact.

19. (ii) interlacing of territories and jurisdictions.—Attention may be drawn to the 2 maps which form the frontispiece to this report to emphasise how we do not and indeed cannot see the peculiarities of the administrative divisions in any ordinary map of Central India. Of what we actually see, one or two things are clear. Rewa, Bhopal, Barwani, a great part of Orchha, Ali-Rajpur and few others are compact, well-knit areas. States like Indore, Dhar, Dewas, Panna, Charkhari, etc., consist of blocks of territories separated by intervening portions of other States. But what we fail to see, and this is a second characteristic of the administrative divisions, is the extraordinary interlacing of jurisdictions in which the boundaries cross and recross, producing a veritable maze. So intermingled are the territories in some cases, that it is difficult to know the exact position and they baffle description. Typical of such cases, are the States of Dewas (Senior and Junior), Sailana and Ratlam, Rajgarh and Narsinghgarh, Panna, Ajaigarh and other minor states in the East. The majority of the States in Central India are a medley of interlaced territories and the Agency itself is a mosaic of fragmented sovereignties.

20. Administrative divisions and demography.—It is pertinent to enquire what bearing these facts have on demography. We have noticed how diverse and varied are the administrative divisions. They also connote different standards of administration. The system of land-tenure varies from place to place and so do the educational and other facilities. The interlaced jurisdictions have a hampering effect on the movement of trade or on migration between parts of contiguous areas. In the discussion of figures factors which influence them will be noticed in the relevant chapters. Here it is only necessary to state the fact that the administrative factor has some share in influencing the demographic data regarding the growth of population, urbanisation, migration, literacy, etc.

21. Natural Divisions.—As for comparative purposes, administrative divisions are not convenient, India has been divided into several natural divisions and two of these divisions, Central India West and Central India East, fall in this Agency. In 1901 and 1911, the Agency was divided into 3 natural divisions : the plateau, the low-lying tracts and the hilly regions. The plateau included the whole of Malwa up to the Narwar district of Gwalior. The low-lying portion

¹ As these pages are passing through the press, the British Pargana of Manpur has been handed over to Indore State.

comprised the northern portion of Gwalior and the eastern part of the Agency up to the Kaimur range. The hilly tracts included the Vindhyan system along the entire length of its range in Central India together with its off-shoots and the region below the Kaimur. The hilly division was far from satisfactory as it included areas of different jurisdictions and of different parts. With the excision of Gwalior, only two natural divisions were retained in 1921, *i.e.*, Central India West and Central India East. Though this gives approximately equal areas and keeps apart the identity of the two dissimilar tracts, yet the division is not quite happy and is not free from disadvantages. The hilly tracts, the Narbada valley and the plateau are all clubbed together. Similarly, in the East, the comparatively fertile tracts of the northern part are mixed up with the hilly regions of the south, with the Panna hills, and more especially with the hills and forests of southern Rewa. In spite of these serious objections the same divisions have been maintained to facilitate comparison with the previous figures and to avoid further changes involving confusion in comparative figures. Nevertheless the broad distinction prevailing in the two divisions is sufficiently brought out. The West, with its plateau and the Narbada valley, is fertile. The climate is mild and equable in the plateau though warm in the valley below. The mean annual rainfall in the West is 33·4 inches. The whole of the area is a favoured region and is generally free from seasonal calamities. The East has a poorer soil, enjoys more rainfall and less equable climate. The average rainfall of this region is about 40·5 inches. It is on the whole a less favoured region and is subject to drought and scarcity.

22. Village institution and Land tenure.—Central India is predominantly an agricultural area. Nearly 75 per cent. of the population live on agriculture and are scattered in 23,252 villages. Their outlook and activity in life is coloured by the village and its time immemorial institutions and no factor in the account of the people is so important as the village and the agricultural tenures.

Village institutions in Central India have a deep root in the remote past and amidst the shifting scenes of anarchy and constant changes of masters, they have survived with their vitality unimpaired. It is this vitality that astonished and drew forth the encomiums of their observers. Successive rulers (observed Malcolm), just or tyrannical, might have disturbed them but not destroyed them.

23. To get acquainted with the land-tenures ¹ in Central India, let us consider briefly how the villages arose. Throughout Central India the tradition is the land once belonged to the primitive tribes who practised little or no cultivation. Their utmost knowledge was the shifting cultivation, still resorted to—though on the sly—by the Baiga and other primitive tribes, known as the *dahya* cultivation. We do not know when the earliest colonization took place. According to one authority the Chedis, an Aryan tribe, are stated to have occupied the present day Bundelkhand but as the Vindhya are not mentioned in the early Vedic literature, it is not unreasonable to suppose that there was no colonization in the Vedic period but before the rise of Buddhism, we begin to read of the Aryan kings of Ujjain or Avantika. The country must then have been opened in parts and villages formed and in this connection it is interesting to read from the Arthashastra of Kautilya that villages should be constructed either by inducing the foreigners to immigrate or by sending the excessive population from over-populated centres. It also lays down that villages should be formed to consist of not less than 100 families and not more than 500 families of agricultural people of Sudra caste. In course of time as colonization and settlement took place there arose that form of village some of the outlines of which are still to be seen all over Central India where the cultivators were practically owners of their several family holdings, living under a common head-man with certain common officers and artisans who served them. The Raja had his own private lands but as a ruler of the whole country his right was represented not by a claim to general soil ownership but by the ruler's right to the revenue, rates, cesses and the power of making grants of the waste. In such a village there was very little room for any variety in tenure for each was the master and manager of his own holding so long as he performed the obligations that were laid on him. It was natural that where there were a large number of loose aggregates engaged in cultivation they should have one man responsible in the village through whom they should elect to deal in all fiscal and other matters

¹ In this and the next two paragraphs, certain statements have been freely drawn from Baden Powell's *Land System in British India*.

appertaining to their village. From such necessity arose the village head-man or a *Patail* as he is known in Malwa and he was allowed an official holding of land known as the *Watan*. This regularly became an institution for the honour it conferred and its stability. Associated with the *Patail* were a staff of village servants and functionaries—theoretically twelve in number—known as *Bara Balauti* in Malwa. In the former days some of them were paid in kind and some were remunerated by *Watan* holdings of land. The village was a self-contained unit and for a classic description of this village constitution, particularly in Malwa, the reader is referred to *Memoir*. The village constitution was much simpler in these parts which were under tribal rule or which were not opened up by colonization.

24. On this simple edifice other practices and tenures have been superimposed, especially in those parts where the direct effect of the Mahratta and Muslim rules has been felt. The eastern parts never came under the effective rule of these powers. They have enjoyed comparatively a greater immunity and consequently their institutions have not been subject to much modification by outside influences. One significant change that came over everywhere was the assertion of the right of the ruler to claim sole ownership and proprietorship of the soil. This later development perhaps arose at a time when almost all the ruling houses, Rajput or Mahratta, had been established by conquest in the last few centuries. Whatever may be the origin or the validity of such claim from a theoretical point of view, the prevailing practice is that the ruler of a State in Central India—whether Mahratta, Rajput or Muslim—is the sole owner of the *Khalsa* and the revenue paying land of the State. By asserting the right of ownership over all land, the rulers began to treat their *ryots* as their tenants except in the case of the holders of special grants which the ruler did not ordinarily revoke. The result was that private rights were slowly extinguished. By gradual desuetude they were rarely asserted and historical causes and some instances of oppressive assessments further hastened their extinction.

25. The accretion of other tenures dates from the time of the Muslim rulers. The Moghals imposed their system in the more exposed open country and the partially controlled jungle tracts and with that wise policy of discretion that characterised the Moghals in the greater part of their rule, they left such of the Rajput possessions free as had accepted their over-lordship and suzerainty. To collect the revenue local agents were required and thus arose a class of *Zamin-dars* also known in Malwa as *Mandlois*. Both under the Moghal and Mahratta rulers, further alienations took place. For example, there were the grants known as *jagirs* which at first were for the life-time of the grantee and resumable with the office. They are given even now as a mark of favour or for services rendered. Grants were also made for charitable purposes and the tendency in either case was towards their perpetuation and becoming hereditary. Another curious class of tenure, peculiar to Malwa, is known as *Girassia*, held by the formerly dispossessed Rajput local chief.

26. We may now state some of the salient points about the land-tenure in Central India. The State claims sole proprietorship of the soil. The land-tenure falls broadly under two classes: *Khalsa* in which land is held on lease directly from the State and alienated lands such as *jagir*, *muafi* or *istimurar*, the last being given in fixed quit-rent in permanent settlement. Alienation is much more marked amongst the Rajput principalities in western Malwa and in parts of the East. The prevalence of feudal system and the necessity of providing maintenance to the cadets of the ruling house, are responsible for this alienation. The position of the tenant may be stated thus. In most of the States he has no recognised right of occupancy; neither has he the right to sell, mortgage, or otherwise alienate his holding but in many places he has a prescriptive claim to such rights so long as the State does not choose to interfere with it, or on such conditions and restrictions that the State may choose to impose. Generally speaking the occupancy rights are strong by continued possession and in well-conducted revenue administrations the tenant is rarely disturbed in his possession. Land is let out on lease on a yearly *patta* unless there is a fixed period of settlement in which case he is allowed to hold his land for the term of the settlement at settlement rates which are liable to be enhanced in some cases, if he has intensified cultivation during the period of settlement.

27. Curiously enough, village institutions which had weathered incessant storms and convulsions in the countryside, began to disintegrate and decay when

peace began to prevail after the first quarter of the nineteenth century. The earlier powerful principalities and the rich provinces of the Empire, had disappeared and in their place had sprung up a few larger States and a host of smaller ones which the dispossessed managed to retain. The imposition of paramountcy made it impossible for any of them, big or small, to enrich their possessions by territorial acquisition. They had to be content with their existing possessions and the revenues they yielded. Gradually there arose that most objectionable class of *Ijardars* or revenue farmers who had to pay a contracted sum of revenue collection for the area farmed out to them. This system began to thrive owing to the weakness of government in the States, to mismanagement, or at times to a spirit of innate conservatism to introduce a well-organised revenue system. In most places it has now died a lingering death and in some instances during the present decade.

The imposition of a speculative middle man whose sole interest was commercial and who was profoundly disinterested in the village and its organisation killed the living organism of village life. The State was interested in the revenue and the *Ijardar* in his profits. The traditional ties that linked the village with the ruler were sundered. The village came to be looked upon as a mere unit and source of revenue and not a conservator of tradition, possessing a healthy outlook on life and giving strength to the body politic.

28. In the last decade or two, changes have taken place bringing about a further disintegration in the old village system due to two causes—administrative and the changing spirit of the times. The administrative systems of the States are being overhauled to suit modern ideas of government and modern systems of land revenue administration and settlement are sweeping away older practices. In making these changes, attempts are sometimes made to garb old institutions with modern raiment. It is doubtful whether they can thrive in their nativity in the modern soil. The changes in the institution itself are inevitable and in certain directions even desirable. Autonomous local institutions of the type that have prevailed for ages cannot thrive amidst a centralised system of administration whatever may be the complexion of the latter. The *Patail* is no longer the fountain of authority. His place has been taken by the functionaries of Government. Even his office has lost its traditional honour. Above all the village is no longer a self-contained unit. The villager's requirements are met more and more by the *hats* or weekly markets which are held all over Central India. It is amazing how cheap imported articles and trinkets are finding their way to the remotest *hats* and thence to the villages. An exception to this is the country below the Kaimur hills. This is entirely due to the want of communication and thick forests. There the Baiga or the Gond still does not use the Swedish matches and one has to forego the luxury of kerosine oil and a Dietz lantern. Slowly too the spirit of individualism is asserting itself. The improved means of transport has annihilated distances and brings the villager or the hillman, once cabined and confined to his village or to his mountain haunt, to the centre of life and civilization and to urban areas. The landless is not content to sulk or toil in his village. In times of economic stress he is no longer content to remain quiet and helpless: the call of the factory or the town is within his knowledge and hearing. To the less venturesome Malwa affords employment; the more ambitious may even stray to the outside world. The fact is it is no longer true that the States sheltered in inaccessible parts have remained little unchanged. Their social structure is in a process of transition, influenced by changes that are taking place elsewhere and it is yet difficult to say whether the process of disintegration will culminate in a more harmonious synthesis.

29. **Communications.**—A noticeable thing that would strike a sojourner in the States of Central India is the absence of railway communication in most parts. In the West there are only 4 States—Bhopal, Indore, Jaora and Ratlam—whose capital towns are on the railway. None of the other State capitals can directly be reached by railway. No part of the States of Barwani, Ali-Rajpur, Rajgarh, Narsinghgarh and Khilchipur, is traversed by railway at any point. Throughout the Narbada valley from the Gujarat borders to Bhopal there is no railway communication excepting the short distance traversed by the Rajputana-Malwa Railway through the Nimar district of Indore and by the Itarsi-Bhopal section of the Great Indian Peninsula Railway. There are many places in the interior which are sometimes more than 100 miles away from the nearest railway

station. In the East communication is still meagre. Only one State, Datia, has its capital connected by railway. No other State in Bundelkhand is effectively served by railway communication. In fact the Jhansi-Manikpur section of the Great Indian Peninsula Railway which at either end connects two trunk systems of communication entirely lies in British Bundelkhand and provides only one important station—Harpalpur—which is the outlet for a large part of Bundelkhand Agency. Further east the Jubbulpore-Allahabad section passes through the gap between the Bhaurer and Kaimur hills traversing the territories of Maihar, Nagod and the most westerly portion of Rewa at Sutna which is the only outlet to the country between the Ken and the Son. The Katni-Bilaspur section of the Bengal-Nagpur Railway passes through the southernmost portion of Rewa State, cutting a small segment in the Sohagpur Tahsil of that State. This line serves the collieries at Umaria. A branch line from Anuppur on this line to the borders of Korea State has been opened since 1927 and is known as the Central India Coalfield Railway. All the vast area lying to the north of the railway bounded by the Kaimur on the west and the Mirzapur district in the north-east is an unopened tract, extremely deficient in communication at all times.

30. On the whole it cannot be said that Central India is sufficiently well-served by railway communications, the want of which has handicapped the development of the States and tended to isolate them. Bundelkhand and Baghelkhand have no doubt from a very long time been closed for outsiders owing to the nature of the country and their inaccessibility. Not so is the case with Malwa. There has been a constant intercourse between the plateau and upper Hindustan. In the Moghal times it was a high way for the Moghal armies towards the Deccan or towards Berar or Gujarat. The route was not closed with the decline of the Moghal power for the Mahrattas immediately entered Malwa from Maheshwar on the Narbada and on account of their constant intercourse with the Poona Court on one side and with Delhi on the other, they kept open the old routes. After the break-up of the power of Holkar and of Scindhia their connection with the Deccan and upper India politically ceased and they were confined within their territorial acquisitions in Malwa. The Narbada valley became a more important route to the Deccan. Malwa ceased to be on the high way when railway communications were opened.

The earliest of the two great trunk lines that radiate from the west coast to northern India, was taken through the Narbada valley to Itarsi and thence to Jubbulpore from where a connection was obtained at Allahabad on to the trunk line from Calcutta to Lahore. From Itarsi, later on forked the Itarsi-Bhopal section which was constructed with the financial help of Bhopal State. After leaving Bhopal, the extension of this line skirts round the Malwa Plateau, takes a northerly course through Jhansi and touches the extreme northern point of Western Central India and of Gwalior State at Gwalior. The other trunk line which reaches Central India through Gujarat just touches at the extreme western points in Malwa and runs into Rajputana. To obtain an idea of the distribution of railway communication in the West, imagine a triangle with the Vindhya as the base and Gwalior as the apex. The whole of the area included in this triangle is served by the two trunk lines at few points on the extreme west and east. Bhopal on the east and Ujjain through Nagda and Ratlam on the west provide the inlets

Railway mileages in States.

State.	Mileage.	State.	Mileage.
1	2	1	2
Rewa	163-1	Nagod	15-3
Indore	132-4	Samthar	11-2
Bhopal	105-0	Dewas (Junior)	9-3
Jaora	53-7	Sohawal	9-0
Maihar	33-0	Kurwai	8-5
Ratlam	31-3	Panna	8-5
Datia	29-6	Taraon Jagir	5-3
Orchha	24-3	Alipura Jagir	4-7
Jhabua	20-2	Khaniadhana	3-6
Sailana	19-6	Kothi	1-2
Dewas (Senior)	15-6	Garrauli Jagir	1-1

into the interior. The Kotah-Baran section is left out as it is not in the Malwa plateau and entirely lies in north Gwalior. We are primarily concerned with two lines, *viz.*, Bhopal to Ujjain and Ajmer to Khandwa which open up the interior of the Malwa portion of our triangular area. The first of these is broad-gauge and connects up the broad-gauge trunk lines at either end. The second is a metre-gauge line and intersects points on the broad-gauge lines. This break in gauge at either end has its great disadvantages in times of export season, famine and generally in the transportation of goods to long distances which do not break bulk. The

metre-gauge line taps the richest portion of Malwa and carries away goods from the chief distributing centre of Indore. The total railway mileage is 707, giving a ratio of 1 mile of railway to every 73 square miles of the country. The marginal table shows the railway mileage in the different States.

31. For various reasons the expansion of railway in the States has not made so much headway as the economic development of the country would require. In the early days of railway construction more attention was naturally paid to British India and the States came into the picture only when they lay on the Imperial or strategic lines of communication. Malwa and Bundelkhand as stated above did not lie on the main route to north. The foreign nature of the jurisdiction was perhaps a hindrance. Other considerations like the financial help and prohibitive cost of certain routes may also have influenced the policy of construction. It should also be noted that some of the States at times disliked the railway for fear of their territories getting accessible and they were not prepared to exchange their life of isolation to one of constant intercourse with the outside world. Above all lack of inter-Statal co-operation, the extraordinary interlacing of territories and jurisdictions and the reluctance of the States to join in any collective schemes have effectively and adversely operated against the internal development of communications in Central India. Economically the various parts of the Agency will not become rich unless the means of communication are improved, markets are obtained, grain and cotton are easily transported, and more people are attracted. A glance at the map will show how large areas in Malwa, the fertile cotton-growing tract south of the Vindhya, the rich forest area with coal, mineral and other forest produce to the south of the Kaimur, the untapped mineral resources of Bijawar and Panna hills, still await exploitation by improved means of communication.

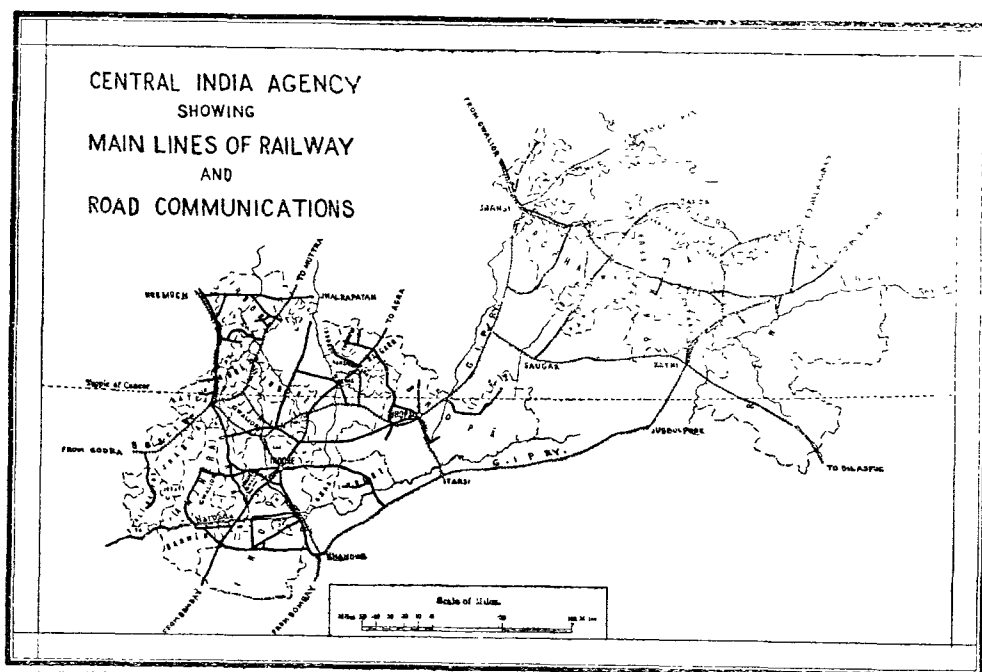

32. Central India is better served by road communications and different parts of the Agency which are poor in railway communications are linked up by good metalled roads. Some of the trunk roads were constructed from military considerations. The Bombay-Agra road was a very important trunk road before the railways and so was the Nimach-Mhow road which gives accessibility to the edge of the western Malwa plateau. The Great Deccan road from Mirzapur to Jubbulpore through Rewa and Maihar was the highway from the Upper Indian Plains to the Narbada valley. The Nowgong-Sutna road is the only means of communication that opens up the whole length of Bundelkhand. After the Mutiny, more roads were opened in Malwa. Though arterial roads are few, a large number of feeder roads were constructed within the State limits to join the main routes. The total mileage of metalled roads is 2,670 and that of the unmetalled roads is 1,423, giving a ratio of 1 mile of metalled road per 19.3 square miles of the country.

The small Jagirs in Bundelkhand and Baghelkhand Agencies, the Minor Estates in the Vindhya, possess no roads and the States of Ali-Rajpur and Jhabua are still directly inaccessible by road. In many of the smaller States there is only one metalled road which usually connects the capital town with the main line of communication. Generally the interior of a State is badly served with communication though there are in places fair-weather roads which are serviceable in the greater part of the year. In most of the States of the Southern and Malwa Agencies, the interior is not easily accessible and communications are still meagre and backward. In the East the deficiency is equally marked. The whole of the northern portion of Orchha State is deficient in communications. The Rewa State for its area has insufficient roads. There are no roads in the southern division of that State. The state of Indore, both on the plateau and below the Vindhyas, is well served by good metalled roads. The marginal table shows the mileage of metalled roads, maintained in some of the principal States. There is plenty of room for

Mileage of metalled roads in principal States.

State.	Mileage inclusive of any maintained by the Imperial Government.
Administered Areas.	37
Central India West.	1,735
1. Indore	780
2. Bhopal	298
3. Rajgarh	100
4. Narsinghgarh	77
5. Ali-Rajpur	33
6. Barwani	48
7. Dhar	185
8. Ratlam	36
9. Jaora	45
10. Jhabua	22
Central India East.	899
11. Ajaigarh	41
12. Chhatarpur	127
13. Datia	45
14. Orchha	65
15. Panna	116
16. Rewa	250
17. Maihar	56
18. Nagod	55
19. Bijawar	44
20. Charkhari	40

the development of feeder roads and for the opening of backward tracts. Without them there will be no free movement of agricultural produce and of trade.

In the last decade there has been a great extension of Motor services on the roads in Central India. They are passenger services plying from the nearest railway station to the interior or between two towns. In some places the Motor services are competing with the railway traffic.

33. Industrial and Economic.—A regular and systematic industrial survey of the different parts of Central India has not yet been undertaken and hence much of our information is indefinite. The evidence available so far goes to indicate that the prospects of industrial development are poor. Amongst other factors, industries depend to a large extent on abundant raw materials, communication and capital. Cheap power and convenient termini at the lines of transport facilitate the distribution and production of industrial products. In the previous Section we have seen that communications are meagre judged by the economic needs of the country. Capital, for some reason or other, is notoriously shy in coming to States, though there are one or two obvious exceptions. So far no sources of cheap power have been discovered in any part of Central India to assist the growth of industrialisation. Lastly, Central India is deficient in one kind of raw materials—minerals. The only Coal mine worked is that at Umaria in the State of Rewa. Iron ores of any quality are non-existent and the indigenous iron-smelting industry has been ousted by cheaper imported steel and iron articles. No gold mines are reported and the diamond mining industry which persists in Panna enjoys so far more a reputation than for its output and economic value. 'The great Vindhyan system provides incomparable sandstones and lime-stones' and they ought to be of immense value. Some of the great architectural glories of Central India have been of Vindhyan stone. The early Buddhistic monuments at Sanchi and Bharut, the magnificent tenth century temples at Khajuraho, the earlier and later buildings in Gwalior Fort, the Pathan monuments at Mandu and even the Moghal palaces, mosques and other fine buildings, vividly impress upon us in what wonderful way the Central Indian building materials were utilised by the master builders of the past. The Vindhyan series provides lime and cement which are closely associated with the building industry. They are worked at Maihar and at Sutna.

If the mineral resources of Central India are poor, its natural and agricultural products are more abundant. All along the Vindhyas and its off-shoots there are extensive forests and if scientifically conserved, they should provide

various kinds of wood and timber. The sylvan industries, such as the collection, utilization and transportation of natural or wild products, are in a primitive and unorganised stage. Their collection is still in the hands of the primitive tribes of the Vindhya and of south Rewa. The only industry that has made some headway—particularly in Malwa—is textiles. Malwa is a cotton growing area and to meet local necessities ginning presses have been established. No industrial statistics were compiled in the present Census but according to the last report, there were 101 ginning factories. The first Cotton mill in Central India was started at Indore about 60 years ago. There are now 7 mills at Indore with 164,653 spindles at work and 5,244 average looms with an invested capital of 68 lakhs of rupees and employing nearly thirteen thousand skilled and unskilled labour.

34. Thus the natural scope for industrialization is limited and other considerations militate against it. First of all there must be a demand for such a policy. The demand for it can come from the class which has surplus capital to provide or from the middle class which seeks employment from the over-crowded professions. Both of these are absent in these parts. Secondly organised industries working throughout the year require a supply of efficient labour. Central India is by no means a densely populated part. The population is moderate in parts and sparse in many places. Nowhere is there any great pressure on the soil. There is in fact no sign of hunger for land. The primary consideration is the raising of food and agriculture absorbs all available labour. Agriculture can ill afford, even if it could, to have its labour withdrawn and concentrated in industrial centres. It is debatable how far industrialization is a panacea for economic ills in the backward areas of Central India.

35. The main industry of these parts is agriculture and it is more profitable to invest capital in scientific agriculture and side by side revive, encourage and expand the village and cottage industries which have existed for a long time and are now in a process of decay. In some cases the process of decay is natural and inevitable. Many industries which were once in a flourishing condition were intimately bound up with the courts of the rulers. The colour and pomp of their courts are giving place to the more subdued but drab modern tastes. The demands of the common people also are undergoing rapid changes. Hence the languishing of the industries and the dispersal of the skilled artisan classes and their absorption in other occupations in life. The once famous tie-dyeing industry of Central India, the fine muslins of Sarangpur, Sehore and other places, the artistic lac-industry and such others have all suffered in decay owing to competition or neglect, or to a change in taste and ideas.

With the improvement of agriculture in the right direction, we may look forward to increasing prosperity. The resulting benefit would almost certainly out-weigh the loss of poppy as a staple crop. In former times it is said the prosperity of Malwa depended on poppy cultivation. For some time it has ceased to be a staple crop in Malwa. In 1906-1907 the area under poppy cultivation in Central India was 160,112 acres. The China trade began to diminish in 1907 and finally stopped in 1913. In 1915-1916 which was the year of lowest production it was 1,449 acres only. In the decade from 1920-1930, there has been a revival of production owing to the agreement of poppy production between the producing States and the Govern-

Area under Poppy cultivation.

Year.	Acres.
1	2
1920-1921 . . .	15,464
1921-1922 . . .	15,828
1922-1923 . . .	27,441
1923-1924 . . .	19,443
1924-1925 . . .	14,828
1925-1926 . . .	11,549
1926-1927 . . .	12,462
1927-1928 . . .	10,220
1928-1929 . . .	11,238
1929-1930 . . .	10,120

ment of India. The marginal table gives the acreage under poppy from 1920 to 1930. It will be seen the highest acreage of 27,441 in 1922-1923 was only one-sixth of the area under poppy in 1906-1907. The worst adverse effects arising out of the restriction of poppy cultivation were felt before 1920 but the problems arising out of them exist and await a favourable solution. Opium is generally cultivated in a good class "garden soil" and is well-irrigated. The cultivator gets ready cash thus enabling him to finance other cultivation. He has also not to seek a market and the prices are stable. The problem is one of finding a suitable substitute crop which could be profitably

grown in the soil in which the poppy has previously been grown. In this and in other measures for the rehabilitation of rural areas, the States can render great

help. Superstitions such as it is unlucky to grow particular crops have to be replaced by enlightened ideas. Adequate facilities are necessary for the spread of well irrigation. Diffusion of general ideas regarding simple but scientific methods of agriculture is of great benefit. A new orientation is also needed towards the policy of internal customs wherever it bears harshly on cultivators and prevents them from having access to markets. A heavy customs duty on staple agricultural crops strikes at the base of economic prosperity by depriving the producer of outside markets and competitive prices for his produce. The question of internal customs is linked up with the revenues of the States but the tendency in future will probably be in the direction of an economic union of the States.

The economic condition of the States—whether they are the more progressive ones or those who are just emerging out of their isolation—is in a state of transition. An intelligent and consistent policy towards rural reconstruction, infusion of vigour and life in the village and its institutions, an enlightened policy of rural economy and organisation of small industries, will go a long way in the economic prosperity of the States.

36. Scope of the Report.—A word may be added as to the scope and limitation of this report. Statistical analysis of an area like Central India gives rise to peculiar difficulties. The presence of many diverse administrative units makes it impossible to carry the discussion to all the units. The States on the other hand are the real administrative units and their figures alone are worth consideration. This may end in desultory conclusions and cumbersome presentment of facts without any composite picture. Again to restrict the presentation of figures for the Agency as a whole is not at all illuminating. Rather they convey no intelligent meaning as Central India is a mere geographical expression. The general plan adopted in this report has been to carry the discussions into the more important and representative units so as to secure as adequate a picture as possible. The treatment of the subject matter in the first six chapters of the report labours under one serious limitation. There is a total absence of vital statistics in this area and without it any discussion or closer analysis of Census statistics is unreal. The remaining Chapters, *viz.*, infirmities, occupation, literacy, language, religion and caste are susceptible of fuller treatment according to the standard prescribed for the Provincial reports.

Section II.—Area, Population and Density.

37. Definition of Population.—The population dealt with in this report is that ascertained on the 26th of February 1931. Mention has already been made in the Introduction that a preliminary record of the population normally resident in each Census unit was prepared a month before the Census was taken. In a generally immobile population as in these parts there is little chance of any disturbance in the movement of the population. The preliminary records were corrected on the night of the Census, by striking out persons who were not present when the enumerator went round and by entering the names of the newcomers who were found in each house. To this had to be added the floating population in *serais*, *dharamshalas*, highways and people travelling in railway trains. 5 stations were selected for the enumeration of trains within the Agency limits.

The Census was not a synchronous one in all parts. In the hilly portions of the States of Ratlam, Ali-Rajpur, Barwani, Jhabua, Indore, Dhar and Rewa the Census was taken non-synchronously and suitable precautions were taken to prevent any movement from a synchronous to a non-synchronous area and *vice versa*. The tracts where there was a daylight Census are mostly inhabited by the primitive tribes and their population may almost be taken as *de jure* population. The non-synchronous tracts formed nearly 15 per cent. of the total area and their population constituted 11 per cent. of the total population. The date of the Census

Non-Synchronous Tracts.

State.	Estimated area in square miles.	Population.
1	2	3
Total	7,535·31	723,434
Ratlam	310·34	20,156
Ali-Rajpur	832·50	93,914
Barwani	1,035·67	99,774
Jhabua	1,181·00	121,235
Indore	226·07	27,497
Dhar	22·73	992
Rewa	3,927·00	361,866

was chosen so as to avoid any large disturbance in the movement of population. All over Central India weekly markets are held and many of these fell on the 26th of February. Some of them draw a large number of people as they are the chief distributing centres in those parts where communications are meagre. Through the co-operation of the States, all markets were stopped which fell on the Census day. Only few fairs could not be postponed. The most important of them is the fair at the temples of Khajuraho in Chhatarpur State. Fortunately the principal day of the fair fell after the Census date. The congregation was therefore small. The Khilchipur State held the *Garahet* cattle fair and two small fairs were held in Rewa. There is also considerable movement at the wheat cutting season but the Census was taken before the movement was in full swing in most parts.

Actual Population.—The population as disclosed on the night of the 26th February is the actual population. It is the population normally resident increased by those who happened to be caught in the Census net on that night less those who were away. It also included those who had arrived into the world at the time the records were checked, less those who had departed from it. This *de facto* or actual population is also more or less the normal population. In Imperial table III the number of travellers enumerated was only 8,239, *i.e.*, not more than 1 per mille of the total population. Considering this small exception, we may practically take the actual population as corresponding to the normal population. The tables in this report deal with the actual population.

Natural Population.—In some of the Subsidiary tables the term “natural population” will be found. It is meant to represent the population without the disturbing effects due to migration; that is, it represents the actual population *plus* those born in Central India but enumerated elsewhere *minus* those who are born elsewhere but censused in Central India. It is never possible to know all the persons who are born in the area dealt with but enumerated outside it. We get a fair approximation to that number which we use in arriving at the normal population.

38. Statistical reference.—The Imperial tables with which this chapter is mainly concerned are table No. 1 which gives statistics for area, houses and population, and table No. II which shows variation in population since 1901. The following Subsidiary tables will be found at the end of the Chapter.

- I.—Density, Water-supply and Crops.
- II.—Distribution of the Population classified according to Density.
- III.—Variation in relation to Density since 1881.
- IV.—Variation in Natural Population.
- VI.—Variation by Tahsils classified according to Density: (a) Actual figures; (b) Proportional figures.
- VII.—Persons per House and Houses per square mile.

39. Area.—The area of the Central India Agency shown in this report is 51,597 square miles.¹ Within this area, 63·79 square miles of territory are the British Administered Areas. The rest of the area comprises the territories administered by the rulers of the various States.

40. Population of Administrative units.—The real units of administration are the States and not the political agencies which as explained previously have been discarded in the present Census for the presentation of statistics. The

¹ The Survey Department has been unable to supply the most recent and correct figures of area and those supplied by it have mostly been compiled from surveys prior to 1905, modern survey being incomplete. The figures received from the Department are noted below and those which are based on old surveys have been marked (a)—

1. Baghelkhand Agency	14,570 (a)
2. Bundelkhand Agency	9,772 (a)
3. Indore Residency	9,862 (a)
4. Bhopal Agency	9,048 (a)
5. Southern States Agency	5,491 (a)
6. Malwa Agency	2,599 (a)
7. Manpur (British)	54

This total area is less by 133 square miles than the area shown in the report (excluding Khaniadhana). In the absence of the detailed figures by States it would be misleading to use the figures for political charges which are changing from Census to Census.

diagram opposite shows the actual population of the principal States in Central India and the other exhibits clearly the actual population of the principal States

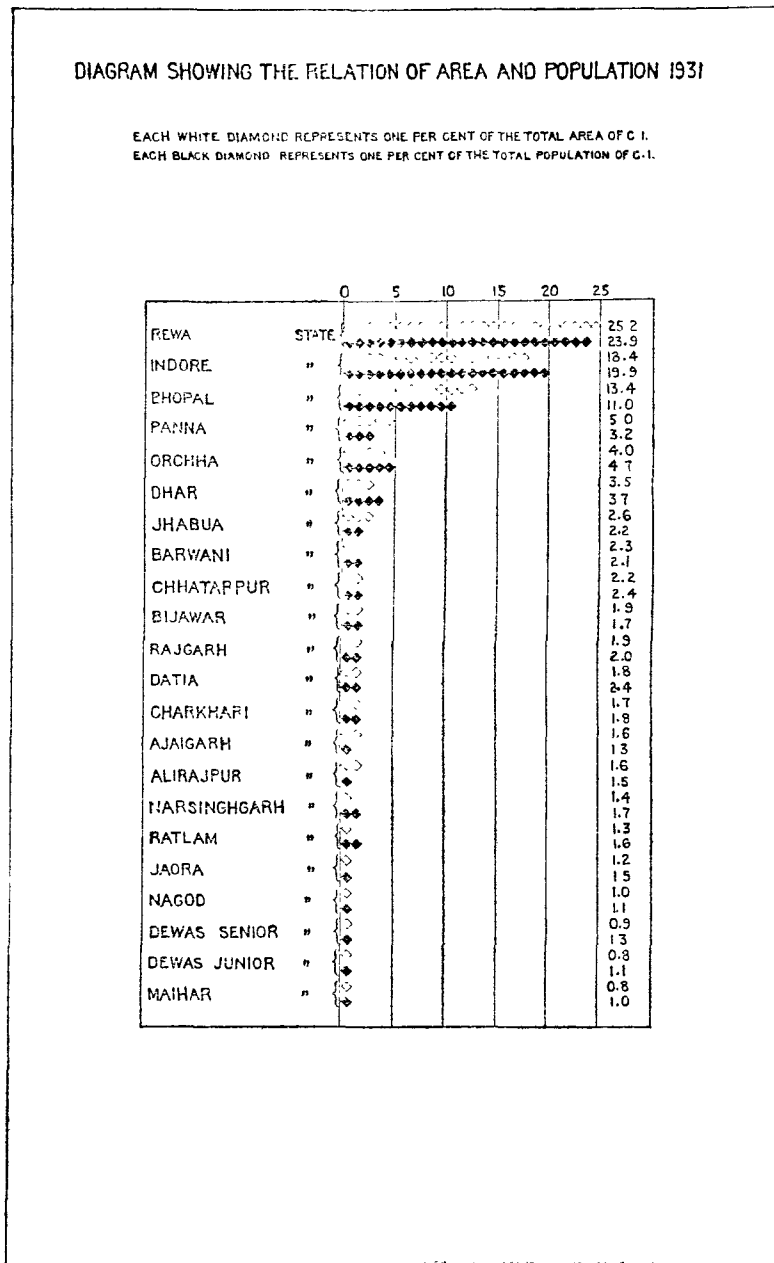

arranged in order of population. The marginal diagram showing the relation of area and population is meant to illustrate the distribution of the total area and population over the principal units. The three big States—Indore, Bhopal and Rewa—occupy 57 per cent. of the total area and account for 55 per cent. of the total population. Of the remaining States, only 2 States are of over 2,000 square miles but less than 3,500 square miles. 4 States have an area between 1,000 and 2,000 square miles. The number of States having an area between 500 and 1,000 square miles and between 100 and 500 square miles is 10 and 13 respectively. At the extreme end there is Banka-Pahari with an area of only 5 square miles. Similarly with regard to population 2 States have a population

of over a million and one State over half a million. Three States have population between 2 hundred thousand and 5 hundred thousand. As many as eleven States have population between one hundred thousand and two hundred thousand and the population of five States ranges from fifty thousand to one hundred thousand. Kamta-Rajaula has a population of 1,114. These figures bring home the enormous diversity of the Central Indian States from the point of area and population.

The average State in Central India with a small area and sparse population stands no comparison with the British districts in the thickly populated parts of the Gangetic plain. Thus the district of Mymensingh in Bengal contains over 77 per cent. of the total population of Central India which is again far less than the divisional population of Gorakhpur in the United Provinces or Chota Nagpur in Bihar and Orissa. Nearer home, if we take the three large States, Bhopal is comparable in population to an average district in the Central Provinces while the largest State in the Rajputana Agency far outstrips the population of Rewa or Indore.

Average population of a district in the Central Provinces and Berar.	704,895
Population of Bhopal	729,955
State (Jaipur) with largest population in Rajputana.	2,636,775
Rewa	1,587,445
Indore	1,318,237

in Bihar and Orissa. Nearer home, if we take the three large States, Bhopal is comparable in population to an average district in the Central Provinces while the largest State in the Rajputana Agency far outstrips the population of Rewa or Indore.

DIAGRAM SHOWING THE ACTUAL POPULATION
OF THE PRINCIPAL STATES OF THE AGENCY
IN 1931

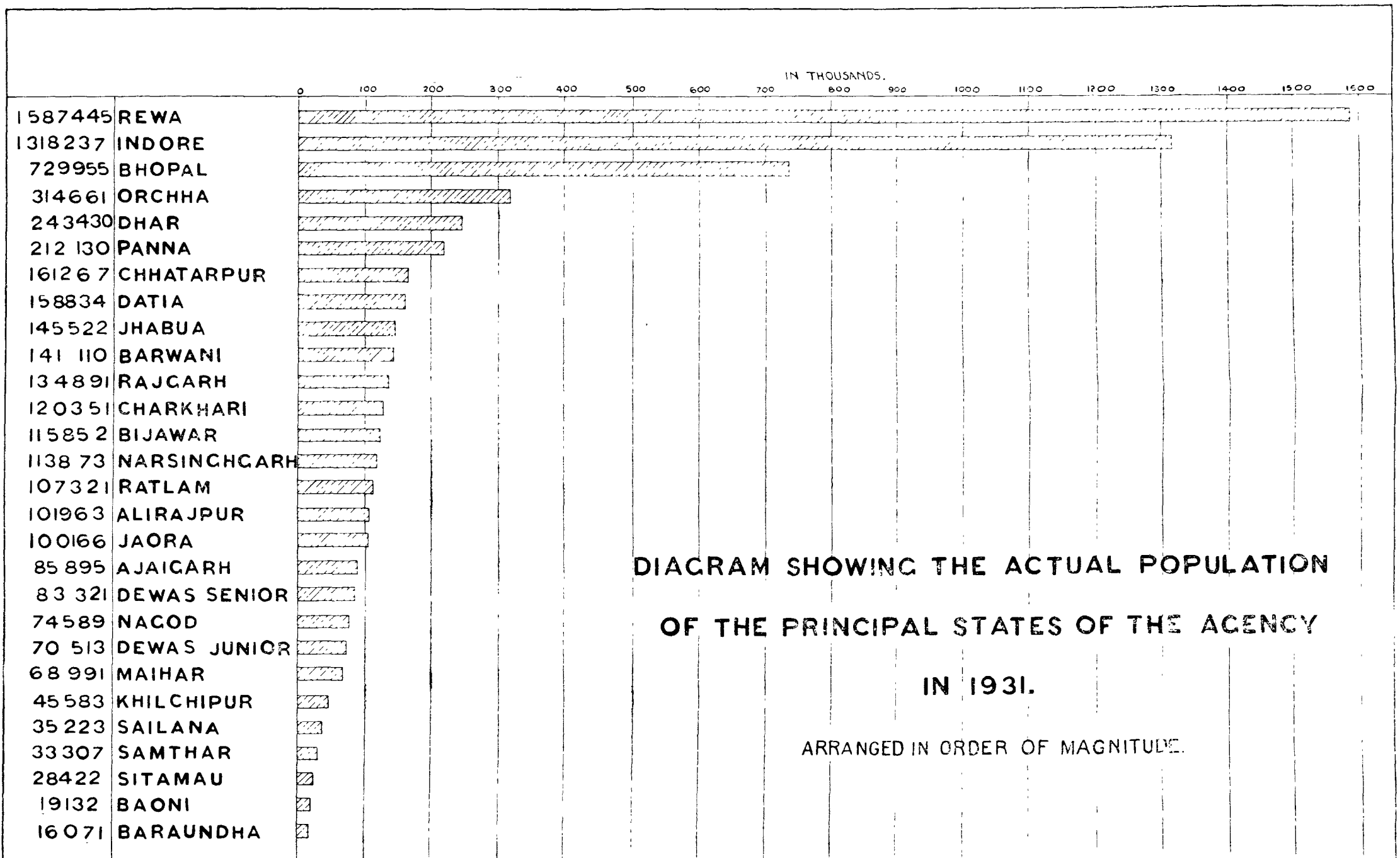
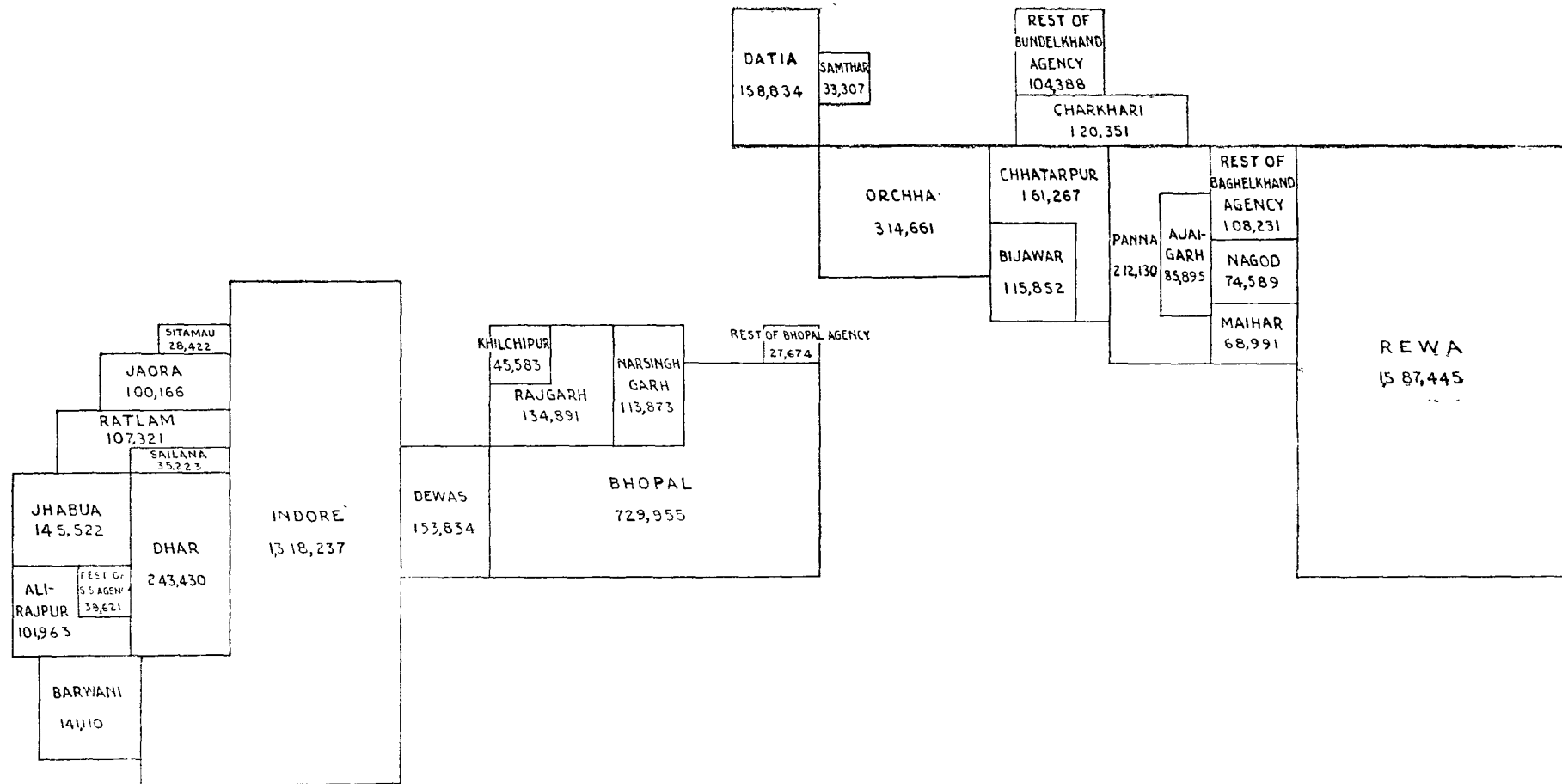

41. **Density.**—The density of Central India Agency is 129. This is what is called the mean density and is obtained by dividing the population by the total area. This figure is not uniform everywhere but varies in different parts. These variations by different States are shown in the map. Broadly speaking (except

CENTRAL INDIA AGENCY
SHOWING
DENSITY OF THE POPULATION
BY STATES 1931.

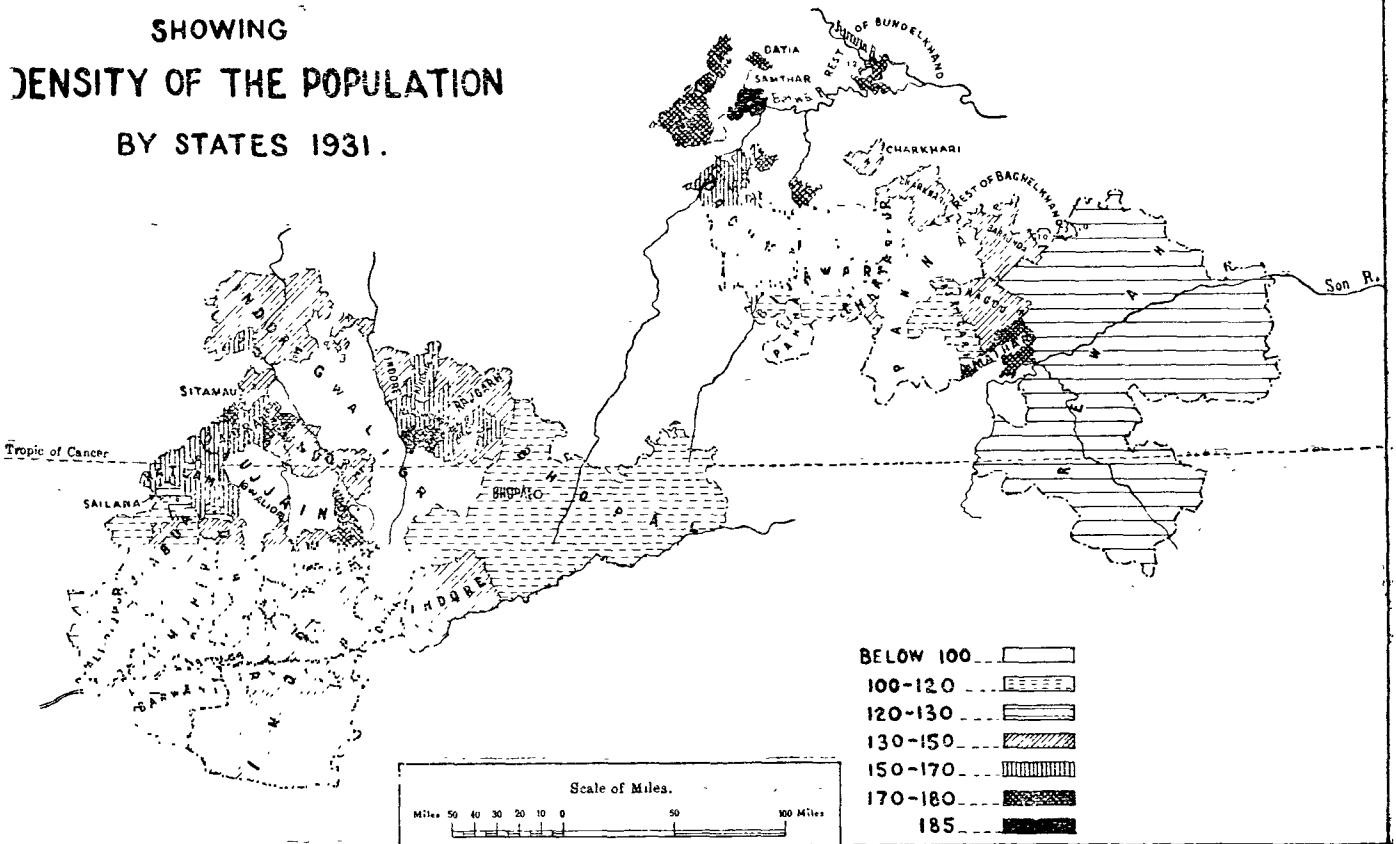

tions to this can easily be recalled), States having a density below 140 are those which are entirely situated on the Vindhyan ranges or those whose part territories lie on the Vindhyas. Most of those whose density is over 140 lie mainly on the plateau or on the low-lying parts of the East. In Subsidiary table II at the end of the chapter will be found the distribution of the population classified according to density. It will be seen that only 2 classes—under 150 and 150-300—are sufficient to cover our units. 82 per cent. of the total population is accommodated in the first category and only 18 per cent. in the second one. We also see that in no State is the population distributed over these two classes. All the units in this table having a density of more than 150 but less than 300, are those which mostly lie in parts where the Central Indian hills have not badly broken the configuration of their surface.

The mean density figures are by themselves not very informing. A small strip of ribbon-like area, such as, say, the Nerbada valley, may support a large population while the hills near about clad with forests may remain empty. In order that we may obtain a better idea as to density we must enquire more closely into the density of smaller units such as *Tahsils* or *Parganas* and correlate the density of each part with the cultivable area and rainfall, with the proportion of gross cultivated area and such other factors. The figures shown in Subsidiary table I are intended for such an enquiry. In Provincial table I, the density of population has been worked out for the smallest administrative division of each State. Though some sort of figures are there, I shall briefly explain why they are of no value for accurate statistical analysis. The recorded area in many places is untrustworthy. Even the areas as recorded in the previous Census reports and carried over from Census to Census are based on old Survey records and they have not been brought

up to date. In many States there has yet been no systematic survey and settlement on modern lines and the figures are based on approximation. As regards the agricultural statistics the position is again far from satisfactory. The diversity of the many units makes it impossible to know on what system the statistics are maintained. Each State has its own system and even the land-tenure changes from place to place. The majority of the units being small States, they cannot afford to have a costly land revenue establishment and the administrative system is of different grades. Further in each State there are alienated holdings, such as *jagir*, *inam* or *istimurar*, about which the State revenue department possesses no reliable statistics. The Central India Agency not being an administrative unit there is no arrangement by which the agricultural and other statistics could be co-ordinated and published for the Agency as a whole. Again with the exception of one or two States, the others possess no settlement reports and even if they do, are reluctant to bring them out. So very little reliance can be placed on the figures exhibited in Subsidiary Table I which have been compiled from different sources. The most reliable of them in few units do not cover the whole area of the State. The majority are of doubtful reliance and a few at least are very crude estimates. Thus, in one place the only information available is the number of ploughs and a plough's capacity to cultivate is taken as about 12·5 acres and the area actually cultivated in 1931 has been arrived at by this means.

Under such circumstances, I do not propose to consider what lies behind the crowding of people in any area, or otherwise discuss the factors of density in detail or embark upon the wider economic problems arising out of them. Few general points may be mentioned by way of suggestion rather than to establish any definite correlation. The physical features of Central India are well-known. The gentle undulating plateau of Malwa or the low-lying eastern tracts are broken up by the Vindhyan series, the Kaimur range and the Panna hills. Where there are large and continuous strips of cultivable land, they have been parcelled out in an endless manner by the different States and their feudatories and *jagir*-holders. The inconveniences arising out of the fragmentation of agricultural holdings are often discussed. The fragmentation of sovereignties have their own problems. Density in Central India is thus affected by the presence of inhospitable regions where man cannot crowd and by local restrictive conditions that to some extent hamper the growth in those parts where the soil can support more people. The soil of Malwa is rich and in the past it has been a proverbially favoured region. Historical and administrative causes have played a considerable part in influencing the density of Central India. Early in the 19th century the country passed through an intense period of anarchy. The depopulation of a country which already had a thin population had gone to such an extent, that the historical events have left marks of permanent and deep-seated injury. In the backward tracts the recovery was slow, perhaps too slow, and just when the country was regaining prosperity, the heavy blow of famine fell on Central India in 1901, gravely retarding the growth of prosperity. Again, given the necessary physical factors, such as soil, rainfall and sufficient supply of water, man may not crowd as much as the presence of these factors would justify on account of administrative restrictions and policy. Both in the plateau and in the low-lying eastern parts agricultural conditions must be held to influence density. The soil in many parts can easily support a greater population than it does at present. It seems necessary that the sources of available water supply must be increased. The undulating nature of the plateau does not lend itself to extensive canal or tank irrigation and the area commanded is restricted. Besides tank irrigation the extension of well irrigation is a matter of primary importance everywhere. In the increase of the available water supply by well irrigation, the State can give help and eliminate artificial administrative checks. When concessions on wells are given to a tenant to reimburse him for the capital he has expended, the well practically becomes a State property and the tenant's only right in the well is a right of transfer. The writer of a settlement report concerning one of the Central India States, from whom I have quoted proceeds to make the just remark that in taxing the improvements made by tenants, it is perhaps well to remember that ploughing and sowing land is as much an improvement as irrigating it and that if the strictly equitable view be adhered to the State is only entitled to the rental which the land would produce under grass. With no immediate prospect of industrial development and urbanization, with meagre communication in different parts, and with inelastic and even

diminishing revenues and increasing expenditure in administrations, the States will have to consider in coming years the economic problems arising out of the distribution of population in their territories.

Section III.—Movement of the Population.

42. **Variation in Population in previous Censuses.**—The present Census is the sixth decennial Census for this Agency. There is no authentic information about any previous enumeration in these parts before the British paramountcy was imposed. It appears that Census was taken in very early times and the Mauryan bureaucrat was allowed to ask all kinds of questions which are forbidden by the Indian Census Act. Espionage was linked up with Census and this perhaps made the task of the Mauryan Census Superintendent a more interesting pastime than that of his present day successor who has to battle with statistics! The first recorded enumeration of Malwa was made by Sir John Malcolm in 1820. It was only a partial estimate in certain portions of Malwa. At that time Bundelkhand and Baghelkhand did not form a part of the Central India Agency. The first regular Census was taken in Central India in 1881. The schedule used was a modified one and it did not contain all the details that were prescribed in the British Indian Schedule. The primitive tribes were not enumerated: only a rough estimate was made on the information obtained from the headmen of the tribes. No superintendence was exercised by the Imperial Government and the work was far from accurate. In fact the author of the note on the Census of 1881 says that it is not safe to regard the figures otherwise than as *rough* estimates of the people and the facts connected with their existence. Sir Lepel Griffin who was then the Agent to the Governor General in Central India wrote that the Census returns of Central India were, for comparative and deductive purposes, not worth the paper on which they were written. In 1891 the procedure in no way differed from the previous one but the writer claimed greater accuracy in enumeration. Still many of the States must have been very backward 40 years ago and it does not appear there could have been a really marked improvement. It is from 1901 that the Census of this Agency was carried out systematically as in British India and the operations were conducted with the same minuteness and care as in other parts. Owing to the destruction of the registers in the 1881 Census and the absence of the *Pargana* figures in 1891, it will be seen from Imperial Table II that the adjusted population for the Agency prior to 1901 is not available. No great reliance can be placed on the figures where available, for the Censuses before 1901. The movement of population for the Agency is therefore best considered from 1901.

Throughout the first three quarters of the 19th century conditions were not favourable for the rapid growth of population in Central India. In the first quarter of the century the once smiling land of Malwa had become a desert and the eastern parts were equally disturbed by internecine feuds and disturbances. The extent to which the population of Malwa for which alone we have statistics, suffered in the period of anarchy can be gauged from the table printed as Appendix XV to the *Memoir*. In Indore State, for example, out of 3,701 *Khalsa* or Government villages only 2,038 were inhabited; 1,683 were in extreme state of desolation. Out of 2,596 *Khalsa* villages in Bhopal, 965 alone were inhabited. Shortly after, in 1829-30 and in 1833-34, Bundelkhand was visited with a very severe famine. With the establishment of peace throughout Central India the rulers of the States tired and exhausted, fell, so to say, in slumber. The effect was psychological in the case of the larger States, with their ambitions curbed, their activities restricted, their sphere of influence diminished and their authority attenuated. The disinherited many tenaciously clung to what little was restored to them out of the wreckage. When the excitement due to the Mutiny subsided, a new spirit began to stir some of the big States but the back waters were rarely disturbed even by a ripple. But towards the end of the century with the opening up of communications and the penetration of the ideas of progress in many parts, the population also showed signs of increase. Unfortunately this progress was arrested by the visitation of severe famine towards the closing years of the century. Ill-prepared and ill-equipped to meet it, the machinery in the States broke down and the resulting loss of life was terrible.

In 1901, the opening balance of the Agency population, after the adverse effects of the heavy famine mortality, stood at 5,435,038. In the decade that

followed there was an effective rebound. It has been shown in previous Census

Population and Density 1901-1931.

Year.	Population.	Density.
1901	5,435,088	105
1911	6,133,764	119
1921	6,002,551	116
1931	6,632,790	129

This is clearly seen in the increase in the population between 1901 and 1911 when the population increased by 12·8 per cent. The increase would have been more but for the visitations of several virulent plague epidemics which affected the urban areas. In the next decade there was again a set back

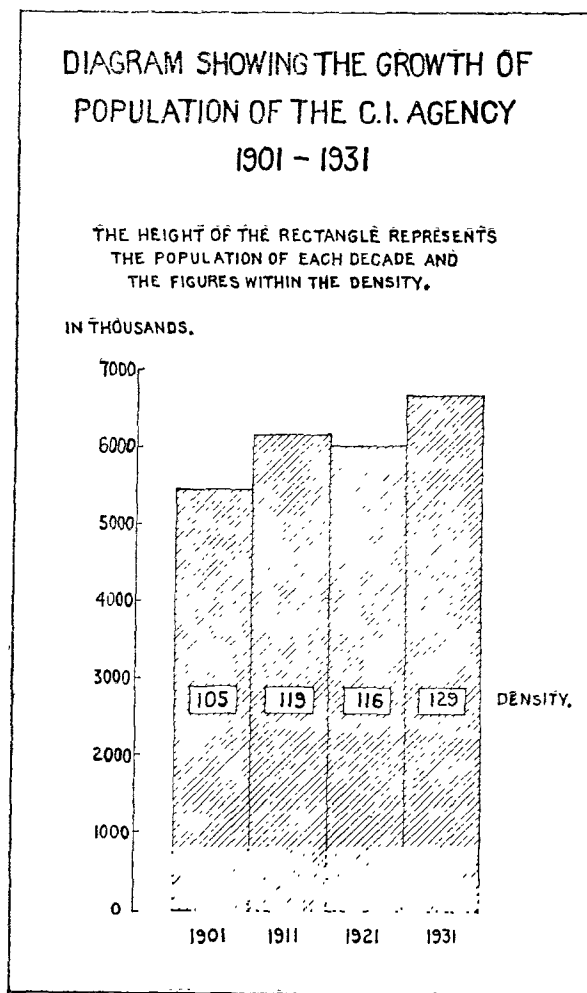

reports that famine affects people at the two extremes of life—the very old and the very young. The reproductive power of the people who escape the selective mortality in famine comes into play. The birth-rate increases and death-rate is low. There is therefore a large growth in population.

due to the Influenza epidemic.

A rough estimate given in the last report for the Agency showed that the mortality due to Influenza was well over 4 and 5 hundred thousand. It was perhaps much more than that. The population fell in 1921 by 2·1 per cent. This fall was uneven. The West showed an increase of 4·2 per cent. while the East recorded a fall of 8·1 per cent. The backward areas in the East were very severely affected by the epidemic. We have no definite figures to guide us. In the present decade which we may call a normal one, the population has increased by 10·5 per cent. This corresponds exactly to the rise in the population for the whole of India. The marginal diagram and the graphs on the opposite page illustrate the movement of the population in the previous decades.

43. Variation in Population since 1921.—In the last 10 years the population of the Agency has increased by 630,239 or by 10·5 per cent. The increase is

not the same in both the Divisions. The West is more progressively increasing than the East. The two tracts are approximately equal in area, population and density. The increase in population can only be due to two causes : excess of births over

Variation since 1901.

Agency and Natural Division.	Area.	Popula-tion.	Den-sity.	VARIATION PER CENT. IN		
				1921-31.	1911-21.	1901-11.
1	2	3	4	5	6	7
CENTRAL INDIA						
AGENCY	51,597	6,632,790	129	+10·5	-2·1	+12·8
West	26,742	3,486,849	130	+12·2	+4·2	+15·9
East	24,855	3,145,941	127	+8·7	-8·1	+10·1

deaths and migration. As there are no registered vital statistics, we cannot compare the increase shown by the Census with the excess of registered births

PROPORTIONATE CHANGES IN THE POPULATION OF SOME OF THE PRINCIPAL STATES IN C.I. AGENCY 1881 - 1931 AS SHOWN BY THE CURVES OF THE LOGS OF THE POPULATION.

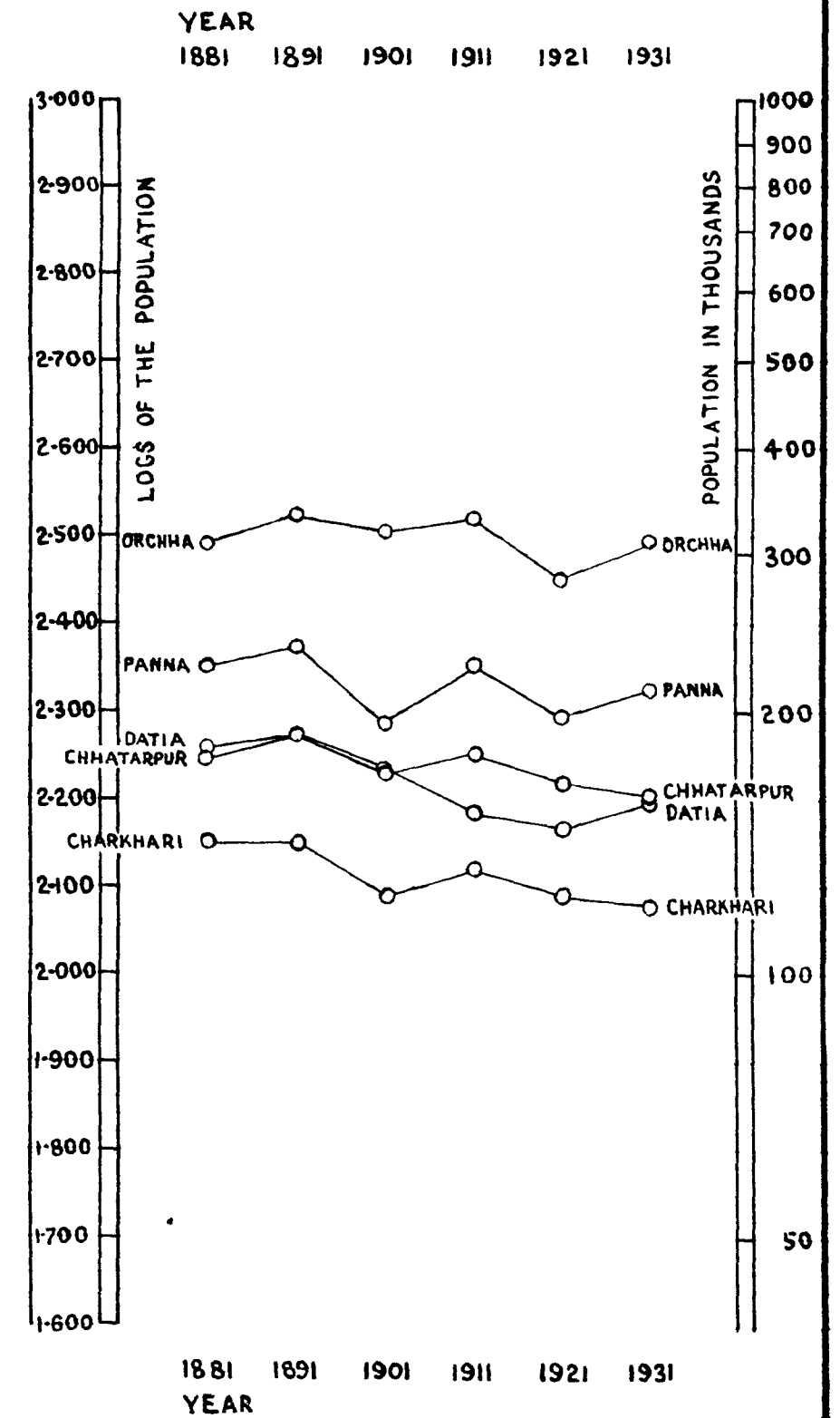
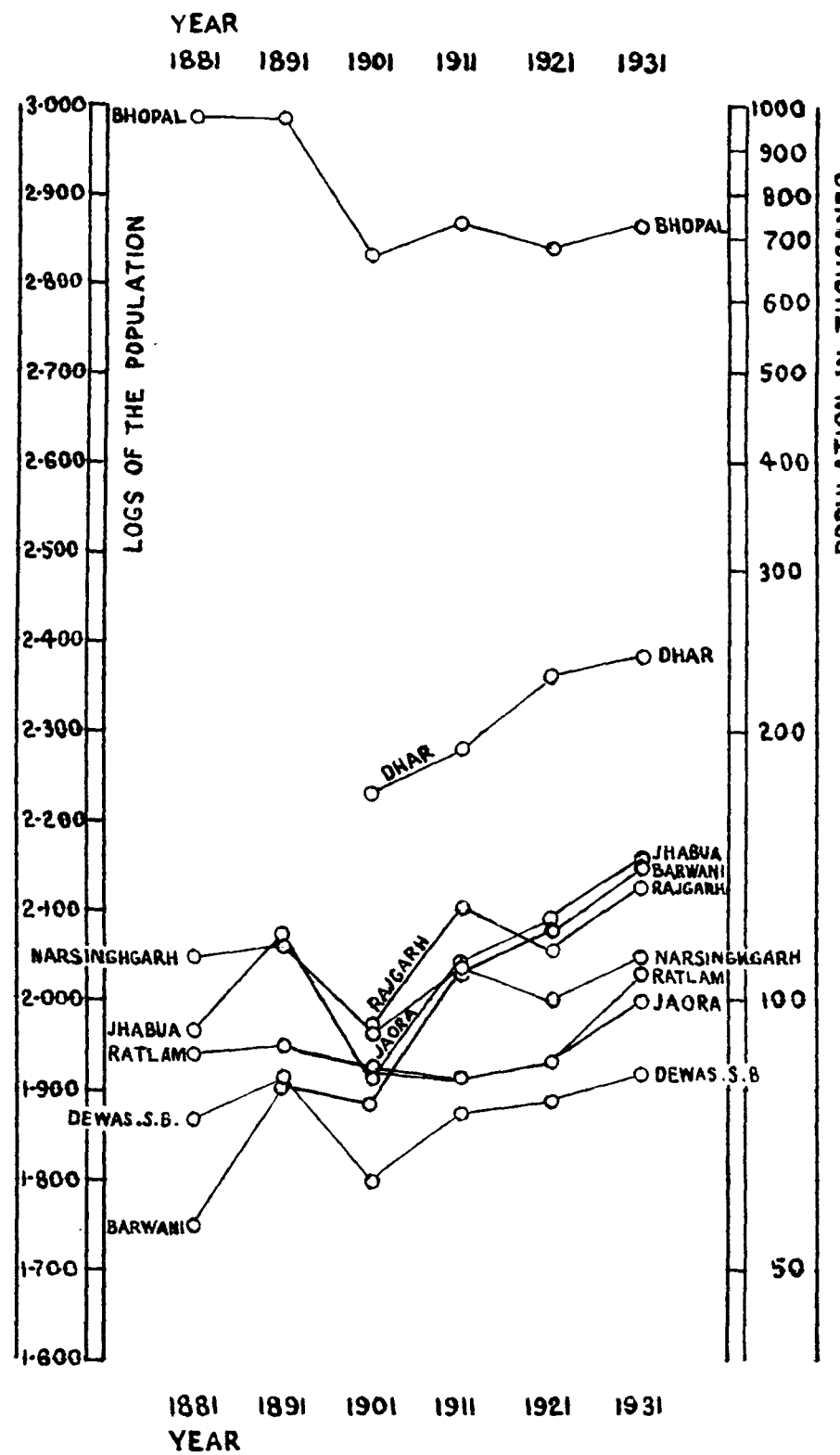
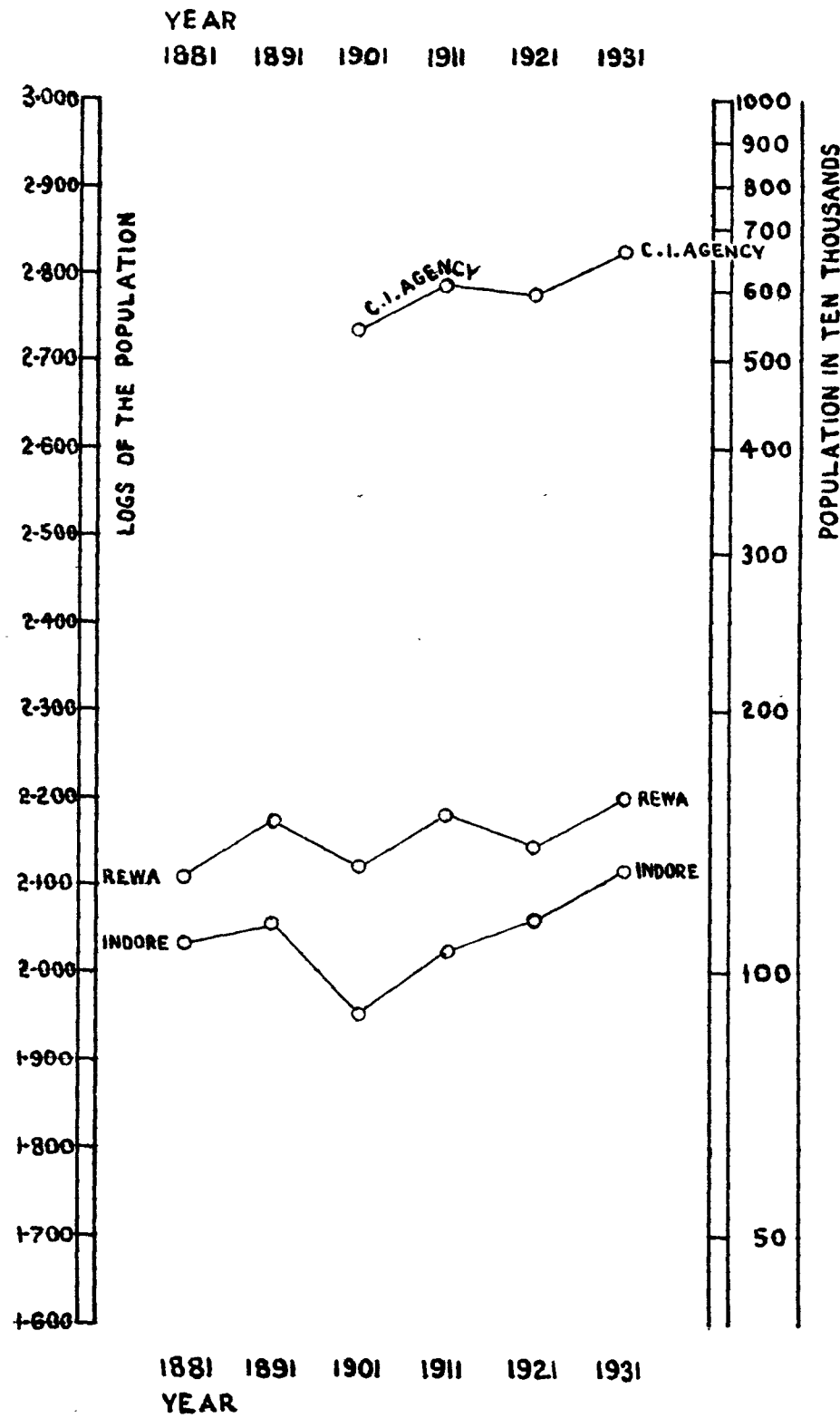

CENTRAL INDIA AGENCY
 SHOWING
VARIATION IN POPULATION
 BETWEEN 1921 & 1931.

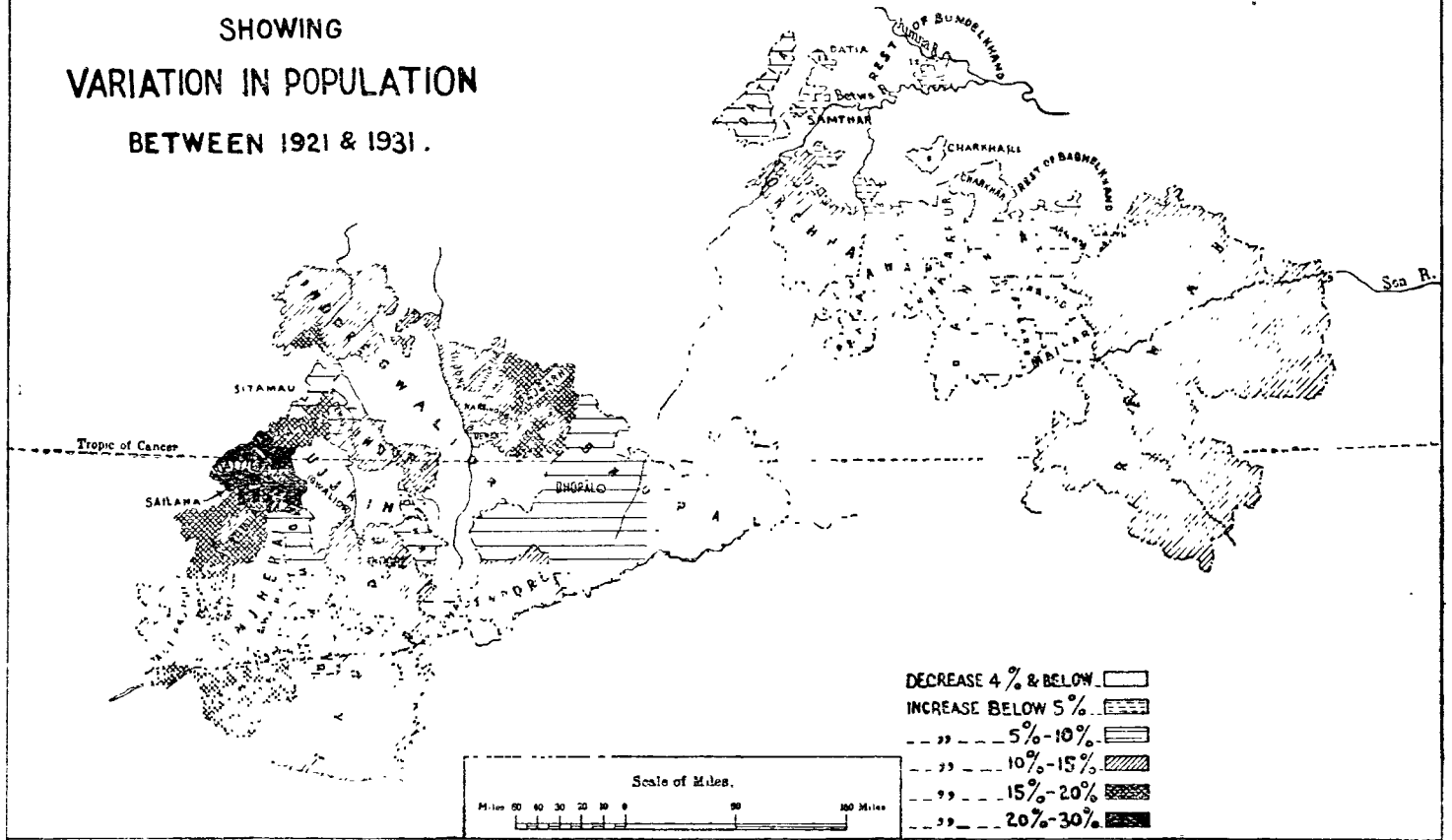

CENTRAL INDIA AGENCY
 SHOWING
VARIATION IN DENSITY OF THE POPULATION
 BETWEEN 1921 & 1931

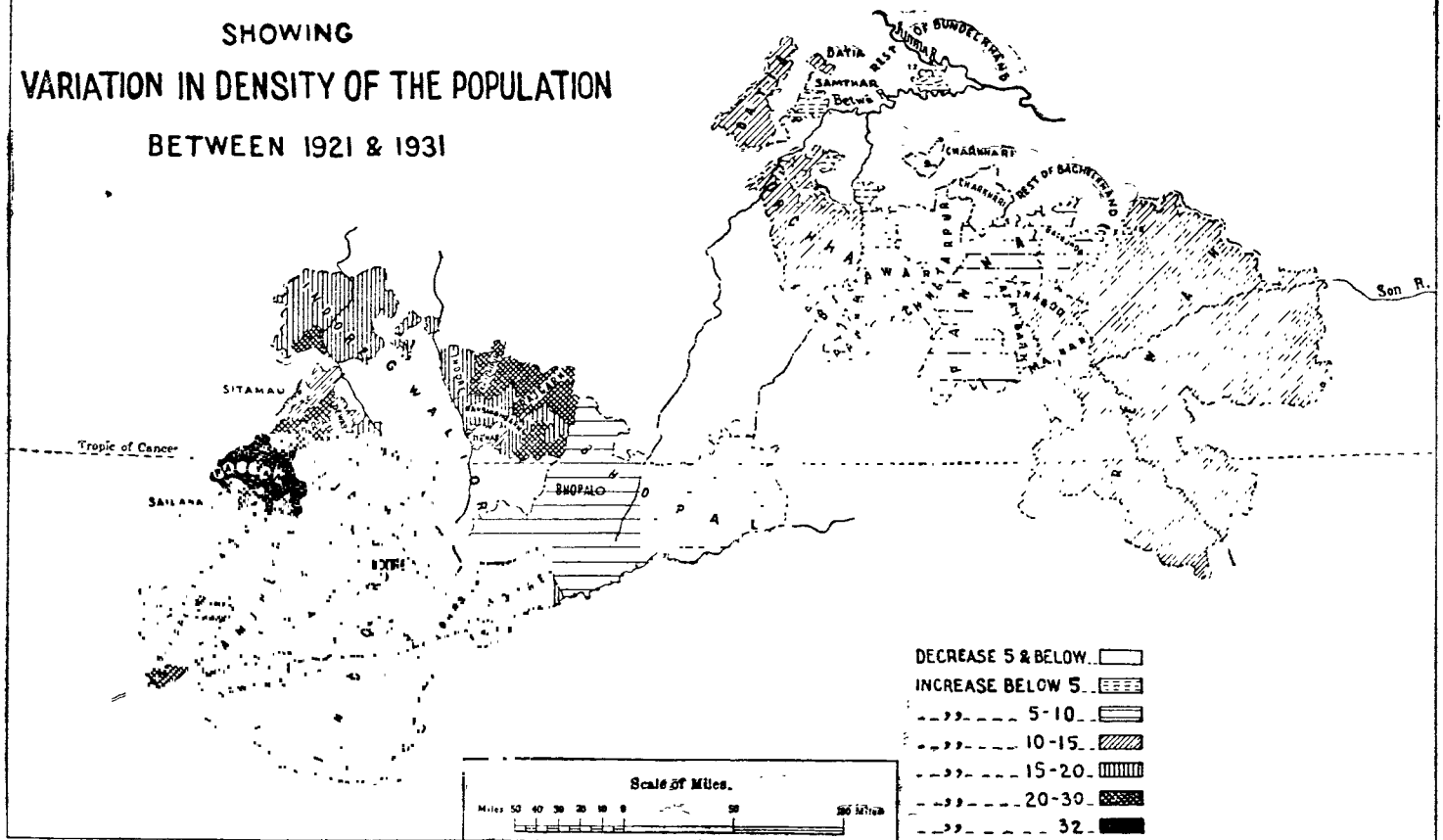

over deaths. Some idea as to the growth of the population can however be

Increase due to Migration and Natural Growth.

Agency.	Gain (+) or loss (-) by migration in 1921-31.	Variation of natural population.	Total increase, 1921-31.	PERCENTAGE OF TOTAL INCREASE DUE TO	
				Migra-tion.	Natural Growth.
1	2	3	4	5	6
Central India . . .	+52,768	+582,999	630,239	8.4	91.6

obtained from the marginal table. As the natural population figures are not available for the natural divisions, only those for the Agency as a whole have been shown. Thus the natural growth accounts for over 90 per cent. of the increase.

Migration as a factor does not intrude itself in accounting for the growth of

Variation in Actual and Natural Population.

Population.	1931.	1921.	Variation per cent.
1	2	3	4
Actual Population . . .	6,632,790	6,022,551	+10.5
Immigrants	598,102	548,094	..
Emigrants	482,294	485,054	..
Natural Population . . .	6,516,982	5,933,983	+9.8

population. This is apparent from the marginal table. The actual population has increased by 10.5 per cent. while the natural population has increased by nearly the same amount. The difference is only .7 per cent. In the absence of other data, we are merely able to obtain just a glimpse as to how the population has increased in the decade.

Two maps and a diagram are given to illustrate the variation in population during the decade. One map and the diagram show the increase or decrease by

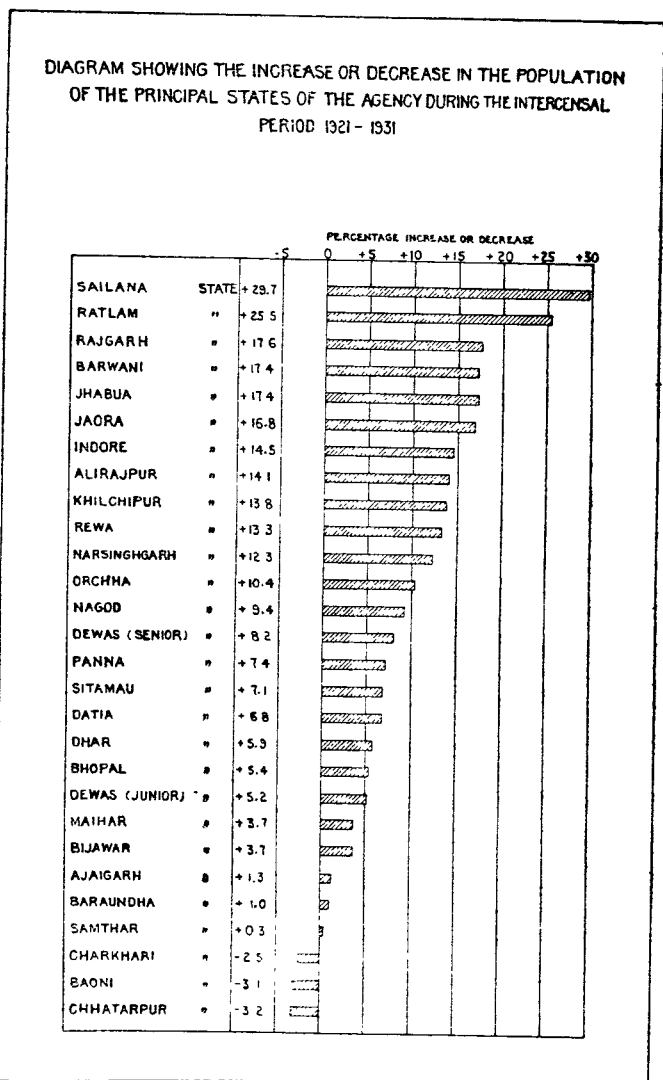

States as a percentage on the population in 1921 and the other as a variation in density. It will be noticed therefrom that in the West the increase is highest in Ratlam and Sailana, followed by Jaora and is least in the Dewas States and Sitamau. These States are all in the Malwa Agency. In the Bhopal Agency, the three small States of Khilchipur, Rajgarh and Narsingharh show an increase well over the provincial average while Bhopal has only increased by 5.4 per cent. The same rise is shared by Dhar while the rest of the States in the Southern Agency show higher increase. The rise in Indore is 14.5 per cent. None of the States in the West show a decrease and with the exception of Bhopal, Dhar, Dewas States and Sitamau, the rest have increased over 10 per cent. The same cannot be said of the East. Only Orchha and Rewa keep pace with the provincial rise. Charkhari, Chhatarpur and

Baoni actually show a decrease. On the whole the eastern parts are recovering much more slowly than the western States.

44. Economic Condition of the Decade.—In the introductory remarks at the commencement of this chapter, a brief summary of the economic conditions of the Agency has already been given. With the scanty and incomplete material supplied by many States, it is not possible to reconstruct out of it a lengthy and detailed account of the condition of the decade. A brief summary sufficient to form a background to appreciate the movement of the population in the intercensal period is all that is set out in this paragraph. The decade 1921-30 may be safely set down as one of comparative prosperity. There was no actual famine or serious scarcity in any large area and the decade was practically free from any widespread epidemic of a virulent type. The supply of food and fodder was generally sufficient. The prices were fluctuating according to production but generally continued to prevail high until about the close of the decade when they fell down considerably in consequence of the universal and world-wide economic depression. The wages have remained practically stationary. The economic conditions on the whole were favourable to the growth of population, there being no serious disturbing factor.

Crop and Rainfall.—The country is predominantly agricultural and the prosperity of the people depends on favourable agricultural conditions. Except in few parts of Bundelkhand where irrigation from the Betwa, Dhasan and Ken canals is available to a limited extent, the chief sources of irrigation are wells, *bandhs* and tanks. The success of crops therefore largely depends on proper supply

Average Rainfall in inches.

Year.	Central India.	West.	East.
1	2	3	4
1921 . .	32.95	30.67	35.24
1922 . .	40.59	35.98	45.19
1923 . .	40.43	36.99	43.88
1924 . .	43.48	38.99	47.96
1925 . .	34.84	23.32	46.36
1926 . .	45.09	33.89	56.29
1927 . .	38.27	34.95	41.59
1928 . .	31.00	32.03	29.98
1929 . .	29.03	29.01	29.06
1930 . .	39.63	37.39	41.87

of rain water. The mean average rainfall during the decade for the Agency and the two Natural Divisions is noted in the margin. In the years 1921, 1928 and 1929 the rainfall in the Agency as a whole and in the East was below the average while the years of deficient rain for the West were 1925 and 1929. There was an excess of rainfall in 1924 and 1926 in the East and in 1924 and 1930 in the West. During the latter part of the decade the crops suffered off and on from rust, frost and hailstorm and from the visitation of locusts in various parts of the Agency, but the extent of damage was not considerable in any part

and it was localised in few areas. Wherever necessary, suitable relief measures such as the grant of remissions of revenue and *Taccavi* advances by the States concerned eased the situation and helped the cultivators to tide over the difficulty. On the whole, the condition of crops was fairly satisfactory all over the Agency except in the Bhopal political agency where the crops are reported to have suffered somewhat seriously. Parts of Bhopal State lying on the bank of the Narbada also suffered from the inundations of the river in 1923 and 1926, the damage in the latter year being considerable. The economic condition in the principal units of the Agency is discussed in the next Section in connection with the variation in population. Survey and Settlement operations were in progress during the decade in Ajaigarh, Bijawar, Charkhari, Orchha and Maihar in addition to the States mentioned in the next Section and a revision and re-assessment of rates was undertaken in Baoni and Datia.

Public Health.—No vital statistics are available and the figures of reported deaths from epidemics are very unreliable. They are sufficient only to indicate that the decade enjoyed practical immunity from all epidemics of a virulent type and that the loss of life from these was not accountable as an important factor in the variation of population. In 1921 few cases of Plague occurred in Bhopal State while in the years 1921-22, 1924 and 1930 the Eastern States of Rewa, Maihar, Panna, Chhatarpur and Bijawar were affected, but the loss of life was inconsiderable. In the years 1921 and 1928-30 Cholera seems to have appeared in an epidemic form and was reported from most of the States, Bhopal Agency and few Eastern States being comparatively more affected. The loss of life was however not great. Cases of Influenza occurred in the British Pargana of Manpur in every year. The place is malarious after the rains and exposure is likely to develop into pneumonia or influenza. In other places there were only occasional cases. In 1930, Small-pox prevailed more or less in most States, those chiefly affected being Indore, Bhopal,

Rajgarh, Narsingharh, Dewas, Ratlam, Barwani and Dhar in the West, and Char-khari and Maihar in the East. In the remaining years of the decade except in 1926 when a few of the eastern States were also affected, the disease was practically confined to some States in the West, Indore being subjected to its unwelcome visitations to a larger extent.

Section IV.—Variation by Principal States.

45. **Indore.**—The State of Indore is formed of several detached tracts. The largest and the most compact lies south of the Vindhya. One portion of the State lies on the Malwa plateau and included in it are the districts of Indore, Mahidpur and Rampura-Bhanpura. The other section, comprising the districts of Nimar and Nemawar lies partly on and below the Vindhyan hills and the district of Nimar includes in it a portion of the Satpuras as well. Besides these two broad divisions there are two detached *Parganas* lying far away from the main block of territory. One is the *Pargana* of Alampur with an area of 37 square miles. It lies wholly on the alluvial plain of the Jumna-Ganges doab, in a flat country of moderately fertile soil. The other is the *Pargana* of Nandwai situated in the Rajputana Agency. It is a hilly area. The soil is rocky and of low fertility unsuited for *Rabi* crops. Of the total area of the State, 4,582 square miles are situated on the plateau. The seasonal and economic conditions throughout the decade were normal and satisfactory. In the opening year of the decade rainfall was not up to the average especially in Nimar, Nemawar and Rampura districts. These suffered from scarcity of foodstuffs and fodder. In the next three years, except in 1923 when the distribution was uneven, the rainfall was good, and the crops were satisfactory. In 1925, rainfall was below normal. *Kharif* suffered in places but *Rabi* was better. In the next two years rainfall was late. *Kharif* suffered in places. In 1928 and 1929, rainfall was unevenly distributed. In 1930 rainfall was in excess and the crops were good everywhere. The State is favourably situated and is undergoing a process of expansion for some decades. The capital town lies in the very heart of Malwa and its remarkable rise has contributed a great deal to the growing prosperity of the State. Excellent road communications have opened up the different scattered parts of the State. 66 miles of metalled road were constructed during the decade and the total mileage of roads is now 780. The textile industry has developed considerably. Besides 7 mills in Indore City, there are 105 ginning factories and 25 cotton presses in the State. In 1930, 13 Joint Stock Companies with an authorized capital of Rs. 3,647,500 were in existence. The State has been resettled and rural development and expansion

Population, Density and Variation—Indore.

Indore.	Popula- tion in 1931.	Density.	VARIATION PER CENT.	
			1921-1931.	1911-1921.
1	2	3	4	5
State Total	1,318,237	138	+14.5	+9.4
Indore District	386,350	245	+12.9	+25.4
Mahidpur District	143,936	162	+11.7	-6.9
Rampura-Bhan- pura District.	223,716	105	+10.4	+5.2
Nemawar District	99,972	94	+16.3	-9.7
Nimar District	464,263	120	+18.6	+11.0

are receiving attention. But for the serious inroads of the 1901 famine, the population of Indore State has steadily expanded and compared with the 1891 figures, the population now shows an increase of 13 per cent. A greater part of Indore district lies on the plateau excepting the southern portion of Mhow *Pargana* abutting on the Vindhya which also traverses the detached and isolated *Pargana* of Petlawad, mostly inhabited by the Bhils. This *Pargana* shows the highest increase in this district. Slightly less than one half of the population of the district is concentrated in the city of Indore and the adjacent Cantonment of Mhow. Except in the portions covered by the jungle the district is highly cultivated and grows excellent crops. The decrease in Indore and Depalpur *Parganas* is somewhat unexpected. Barring few areas which are broken up by low hills, the whole of Mahidpur district is an open, undulating plain and shares the characteristics of the plateau. The soil is rich black loam, and even though the eastern portions are broken up by low hills covered with scrub jungles, the soil in the valleys which is renewed by the denudation of the hills, affords rich fields and pasture grounds. Owing to drought and scarcity the detached *Pargana* of Alampur has decreased in population, and like the small sized towns Mahidpur is not prospering. The southern sections of Rampura-Bhanpura district lie on the plateau but north of

Rampura the hilly tracts, an arm of the Vindhya, have spread from east to west, and they form a part of the range which has spread from Chittor to Chanderi. Their extension into the district has affected its homogeneity. The tract was once an opium-growing area. The contraction of the area under poppy and the scars left by the famine of 1899 are perhaps retarding the full growth of this district. Only the Garoth *Pargana* shows an increase of over ten per cent. Nemawar district falls into two sections. The north-west and southern portions are hilly and covered with forests. The central and eastern portions are covered with fertile alluvial soil and bear good crops. In all the three *Parganas* the population shows considerable increase. The district of Nimar is a compact block of territory but is extremely varied. It is encased between the Vindhya and the Satpuras and the Narbada flows in between them. The land is fertile on the adjacent sides of the river with belts of rich alluvial soil. There are stretches of barren plains and low rocky jungles, while the forest areas are covered with wild jungles. The lowest density is in Sendhwa *Pargana* which lies on the Satpura ranges. Nimar district shows the highest increase of population in the whole State.

46. Bhopal Agency.—The Bhopal political charge under a Political Agent consists of the States and Estates of Bhopal, Narsingharh, Rajgarh, Khilchipur, Kurwai, Muhammadgarh and Pathari. Basoda is being treated for political purposes as a separate unit in this charge pending the decision of its status *vis-a-vis* Gwalior but its statistics are included in those of Gwalior. The area of the Agency is 9,073 square miles and the population has increased by 7.9 per cent. The average density is 116. The Agency lies on the plateau of northern and eastern Malwa. The Agra-Bombay road and the Ujjain-Bhopal and the Itarsi-Jhansi sections of the G. I. P. Railway traverse the charge. The Political Agent stays at Bhopal.

Bhopal.—A greater portion of Bhopal State is situated on the Malwa plateau the south-east portion of which is traversed by off-shoots of the Vindhyan hills. The main line of the Vindhya lies to the south and beyond the hills is the fertile valley of the Narbada. The plateau land is highly fertile and patches of fertile soil are found at the foot of the hills and beyond in the valley.

In the decade a systematic Survey and Settlement operations were undertaken and the old *Mustajiri* or revenue farming system is being replaced by the *Ryotwari* system. The settlement work was in progress towards the close of the decade. In the decade there has been no famine but the condition of crops has not, on the whole, been quite satisfactory. In 1922 and 1924 there was excessive rainfall and in the latter year the crops were below the normal. In 1925 owing to the shortage of winter rains crops somewhat suffered in few places. The floods in the Narbada in September 1926 caused considerable damages in the southern *Tahsils*. In the latter year, frost and locust did considerable damage to the crops and the monsoon in 1929 was below normal. It is reported that on the whole the decade was not one of marked or continuous agricultural prosperity.

There was no extension of railway lines but 86 miles of metalled roads were constructed. 11 Co-operative banks and 709 new societies came into existence

Population, Density and Variation—Bhopal.

Bhopal.	Popula- tion 1931.	Density.	VARIATION PER CENT.	
			1921-1931.	1911-1921.
1	2	3	4	5
State Total	729,955	106	+5.4	-6.2
Nizam-i-Maghrib	387,530	120	+10.9	+1.1
Nizam-i-Mashriq	342,425	93	-0.2	-5.9

thus making a total of 25 banks and 1,160 societies. In the Nizam-i-Maghrib which includes the City of Bhopal, there has been a general increase, the most marked being in the City itself where the population has increased by 35.3 per cent. In the rural areas there is a decrease in Bhopal (Huzur) *Tahsil* (-6.1) and in Nasrullaganj (-3.3). The highest increase is in Doraha *Tahsil* (+20.5). The southern tracts, *i.e.*, below the Vindhya show decrease in several *Tahsils*, *viz.*, Raisen, Goharganj and Begamganj. These parts were affected by the seasonal calamities and the floods in the Narbada. According to the vital statistics supplied by the State the total births were 196,099 and deaths 162,181. The computed population comes to 726,366 as against the actual population of 729,955. This would suggest the State has gained by migration but complete migration statistics are not available. The few incomplete figures available for the adjacent provinces show that

the State loses by emigration. No reliance can however be placed on the registered vital statistics.

Rajgarh, Narsingharh and Khilchipur.—These three States are situated on the plateau. Narsingharh and Rajgarh are inextricately mixed up. The northern

Population, Density, and Variation—Other Bhopal Agency States.

State.	Popula- tion in 1931.	Density.	VARIATION PER CENT.	
			1921-31.	1911-21.
1	2	3	4	5
Khilchipur . . .	45,583	167	+13.8	—0.1
Narsingharh . . .	113,873	155	+12.3	—7.7
Rajgarh . . .	134,891	140	+17.6	—9.7

portion of Rajgarh is much cut up by hills but the southern and eastern portions lie on the plateau. Khilchipur is mainly situated in the Deccan trap area but the northern portions are covered with a rough stony soil of little agricultural value. Though there was no famine or scarcity in these parts, yet the condition of the crops was not quite satisfactory from 1922 to 1926. The rainfall was defective and not well distributed. The *Kharif* crop which is the chief crop in these parts was off and on damaged though the *Rabi* was uniformly good. In 1928 and 1929 wheat was damaged by rust. These local variations were however not serious. The rise in the population shows that these areas have recovered from the previous adverse effects due to the Influenza epidemic.

47. Malwa and Southern States Agency.—These two Agencies have been amalgamated since the last Census and placed under the charge of a Political Agent who stays in Manpur¹ round about which is an area of 49 square miles constituting the British *Pargana* of that name. The area of these combined Agencies is 8,102 square miles and the population, 1,109,784. Excepting the State of Indore, these Agencies include all the States in the western, central and southern Malwa.

Malwa Agency States.—The two Dewas States, Ratlam, Sailana and Sitamau, Jaora and the minor units of Panth-Piploda and Piploda are included in this charge. Except the *Pargana* of

Population, Density and Variation—Malwa States.

State.	Popula- tion 1931.	Density.	VARIATION PER CENT.	
			1921-1931.	1911-1921.
1	2	3	4	5
Dewas (Senior) . . .	83,321	186	+8.2	+1.7
Dewas (Junior) . . .	70,513	168	+5.2	+5.3
Jaora . . .	100,166	166	+16.8	+3.9
Ratlam . . .	107,321	155	+25.5	+3.6
Sailana . . .	35,223	126	+29.7	—5.0
Sitamau . . .	28,422	141	+7.1	+0.2

Bagaud, the whole area of the two Dewas States lies on the plateau. Ratlam and Sailana are inextricably mingled and in both large areas are alienated in *jagirs*. In the plateau portions of the States the soil is of the high fertility common to Malwa. Jaora and Sitamau wholly lie on the plateau. In both the soil is richest in Malwa and was formerly bearing excellent crops of poppy. The seasonal and economic conditions were on the whole normal. There was no scarcity or epidemic. Rainfall was unevenly distributed. Only one year was perhaps bad in some places. At least 6 years were fair and some even good. These parts escaped damage due to locusts. The highest increase of population has taken place in Ratlam and Sailana. Part of the growth in Ratlam is due to the growth in the urban area of Ratlam City which has a little more than one-third of the total State population. The City population has increased by 25 per cent. in the decade. The highest increase has taken place in the Bajna *Tahsil* which has 93 per cent. Bhil population. In Sailana the Raoti *Tahsil*, which is a hilly area and has 85 per cent. Bhil population, shows an increase of 40.3 per cent. and another *Tahsil* Bilpank which decreased by 18.6 per cent. in the previous decade shows an increase of 40.3 per cent. The town of Sailana has also increased by over 40 per cent. The Bhil population has contributed to the great increase in these two States. In Jaora Tal and Jaora *Parganas* show great decrease while others show large increase. Owing to the interlacing of jurisdictions movement from one jurisdiction to another is common and unless complete migration statistics are available by smaller units of the adjoining States, it is difficult to account for such vagaries which the figures show.

¹ As the report is passing through the press the head-quarters of the Political Agent have been transferred to Indore on the rendition of Manpur.

Southern Central India States Agency.—This Agency includes the States of Ali-Rajpur, Barwani, Dhar, Jhabua, Jobat and six small Estates. Only Dhar

Population, Density and Variation—Southern States.

State.	Popula- tion in 1931.	Density.	VARIATION PER CENT.	
			1921-1931.	1911-1921.
1	2	3	4	5
Ali-Rajpur . . .	101,963	122	+14.1	+23.3
Barwani . . .	141,110	120	+17.4	+10.7
Dhar . . .	243,430	136	+5.9	+19.8
Jhabua . . .	145,522	109	+17.4	+11.4

lies partly on the plateau and partly on the hilly portion of the Vindhya and the valley below. Ali-Rajpur and Jhabua wholly lie on the Vindhya and Barwani territory falls between the Narbada and the Satpuras. Ali-Rajpur country is a poor one, intersected by narrow valleys and the low-Vindhyan ranges, covered with jungles. Barwani internally falls into two sub-divisions: one portion consisting of a strip of the Narbada valley with a small breadth from the southern bank of the river to the foot of the Satpura ranges formed of a fertile alluvial plain and the rest of the State which is traversed by the Satpura ranges. The *Ghata* or hilly tract in Jhabua which makes up a greater part of the State, is of low fertility and incapable of irrigation. Only the land along the Mahi river is cultivable. A large portion of this State is alienated and is held as fief by the nobles, the *Umraos*. The economic condition of the decade in all these States is reported to be good. There was no scarcity anywhere necessitating relief measures on any scale. In Ali-Rajpur no regular survey and settlement has been introduced. The revenue assessment is made on the number of ploughs in actual use of the cultivator. In Dhar a fresh revision of the settlement is nearing completion. With a view to open up the Nimanpur *Pargana* a road of 21 miles long is under construction. One feature of the decade reported from Dhar State is the impetus that cotton ginning and cotton trade have received. Previously the quantity of cotton produced in the State proper (exclusive of guaranteed Estates) was not more than 140,000 bales but the export now in a normal year is 300,000 bales, valuing between 40 and 50 lakhs. A large increase in trade is reported from Dhar. Great demand for and consequent rise in the price of cotton, led to its widespread cultivation both in Malwa and Nimar divisions of the State even to the exclusion of other commodities. Many cultivators had to buy foodstuffs for their own consumption. With the fall in the price of cotton they have resumed the cultivation of food-grain. In Ali-Rajpur all the *Tahsils* show an increase and the density varies from 68 to 175 per square mile. Similarly in Barwani the density varies from 42 in Pati *Pargana* in the Satpuras to 207 in Anjar *Pargana* which is situated in the Narbada valley. All the *Tahsils* have increased their population in the decade. Dhar is the only State in this Agency where the increase is below ten per cent. It is surprising in the State proper the *Mahals* on the plateau have lost heavily. The increase is marked solely in the three hilly *Mahals*—Mandu, Nalcha and Nimanpur—which have contributed nearly three quarters of the increase. Permanent migration and settlement in Nimanpur *Mahal* is reported. This and the increase of the Bhil population in the hilly *Mahals* have contributed to the general increase in population.

48. **Bundelkhand Agency.**—This Agency has an area of 10,081 square miles and its population is 1,289,015, giving a mean density of 128. There are 9 Salute

Population, Density and Variation—Bundelkhand States.

State.	Popula- tion in 1931.	Density.	VARIATION PER CENT.	
			1921-1931.	1911-1921.
1	2	3	4	5
Ajaigarh . . .	85,895	107	+1.3	—2.6
Baoni . . .	19,132	158	—3.1	—1.9
Bijawar . . .	165,852	119	+3.7	—10.8
Charkhari . . .	120,351	137	—2.5	—6.9
Chhatarpur . . .	161,267	143	—3.2	—7.4
Datia . . .	153,834	174	+6.8	—3.8
Orchha . . .	314,661	151	+10.4	—13.7
Panna . . .	212,130	82	+7.4	—13.7
Samthar . . .	33,307	185	+0.3	+4.1
Rest of Agency . . .	67,586	166	—0.4	—2.0

States and 13 other minor States in this Agency. Of the total area, about 8,000¹ square miles lie on the level country to the west of the Panna hills and the rest is included in the rugged tract of the Vindhyan off-shoots. To the west of the Dhasan there are three States—Orchha, Datia and Samthar. Orchha lies mostly on the level plain of the Betwa-Dhasan *doab*, Datia on the level country between the Sind and the Betwa rivers and Samthar on the

¹ This is only approximate.

unbroken level plain between the British Bundelkhand districts of Jhansi and Jalaun. East of the Dhasan up to the Panna hills the States of Charkhari, Chhatarpur, Bijawar, Panna and Ajaigarh are all fragmented in various degrees. A greater part of Panna lies on the Vindhya, known as the Panna range. Charkhari has 9 detached portions 8 of which are enclosed in the British district of Hamirpur. Ajaigarh is much cut up by hills and valleys. Three of the four *Parganas* in Bijawar are cut up by the series of jungle covered spurs which shoot out from the Panna range. Only the greater part of Chhatarpur State lies on a level plain, covered with trees and watered by numerous tanks. The remaining small States are dotted all over the map in a most confused manner. Bundelkhand is by no means a favoured region. It is subject to scarcity and drought. Communications are meagre and the tract has not yet been opened up. The States are still in a state of isolation and administration in most places requires levelling up. The soil is poor and nowhere is it of high fertility. Tanks are numerous but many are not in use. In the decade the first half was favourable and the economic and seasonal conditions were satisfactory. In the second half locust and frosts did damage in several parts. There was no serious scarcity or famine or epidemic anywhere. The conditions were normal on the whole. In the previous decade the Agency was badly affected by the Influenza epidemic and the recovery in most places has been slow. In Charkhari, Baoni and Chhatarpur population has fallen. Adverse economic and administrative conditions cause migration to the neighbouring parts. In the absence of migration statistics it is not possible to estimate the fall in population due to emigration.

49. **Baghelkhand Agency.**—This Agency has an area of 14,706 square miles and its population is 1,839,256, the mean density being 125. It consists of the

Population, Density and Variation—Baghelkhand States.

State.	Popula- tion in 1931.	Density.	VARIATION PER CENT.	
			1921-1931.	1911-1921.
1	2	3	4	5
Baraundha . . .	16,071	74	+1.0	-6.3
Maihar . . .	68,991	170	+3.7	-9.0
Nagod . . .	74,589	149	+9.4	-8.6
Rewa . . .	1,587,445	122	+13.3	-7.5
Northern Divi- sion.	660,943	188	+6.9	-4.2
Southern Divi- sion.	926,502	98	+18.3	-10.0
Kothi . . .	21,424	127	+6.7	-5.7
Sohawal . . .	42,192	198	+10.8	-9.0
Other States. . .	28,544	144	+0.8	-3.9

Salute States of Baraundha, Maihar, Nagod and Rewa and the non-Salute States of Sohawal and Kothi. There is a group of Jagirs—six in number—known as the *Charabz Jagirs*. Rewa is the largest State in the Agency. This State falls into two well-marked divisions which are separated by the Kaimur range. North of the range is a wide alluvial plain with an area of 3,515 square miles; to the south the country is traversed by hills and the whole area is covered with dense forests. The Northern

Division has a density of 188 while that of the South is 98 only. The condition of the crops from 1921-26 was very good and after several years, the countryside enjoyed a fair continuation of good years. In the latter half there was a small set back due to rust and ill-timed and badly distributed rainfall. In the northern plains of Rewa water is plentiful and there are large tanks and reservoirs but as a rule these are not used for irrigation. The chief source of irrigation is from embankment locally known as *bandh*. Every slope and every small ravine in the villages are embanked. The water is allowed to remain in the embankment till October when it is drained away by cutting the *bandh* and wheat is then sown in the area which was formerly under water. This system of irrigation suits the local agricultural needs. During the decade the whole of the State has been settled and 40 miles of metalled road and 30 miles of railway known as the Central India Coalfield Railway from Anuppur on the Katni-Bilaspur branch of the Bengal-Nagpur Railway to the borders of the Korea-Rewa States were constructed. The Southern Division is a wild unopened part and no real development has yet been attempted. It is the most backward and inaccessible part in Central India. The Southern Division in Rewa has increased more than the northern plains. The primitive tribes are all concentrated in the former area. The other States in this Agency have recovered fairly well.

Section V.—Houses and Families.

50. The definition of a house has remained the same since 1901. A house was defined for Census purposes as :—

- (i) any structure other than a dwelling house such as tent, pavilion, temple, *serai*, etc., or a site, camping ground, *ghat*, etc., to which a separate number has been affixed.
- (ii) the dwelling place of one commensal family with its dependant and resident servants having an independent entrance, whether that entrance be from a road, gallery, balcony, corridor, courtyard or otherwise.

In this Agency, the house is therefore the dwelling place of a single commensal family which eats from one and the same *Chulha*.

In Imperial Table I the number of occupied houses distributed in towns and in villages is given. There are now 169,626 occupied houses in towns and 1,264,085 in villages. In 1921, 144,598 were in towns and 1,174,677 in villages. The total number of houses has increased by 8·6 per cent. while the population has gone up by 10·5 per cent. The urban population has increased by 23 per cent. while the number of urban houses has increased by 17·3 per cent. The increase in the houses has not kept pace with the increase in population, indicating there is no decided spread of the ideas of a better standard of living in the rural and urban areas. What constitutes a house is now well-known to the State Census officials though the over-zealous are apt to give a number to all kinds of odd places. The house itself varies in range from the scanty hut of the primitive Bhil or Baiga on whose house there is no place to put a number but a tin plate with a number on it has to be stuck in, to the palatial residence of a Maharaja.

In Subsidiary Table VII the average number of persons per house and the average number of houses per square mile is given. In the former the figures remain the same whereas in the latter the average now shows an increase of 1 over that of 1921. The various units practically show no change with regard to the average number of persons per house in the last two Censuses. No special enquiry has been made as to the trend of the joint family system. The figures do not show that it is breaking. In the better classes no doubt the family tends to separate when the members become economically independent. But, in these days of economic stress and strain it is after all not bad if families do not split up.

SUBSIDIARY TABLE I.

Density, Water Supply and Crops.

Agency, Natural Divisions and States.	Mean density per Sq. mile in 1931.	PERCENTAGE OF TOTAL AREA.		PERCENTAGE OF CULTIVABLE AREA.		Percentage of gross cultivated area which is irrigated.	Normal rainfall.	PERCENTAGE OF GROSS CULTIVATED AREA UNDER													
		Cultivable.	Net cultivated.	Net cultivated.	Double crop.			Rice.	Wheat.	Gram.	Jowar.	Bajra.	Sajzi.	Kodan.	Other food-grains and pulse, etc.	Oil seeds.	Sugarcane.	Poppy.	Cotton.	Tobacco.	Miscellaneous.
1	2	3	4	5	6	7	8	9	10	11	12	13	14	15	16	17	18	19	20	21	22
CENTRAL INDIA AGENCY.	129	53.89	31.62	58.62	4.56	7.03	36.95	8.09	16.79	8.31	16.51	1.93	5.00	5.21	11.81	7.62	.21	.12	12.83	.12	5.33
West	130	54.89	31.39	58.81	2.67	1.99	33.39	1.88	20.74	5.88	23.03	3.11	7.53	.50	7.67	4.94	.15	.18	21.50	.11	2.78
British Pargana of Manpur.	140	33.26	21.82	65.60	3.60	.96	35.40	2.00	22.86	10.60	30.94	.08	13.62	..	1.30	.78	15.93	..	1.81
Indore	138	41.47	35.25	85.00	1.75	1.94	30.98	.63	16.53	3.32	30.68	4.78	3.60	.18	4.56	2.97	.07	.15	31.51	.11	.91
<i>Bhopal Agency.</i>																					
Bhopal	106	59.57	30.98	52.01	1.86	.93	Not available. 33-73	1.48	39.40	10.21	11.22	.03	.74	.83	11.32	10.08	.19	..	9.18	.15	4.17
Khilchipur	167	55.26	38.44	69.75	7.62	7.60	..	1.17	6.29	1.86	42.59	..	12.84	..	2.15	..	.13	..	22.68	..	10.29
Narsinggarh	155	77.28	42.57	76.02	2.80	3.22	37.62	1.12	9.47	2.81	39.53	..	3.76	..	7.53	.93	.26	..	32.54	.02	2.03
Rajgarh	140	88.10	39.46	44.79	1.49	2.91	41.70	.81	9.94	3.03	42.78	..	6.46	..	4.69	4.04	.92	..	26.50	.02	1.16
<i>Malwa Agency.</i>																					
Dewas States	177	70.04	48.89	69.79	1.80	2.03	33.55	.28	22.84	4.23	39.12	2.38	2.59	..	.84	1.79	.16	.11	22.42	.12	3.07
Jaora	166	92.53	46.35	50.09	3.44	7.05	31.17	.07	11.63	34.98	2.41	..	4.29	..	13.26	7.33	.15	2.11	22.42	.02	1.33
Ratlam	155	44.97	33.05	73.49	1.54	3.11	30.18	3.12	23.02	7.25	15.11	.02	11.76	1.55	3.15	4.30	.10	.90	23.14	..	1.58
Sailana	126	90.85	49.96	50.50	1.15	3.57	26.21	2.51	5.35	8.33	15.41	..	12.53	1.43	1.19	4.48	.24	.36	25.44	..	2.73
Sitamau	141	54.60	35.34	64.71	7.20	10.21	Not available.	.44	5.77	6.45	43.41	1.78	7.85	..	3.07	1.43	.07	5.10	22.26	..	2.37
<i>Southern Central India States Agency.</i>																					
Barwani	120	49.41	33.66	68.13	.94	1.12	23.93	1.77	4.17	1.73	27.83	21.81	6.08	..	8.35	3.65	.22	..	23.69	..	.71
Dhar	136	74.14	53.16	71.70	1.76	1.73	31.36	.86	23.95	5.97	18.44	3.87	6.64	1.42	3.36	4.54	.05	.02	21.65	.32	3.91
Jhabua	109	77.17	65.78	85.24	13.50	1.24	Not available.	9.07	4.86	9.90	.52	.48	35.86	..	19.41	4.79	.05	..	10.54	.03	4.49
Jobat	155	73.82	45.09	61.09	3.55	.03	29.82	3.30	.20	5.16	10.21	5.98	25.62	5.72	14.87	5.9896	..	22.00
East	127	52.81	26.17	49.29	6.36	14.01	40.51	16.38	11.32	11.68	7.57	.31	1.49	11.79	17.54	11.34	.29	.03	.85	.12	8.99
<i>Bundelkhand Agency.</i>																					
Ajalgarh	107	52.52	36.64	69.77	.95	3.48	46.35	10.98	17.04	21.12	10.03	.01	.59	13.61	11.73	10.19	.03	..	.16	.02	4.64
Baoni	158	80.48	46.80	58.13	.07	8.24	32.33	..	22.25	43.36	12.61	3.89	7.43	8.1819	.06	2.03
Bijawar	119	62.96	25.75	40.90	7.07	17.10	43.95	8.00	4.60	3.72	8.89	..	7.10	18.06	44.48	13.8201	1.32
Charkhari	137	71.82	37.61	52.37	.60	5.64	34.91	1.04	17.12	24.46	4.07	.39	..	4.02	27.79	11.55	.05	..	1.73	.06	.67
Chhatarpur	143	37.66	23.58	62.62	8.89	36.98	40.13	1.96	8.03	5.19	10.98	..	.06	17.91	31.36	19.16	.20	..	.18	..	4.98
Datia	174	55.77	42.61	76.41	11.50	3.58	37.21	.50	15.29	14.22	23.12	.13	.13	..	4.01	8.14	.19	..	.94	..	2.03
Orchha	159	57.14	18.61	32.57	21.69	53.09	36.88	6.12	10.02	12.42	10.73	..	.11	1.07	11.41	6.89	1.03	.30	4.26	1.24	34.40
Panna	82	60.48	23.08	38.15	2.35	72.99	48.81	12.75	5.07	5.22	6.78	..	1.25	10.12	46.42	9.68	.12	..	.10	.02	2.47
Samthar	185	75.60	54.43	72.10	.03	17.52	32.64	.08	30.29	24.42	38.61	1.20	..	.06	2.07	.64	1.20	..	1.43
<i>Baghelkhand Agency.</i>																					
Kothi	127	28.00	24.99	39.23	.69	2.36	Not available. 45-62	1.93	6.93	18.39	22.13	.04	.02	29.46	14.73	6.07	.07	..	.05	.18	..
Maihar	170	58.80	16.78	28.55	5.13	.48	45-62	35.44	23.63	12.93	3.73	..	1.43	7.26	.05	10.03	.0804	.35
Nagod	149	55.29	35.93	65.00	3.08	.31	47.17	15.52	16.21	13.55	2.96	.09	.47	15.66	25.04	8.58	.03	..	.30	.10	1.49
Rewa	122	49.20	24.64	50.08	6.12	.11	55.17	26.96	10.27	5.89	2.06	.25	2.05	15.65	13.66	12.78	.30	..	.45	..	9.68
Sohawal	198	76.58	40.63	53.60	1.78	..	Not available.	7.85	19.47	14.07	9.35	.30	.01	22.16	7.04	5.55	.76	..	.04	.05	13.35

NOTE.—Figures for Al-Rajpur and Baraundha are not available. Information for the Minor States being incomplete has been omitted.

SUBSIDIARY TABLE II.

Distribution of the Population classified according to Density.

Agency, Natural Divisions and States.	Density per square mile.	UNITS WITH A POPULATION PER SQUARE MILE OF			
		UNDER 150.		150—300.	
		Area.	Population 000's omitted.	Area.	Population 000's omitted.
1	2	3	4	5	6
CENTRAL INDIA AGENCY	129	44,316 85.9	5,436 82.0	7,281 14.1	1,196 18.0
West	130	23,442 45.4	2,945 44.4	3,300 6.4	541 8.2
1. British Pargana of Manpur	140	49	7
2. Indore	138	9,518	1,318
<i>Bhopal Agency.</i>					
3. Bhopal	106	6,902	730
4. Khilchipur	167	273	46
5. Narsingharh	155	734	114
6. Rajgarh	140	962	135
<i>Malwa Agency.</i>					
7. Dewas States	177	868	154
8. Jaora	166	602	100
9. Ratlam]	155	693	107
10. Sailana	126	279	35
11. Sitamau	141	202	28
<i>Southern Central India States Agency.</i>					
12. Ali-Rajpur	122	836	102
13. Barwani	120	1,178	141
14. Dhar	136	1,784	243
15. Jhabua	109	1,336	146
16. Jobat	155	130	20
East	127	20,874 40.5	2,491 37.5	3,981 7.7	655 9.9

SUBSIDIARY TABLE II—concl'd.

Distribution of the Population classified according to Density—concl'd.

Agency, Natural Divisions and States.	Density per square mile.	UNITS WITH A POPULATION PER SQUARE MILE OF			
		UNDER 150.		150—300.	
		Area.	Population 000's omitted.	Area.	Population 000's omitted.
1	2	3	4	5	6
<i>Bundelkhand Agency.</i>					
17. Ajaigarh	107	802	86
18. Baoni	158	121	19
19. Bijawar	119	973	116
20. Charkhari	137	880	120
21. Chhatarpur	143	1,130	161
22. Datia	174	912	159
23. Orchha	159	2,080	315
24. Panna	82	2,596	212
25. Samthar	185	180	33
<i>Baghelkhand Agency.</i>					
26. Baraundha	74	218	16
27. Kothi	127	169	21
28. Maihar	170	407	69
29. Nagod	149	501	75
30. Rewa	122	13,000	1,587
31. Sohawal	198	213	42
Rest of Central India Agency	156	1,069	175

NOTE.—Figures for Khaniadhana are included in the East. The figures below the absolute ones represent the proportion per cent. which the area and population of each density group bear to the total area and population.

SUBSIDIARY TABLE III.

Variation in Relation to Density since 1891.

Agency, Natural Divisions and States.	Percentage of variation : Increase (+) Decrease (—).				Net variation.			Mean Density per square mile.				
	1921-1931.	1911-1921.	1901-1911.	1891-1901.	1911-1931.	1901-1931.	1891-1931.	1931.	1921.	1911.	1901.	1891.
1	2	3	4	5	6	7	8	9	10	11	12	13
CENTRAL INDIA AGENCY	+10.5	-2.1	+12.8	..	+8.1	+22.0	..	129	116	119	105	..
West	+12.2	+4.2	+15.9	..	+16.8	+35.5	..	130	116	112	96	..
1. British Pargana of Manpur	+50.0	-30.9	+35.2	-8.5	+3.7	+40.1	+28.3	140	93	135	100	109
2. Indore	+14.5	+9.4	+16.3	-20.8	+25.3	+45.8	+15.5	138	121	111	95	120
<i>Bhopal Agency.</i>												
3. Bhopal	+5.4	-6.2	+8.7	-29.5	-1.1	+7.5	-24.2	106	100	107	98	140
4. Khilchipur	+13.8	-1	+28.7	-14.2	+13.7	+46.4	+20.1	167	147	147	114	133
5. Narsinghgarh	+12.3	-7.7	+19.3	-20.8	+3.7	+23.7	-2.1	155	138	150	125	158
6. Rajgarh	+17.6	-9.7	+34.1	..	+6.2	+42.4	..	140	119	132	98	..
<i>Malwa Agency.</i>												
7. Dewas States	+6.8	+7.0	+32.8	-21.4	+10.4	+28.7	+1.2	177	166	161	138	175
8. Jaora	+16.7	+3.9	-1.4	..	+21.3	+19.7	..	166	142	137	139	..
9. Ratlam	+25.5	+3.6	-2.9	-4.8	+30.1	+26.5	+20.4	155	123	119	122	129
10. Sailana	+29.7	-5.0	+10.7	-18.0	+23.2	+36.4	+11.8	126	97	102	93	113
11. Sitamau	+7.0	+2	+11.0	-28.4	+7.3	+19.1	-14.7	141	131	139	118	165
<i>Southern Central India States Agency.</i>												
12. Ali-Rajpur	+14.0	+23.3	+44.4	-28.4	+40.7	+103.2	+45.5	122	107	87	60	84
13. Barwani	+17.4	+10.7	+42.6	-5.1	+30.0	+85.3	+75.8	120	102	92	65	68
14. Dhar	+5.9	+19.2	+12.0	..	+26.1	+42.0	..	136	129	108	96	..
15. Jhabua	+17.4	+11.4	+37.2	-32.3	+30.8	+79.3	+21.4	109	93	83	61	90
16. Jobat	+10.1	+17.6	+64.8	-37.2	+29.5	+113.4	+33.9	155	141	120	73	116
East	+8.7	-8.1	+10.1	-11.9	-1	+10.0	-3.0	127	116	127	115	130
<i>Bundelkhand Agency.</i>												
17. Ajaigarh	+1.3	-2.6	+11.3	-15.9	-1.4	+9.8	-7.7	107	106	109	98	116
18. Baoni	-3.1	-1.9	+1.7	+7.3	-4.9	-3.3	+3.7	158	163	166	163	152
19. Bijawar	+3.7	-10.8	+13.3	-10.5	-7.5	+4.8	-6.1	119	115	129	114	127
20. Charkhari	-2.5	-6.9	+6.9	-13.4	-9.2	-2.9	-15.9	137	140	151	141	163
21. Chhatarpur	-3.2	-7.4	+5.4	-9.4	-10.4	-5.5	-14.4	143	147	159	151	167
22. Datia	+6.8	-3.8	-11.1	-6.7	+2.7	-8.7	-14.8	174	163	170	191	204
23. Orchha	+10.4	-13.7	+2.6	-3.4	-4.7	-2.2	-5.5	151	137	159	155	160
24. Panna	+7.4	-13.7	+18.6	-19.4	-7.3	+9.9	-11.4	82	76	88	74	92
25. Samthar	+3	+4.1	-4.7	-17.4	+4.4	-5	-17.8	185	185	177	186	225
<i>Baghel'hand Agency.</i>												
26. Baraundha	+1.0	-6.3	+8.0	-15.4	-5.4	+2.2	-13.6	74	73	78	72	85
27. Kothi	+6.7	-5.7	+11.3	-15.5	+6	+11.9	-5.4	127	119	126	113	134
28. Maihar	+3.7	-9.0	+14.5	-17.6	-5.7	+8.0	-11.0	170	163	180	157	191
29. Nagod	+9.4	-8.6	+18.8	-25.3	-0	+18.7	-11.3	149	136	149	125	168
30. Rewa	+13.3	-7.5	+14.2	-12.0	+4.8	+19.6	+5.3	122	108	117	102	116
31. Sohawal	+10.8	-9.0	+12.2	-15.0	+9	-13.2	-3.8	198	179	196	175	206
Rest of Central India Agency.	+4.2	-3	+10.7	..	+3.9	+15.0	..	163	156	157	142	..

NOTE.—Figures for Khaniadhana are included in the East.

SUBSIDIARY TABLE IV.

Variation in Natural Population.

Agency, Natural Divisions and States.	POPULATION IN 1931.				POPULATION IN 1921.				Variation per cent. 1921-31 in natural population: increase +, decrease—.
	Actual population.	Immigrants.	Emigrants.	Natural population.	Actual population.	Immigrants.	Emigrants.	Natural population.	
1	2	3	4	5	6	7	8	9	10
CENTRAL INDIA AGENCY	6,632,790	598,102	482,294	6,516,982	6,002,551	548,094	485,054	5,933,983	+10
West	3,486,849	441,457	3,108,764	398,362	207,099	2,897,354	
1. British Pargana of Manpur.	6,852	2,360			4,565				
2. Indore	1,318,237	307,974			1,150,840				
<i>Bhopal Agency.</i>									
3. Bhopal	729,955	63,621			692,448				
4. Khilchipur	45,583	9,830			40,043				
5. Narsinghgarh	113,873	31,093			101,426				
6. Rajgarh	134,891	28,527			114,714				
<i>Malwa Agency.</i>									
7. Dewas States	153,834	48,038	Figures not available.		144,003	Figures not available.			
8. Jaora	100,166	23,874			85,778				
9. Ratlam	107,321	32,727			85,489				
10. Sailana	35,223	11,678			27,165				
11. Sitamau	28,422	7,387			26,549				
<i>Southern Central India States Agency.</i>									
12. Ali-Rajpur	101,963	5,735			89,364				
13. Barwani	141,110	19,904			120,150				
14. Dhar	243,430	62,321			229,771				
15. Jhabua	145,522	11,661			123,932				
16. Jobat	20,152	3,340			18,296				
East	3,145,941	165,167			2,893,787	149,732	277,955	3,036,629	
<i>Bundelkhand Agency.</i>									
17. Ajaigarh	85,895	18,055			84,790				
18. Baoni	19,132	4,120			19,734				
19. Bijawar	115,852	15,059			111,723				
20. Charkhari	120,351	30,175			123,405				
21. Chhatarpur	161,267	22,154	Figures not available.		166,549	Figures not available.			
22. Datia	158,834	24,220			148,659				
23. Orchha	314,661	24,849			284,948				
24. Panna	212,130	31,032			197,600				
25. Samthar	33,307	9,166			33,216				
<i>Baghelkhand Agency.</i>									
26. Baraundha	16,071	2,657			15,912				
27. Kothi	21,424	5,128			20,087				
28. Maihar	68,991	13,057			66,540				
29. Nagod	74,589	14,700			68,166				
30. Rewa	1,587,445	48,031			1,401,524				
31. Sohawal	42,192	11,755			38,078				
Rest of Central India Agency.	174,115	..			167,087				

NOTE.—Figures for Khaniadhana are included in the East.

SUBSIDIARY TABLE VI.

Variation by Natural Divisions and States classified according to Density.

Agency, Natural Divisions and States.	Decade.	(a) ACTUAL FIGURES.		(b) PROPORTIONAL FIGURES.	
		VARIATION IN POLITICAL CHARGE AND NATURAL DIVISION WITH A POPULATION PER SQUARE MILE AT COMMENCEMENT OF DECADE OF		VARIATION IN POLITICAL CHARGE AND NATURAL DIVISION WITH A POPULATION PER SQUARE MILE AT COMMENCEMENT OF DECADE OF	
		Under 150.	150-300.	Under 150.	150-300.
1	2	3	4	5	6
CENTRAL INDIA AGENCY	1921-31	+511,375	+118,864	+10·5	..
West	+306,107	+71,978	+12·2	..
1. British Pargana of Manpur	+2,287	..	+50·0	..
2. Indore	+167,397	..	+14·5	..
<i>Bhopal Agency.</i>					
3. Bhopal	+37,507	..	+5·4	..
4. Khilchipur	+5,540	..	+13·3
5. Narsingharh	+12,447	..	+12·3
6. Rajgarh	+20,177	..	+17·6	..
<i>Malwa Agency.</i>					
7. Dewas States	+9,831	..	+6·8
8. Jaora	+14,388	..	+16·7
9. Ratlam	+21,832	..	+25·5
10. Sailana	+8,058	..	+29·7	..
11. Sitamau	+1,873	..	+7·0	..
<i>Southern Central India States Agency.</i>					
12. Ali-Rajpur	+12,599	..	+14·0	..
13. Barwani	+20,960	..	+17·4	..
14. Dhar	+13,659	..	+5·9	..
15. Jhabua	+21,590	..	+17·4	..
16. Jobat	+1,856	..	+10·1
East	+205,268	+46,886	+8·7	..
<i>Bundelkhand Agency.</i>					
17. Ajaigarh	+1,105	..	+1·3	..
18. Baoni	-602	..	-3·1
19. Bijawar	+4,129	..	+3·7	..
20. Charkhari	-3,054	..	-2·5	..
21. Chhatarpur	-5,282	..	-3·2	..
22. Datia	+10,175	..	+6·8
23. Orchha	+29,713	..	+10·4
24. Panna	+14,530	..	+7·4	..
25. Samthar	+91	..	+3
<i>Baghelkhand Agency.</i>					
26. Baraundha	+159	..	+1·0	..
27. Kothi	+1,337	..	+6·7	..
28. Maihar	+2,451	..	+3·7
29. Nagod	+6,423	..	+9·4	..
30. Rewa	+185,921	..	+13·3	..
31. Sohawal	+4,114	..	+10·8
Rest of Central India Agency	+7,028	..	+4·2

NOTE.—Figures for Khaniadhana are included in the East.

SUBSIDIARY TABLE VII.

Persons per House and Houses per square mile.

Agency, Natural Divisions and States.	AVERAGE NUMBER OF PERSONS PER HOUSE.			AVERAGE NUMBER OF HOUSES PER SQUARE MILE.		
	1931.	1921.	1911.	1931.	1921.	1911.
1	2	3	4	5	6	7
CENTRAL INDIA AGENCY	5	5	4	27	26	26
West	5	5	4	29	26	25
1. British Pargana of Manpur	4	4	4	34	25	32
2. Indore	4	4	4	31	27	25
<i>Bhopal Agency.</i>						
3. Bhopal	4	4	4	24	23	24
4. Khilchipur	5	5	5	34	32	32
5. Narsinghgarh	4	4	5	35	32	33
6. Rajgarh	4	4	4	31	28	30
<i>Malwa Agency.</i>						
7. Dewas States	4	4	4	39	37	37
8. Jaora	5	4	4	37	35	33
9. Ratlam	4	4	4	35	31	30
10. Sailana	4	4	4	29	23	23
11. Sitamau	5	4	4	31	31	35
<i>Southern Central India States Agency.</i>						
12. Ali-Rajpur	6	6	6	19	18	14
13. Barwani	6	5	5	21	19	18
14. Dhar	5	5	4	29	26	20
15. Jhabua	5	5	5	21	19	17
16. Jobat	6	6	6	25	24	20
East	5	5	5	27	26	26
<i>Bundelkhand Agency.</i>						
17. Ajaigarh	5	5	5	23	23	23
18. Baoni	5	5	5	34	33	33
19. Bijawar	4	4	4	27	27	30
20. Charkhari	5	5	5	28	28	32
21. Chhatarpur	4	4	4	34	34	35
22. Datia	5	4	5	37	36	32
23. Orchha	4	4	5	36	33	35
24. Panna	4	4	4	19	18	20
25. Samthar	5	5	4	38	38	42
<i>Baghelkhand Agency.</i>						
26. Baraundha	4	4	4	17	16	18
27. Kothi	5	5	5	27	26	27
28. Maihar	4	4	4	41	38	41
29. Nagod	5	4	5	32	30	33
30. Rewa	5	5	5	24	23	23
31. Sohawal	5	5	4	43	39	44
Rest of Central India Agency	5	4	4	37	35	52

NOTE.—Figures for Khaniadhana have been included in the East.

CHAPTER II.

Population of Cities, Towns and Villages.

51. **Statistical reference.**—In this chapter we deal with the urban population, *i.e.*, those living in places classed as towns and cities and with the rural population who constitute the remainder after the urban population is excluded from the general population. The statistics relevant to this chapter will be found in Imperial Table I which gives the general distribution of the urban and rural population ; in Table III containing towns and villages classified by population ; in Table IV where the towns are classified by population with variation since 1881 and in Table V which gives the population of each town by religion. The following four Subsidiary Tables are appended at the end of the chapter :—

- I—Distribution of the Population between Towns and Villages.
- II—Number per mille of each Main Religion who live in Towns.
- III—Towns classified by Population.
- IV—Cities.

52. **Definition of Town and City.**—The Code contained the following definitions :—

Town means (1) every municipality, (2) all civil lines not included within municipal limits, (3) every Cantonment, and (4) every other continuous collection of houses, inhabited by not less than 5,000 persons, which the Provincial Superintendent shall, in consultation with the State Census Officer, decide to treat as a town for census purposes. In States where there are no municipalities this definition will have to be extensively applied.

City means (1) every town containing not less than 100,000 inhabitants and (2) any other town which the Provincial Superintendent with the sanction of the Local Administration or at the request of the State, may decide to treat as a city for census purposes.

53. **Selection of Towns.**—The selection of towns in Indian States for census purposes is not free from difficulty. In many of the States there are practically no municipalities in the sense they are understood elsewhere in British India. A semblance of them is kept up in few places. Most of the towns come under category 4 of the definition laid down which has been liberally applied to include places which ordinarily would not find a place in the list of towns. Secondly, there is always a desire on the part of some of the States to press for the inclusion of small places as an increase in the number of towns is held to be indicative of greater progress during the decade. It is not always possible for the Provincial Superintendent to resist the request and few ineligible places get included. In the smaller States, the capital town is invariably shown as a town even when it falls below 5,000. As regards cities, Indore in the present Census has gone over the minimum limit and it is a city now by right. Bhopal and Ratlam have been treated as cities for local purposes in the previous decades and they have been retained as local cities this time also. As on former occasions, the Cantonments of Mhow and Nowgong and the Indore Residency area are treated as separate towns.

54. **Number of Towns.**—The marginal statement shows the variation by Natural Divisions in the number of towns since the Census of 1891. In the last

Variation in the number of Towns since 1891.

Natural Division.	1931.	1921.	1911.	1901.	1891.
1	2	3	4	5	6
Central India Agency	56	51	49	49	43
West	37	32	31	33	29
East	19	19	18	16	14

thirty years only 7 towns have been added as against the six in 1891-1901. The West has double the number of the towns in the East. Of the number of towns shown in this Census 13 have been added anew since 1901 and 43 have remained in the list since then. Of these 43 towns, the following ten have chang-

ed places in the classes assigned to them :—

(A) From higher to lower class—

1. Datia	III to IV
2. Nowgong	IV to V
3. Ashta	} V to VI
4. Seondha	
5. Govindgarh	

(B) From lower to higher class :—

1. Indore	II to I
2. Khargone	} V to IV
3. Sutna	
4. Tarana	} VI to V
5. Sailana	

The following 33 have remained stationary in the class in which they are now shown :—

Class.	Towns.
Class II 50,000 to 100,000	Bhopal.
Class III 20,000 to 50,000	Ratlam, Rewa, Mhow Cantonment and Jaora.
Class IV 10,000 to 20,000	Dhar, Dewas, Indore Residency, Tikamgarh, Sehore, Maharajgarh, Panna and Chhatarpur.
Class V 5,000 to 10,000	Narsinghgarh, Barwani, Rampura, Mahidpur, Barwaha, Maheshwar, Maihar, Umari, Samthar, Biaora, Rajgarh, Sarangpur, Kuksi, Sitamau, Khilchipur and Bijawar.
Class VI below 5,000	Nagod, Bhanpura, Ichhawar and Berasia.

55. **New Towns.**—The new towns added in this Census are shown in the

New Towns.

Places treated as towns for the first time.	State.	Population.
1	2	3
Ali-Rajpur	Ali-Rajpur	5,149
Anjar	Barwani	4,833
Rajpur	Barwani	5,104
Alot	Dewas	4,691
Badnawar	Dhar	5,197
Dharamपुरi	Dhar	3,753

marginal table. Ali-Rajpur is the capital of the State of the same name. Anjar and Rajpur are flourishing trade centres in Barwani State. Cotton ginning presses have sprung up in the decade and being situated on the main line of communication, they have acquired urban characteristics. Alot and Badnawar are trade centres of local importance. Dharamपुरi is the head-quarters of a Mahal in Dhar State and is besides a place of consider-

able antiquity and pilgrimage.

56. **Of Towns in general.**—Towns in Central India have undergone vicissitudes owing to the kaleidoscopic changes of rulers and historical convulsions. One of the oldest towns dating from early Buddhist days is Ujjain now in Gwalior State. Very little is known about the towns in the mediæval period. During the rule of the Paramara Rajputs in Malwa Dhar, their capital, was a town of considerable importance but it appears to have sunk into comparative insignificance when the Muslim Rulers made Mandu their capital. Sarangpur now in Dewas State was also an important town in that period and it was famed for its fine muslins. With the collapse of the independent Malwa principality, these places sunk into insignificance. The Central Indian Rulers had not the passion to change capitals frequently to found new ones. With the change of capital, Orchha has dwindled to a village and Maheshwar once the capital of Indore State, is now a decadent town. In the past, conditions were not always favourable to the growth of towns. The country was only partially opened and developed. Unlike the Rulers in the northern Indian plains the Central Indian Rulers did not command rich and powerful domains and in the past many towns owed their rise to such Rulers. Again town life is largely dependent on security of life and property and on peace and protection. Towns dwindled wherever these were lacking. In recent times the absence of communications in some parts has arrested the growth of towns.

By far the largest number of towns in Central India are capital towns. Originally they were all fortified settlements of the chiefs nestling in some inaccessible place owing to want of security in the more open parts of the country. Now, they have acquired some urban characteristics and possess the appearance of modern towns. The opening of communications has not been accompanied with any rapid rise in towns. There is only one real industrial town, *viz.*, Indore. Bhopal and Ratlam have expanded beyond the size of a normal capital town owing

to their favourable situation on the main line of communications. Where there is a development of cotton ginning industry and a flow of trade, there is a concentration of towns as in the Narbada valley. Towns like Biaora, Sutna and Umaria, though not capital towns, have acquired some prominence as they are better situated on the line of communication.

The majority of towns are medium-sized and with few exceptions are nothing but over-grown villages. The urban element consists of few trading classes and the officials of the government. There is not much of diversified urban occupation and a good proportion of the town population gets classed in our figures as urban by courtesy.

57. The Urban Population.—The statistics show that out of the total population of 6,632,790 persons enumerated in the Agency, 677,670 have been classed as residing in 56 towns. This gives us 102 per mille urban dwellers for Central India. The proportion of the town dwellers varies in different places as set out in Subsidiary Table I. In Rewa only 3 per cent. are town dwellers. Whereas in Indore 18 per cent. are shown as living in towns. To a conservative peasantry the small towns offer few attractions. There are no compelling forces which would gravitate a move towards urban centres. Industrial towns would deplete the rural parts by attracting labour especially from the landless class. Fortunately there is yet no move towards rural depopulation. The growth of urban population is by natural increase in the places treated as towns and by the inclusion of places which were once rural and which at each Census become urban as soon as they have crossed over the population limit which we have adopted in arbitrarily dividing the classes in Table IV or by the inclusion of any other area which we designate as urban at each Census. The distribution of the urban population according to the size of the towns in which the population lived, is shown in the table below :—

Distribution of population in groups of Towns according to size and in Rural territory, 1901-31.

Class of places.	1931.		1921.		1911.		1901.		PERCENTAGE OF TOTAL POPULATION.			
	Places.	Population.	Places.	Population.	Places.	Population.	Places.	Population.	1931.	1921.	1911.	1901.
1	2	3	4	5	6	7	8	9	10	11	12	13
Total Population .	23,308	6,632,790	21,895	6,002,551	22,189	6,133,764	23,084	5,435,038	100·0	100·0	100·0	100·0
Urban Territory .	56	677,670	51	550,854	49	508,325	49	608,824	10·2	9·2	8·3	11·2
Towns having :—												
I. 100,000 and over	1	127,327	1·9
II. 50,000 to 100,000	1	61,037	1	93,091	1	56,204	2	163,709	0·9	1·6	0·9	3·0
III. 20,000 to 50,000	4	115,056	4	127,941	4	128,971	5	144,893	1·8	2·1	2·1	2·7
IV. 10,000 to 20,000	11	153,747	10	130,746	7	95,073	9	114,718	2·3	2·2	1·5	2·1
V. 5,000 to 10,000	24	160,099	21	144,312	24	175,400	22	138,963	2·4	2·4	2·9	2·6
VI. Under 5,000	15	60,404	15	54,764	13	52,677	11	46,541	0·9	0·9	0·9	0·8
Rural territory .	23,252	5,955,120	21,844	5,451,697	22,140	5,625,439	23,035	4,826,214	89·8	90·8	91·7	88·8

From Subsidiary Table I it appears that 45 per cent. of the urban population live in towns of over 20,000 and 46 per cent. are gathered in towns having population between 5,000 and 20,000. 9 per cent. live in towns under 5,000. But for the Cities of Indore and Bhopal and the garrison station of Mhow the percentage living in towns over 20,000 would have been less. The real concentration is in the medium sized towns having a population of less than twenty thousand. 9 per cent. live in areas which are really not urban, though under our scheme of classification they have found a place in the table. Examining columns 10-13 of the table above, we see there has actually been a decrease of one per cent. in the urban population in the last 30 years and there has been a fall in towns of the second and third class while in classes IV and VI there has been a small rise. The variations given in the table are the result of the passing in and passing out of the towns from one class to another. In Subsidiary Table III, columns 5, 6, 7, 8 and 9 give the variation per cent. in population in towns as classified at previous Censuses. Each column does not deal precisely with the same towns from Census to Census and to obtain a true measure of variation we will have to compare the actual growth of the po-

pulation of the same towns for the Census of 1931 and 1921. This is shown in the table below :—

Variation in population of Towns as classed in 1931.

Class of places.	NUMBER OF PLACES.	POPULATION IN		VARIATION 1921-31.	
		1931.	1921.	Actual.	Per cent.
1	2	3	4	5	6
Total	23,308	6,632,790	6,002,551	+630,239	+10.5
Territory urban 1931	56	677,670	579,629	+98,041	+16.9
Towns having in 1931 :—					
I. 100,000 and over	1	127,327	93,091	+34,236	+36.8
II. 50,000 to 100,000	1	61,037	45,094	+15,943	+35.4
III. 20,000 to 50,000	4	115,056	99,998	+15,058	+15.1
IV. 10,000 to 20,000	11	153,747	134,580	+19,167	+14.2
V. 5,000 to 10,000	24	160,099	152,056	+8,043	+5.3
VI. Under 5,000	15	60,404	54,810	+5,594	+10.2
Territory rural 1931	23,252	5,955,120	5,422,922	+532,198	+9.8

In the decade there has been a great increase in the towns over 50,000 and the towns between 10,000 and 50,000 have increased more than the provincial rise in

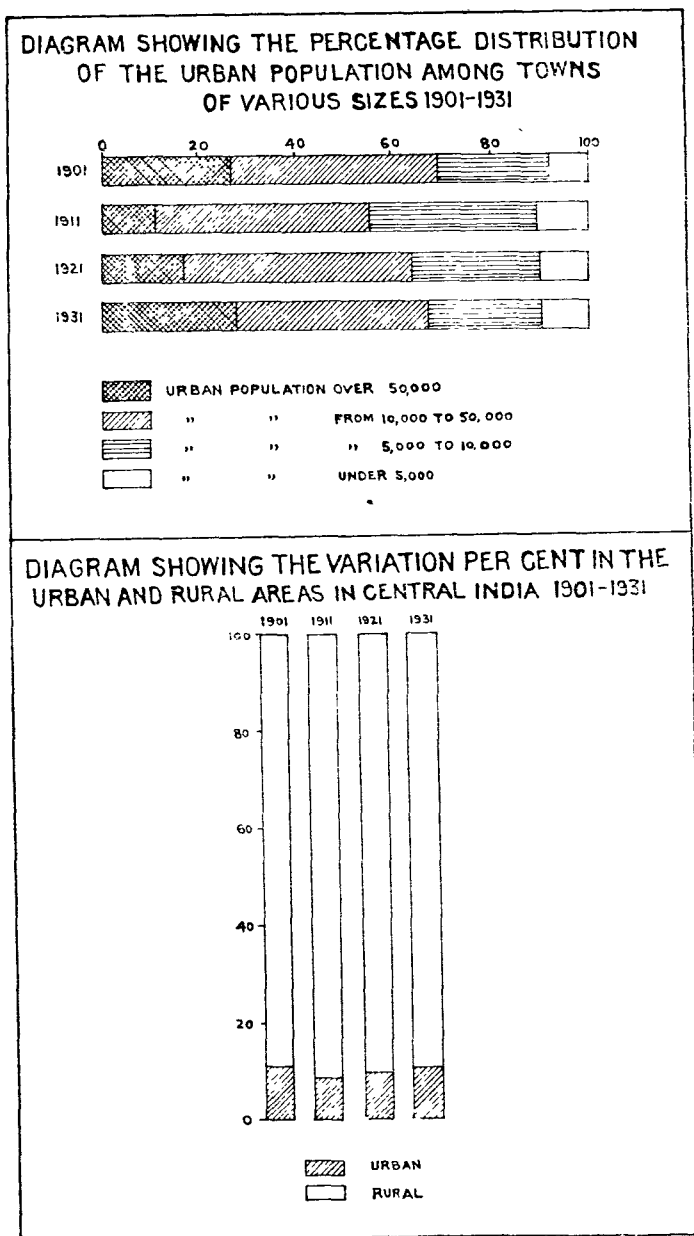

the general population. The rate at which the urban areas have increased in population is nearly 75 per cent. higher than that shown by the rural areas. Much of the increment cannot be attributed to any influx from the countryside to the urban areas. It is more due to the immigration to the cities whose population has been considerably augmented by the immigrants. The growth of the population has been poor in the towns belonging to class V.

58. Distribution of the Population between Urban and Rural areas.—

The marginal table gives the required information on this point. Though compared with 1901,

Urban and Rural Population.

Year.	POPULATION AS CONSTITUTED AT EACH CENSUS.			PROPORTION PER CENT TO TOTAL POPULATION.	
	Total.	Urban.	Rural.	Urban.	Rural.
1	2	3	4	5	6
1901 . .	5,435,038	608,824	4,826,214	11.2	88.8
1911 . .	6,133,764	508,325	5,625,439	8.3	91.7
1921 . .	6,002,551	550,854	5,451,697	9.2	90.8
1931 . .	6,632,790	677,670	5,955,120	10.2	89.8

the urban population shows a decrease yet in the last two decades it shows a steady rise and has increased by 2 per cent. since 1911, with a corresponding decrease in the rural population. The variation per cent. in the urban and rural population and the

percentage distribution of the urban population in places of various sizes are shown in the diagrams.

59. **Progressive and decaying towns.**—The marginal towns are progressive since 1901. The low figures for 1911 in some places are due to the plague epidemic at the time of the

Progressive Towns.

Town.	1901.	1911.	1921.	1931.
1	2	3	4	5
Indore . . .	86,686	44,947	93,091	127,327
Indore Residency . .	11,118	9,195	12,226	15,197
Khargone . . .	7,624	9,423	10,610	12,157
Sutna . . .	7,471	7,192	7,998	11,176
Barwani . . .	6,277	7,279	8,395	8,949
Tarana . . .	4,490	5,463	4,997	6,307

Census. In more than twenty towns the figures show some increase in the decade but compared with 1901, the progress is not at all well-marked. It is because the town is not in many places a very stable unit. It continues to throw off people and fails to attract from the rural parts to replenish its stock.

The figures for Chhatarpur and Tikamgarh shown in the margin are typical of this class. In Chhatarpur the increase in the decade is 163 and the

Town.	1901.	1911.	1921.	1931.
1	2	3	4	5
Chhatarpur . .	10,029	10,413	10,142	10,305
Tikamgarh . .	14,050	15,495	14,096	14,366

increase over the 1901 figures is 276. It is clear these towns have merely existed. They have not grown. Ten towns have decayed if we compare their population with that of 1901. Of these excluding the

Cantonments of Mhow and Nowgong whose variation is artificial, the eight named in the margin show increase during the decade though they are below their

Towns that have decayed since 1901.

Town.	1901.	1911.	1921.	1931.
1	2	3	4	5
Bhopal . . .	77,023	56,024	45,094	61,037
Jaora . . .	23,854	18,054	17,151	20,998
Datia . . .	24,071	17,329	15,221	18,292
Sehore . . .	16,864	12,105	13,588	13,860
Maharajagar . .	11,718	9,879	9,532	11,064
Panna . . .	11,346	10,756	10,106	10,913
Samthar . . .	8,286	7,441	6,447	6,966
Maheshwar . .	7,042	9,599	6,788	6,399

respective 1901 population. Maheshwar is the only instance of absolute decay. The figures for 1911 are abnormal owing to the influx of population due to plague. This town was the capital of Indore State for nearly a century. In 1820 when the capital was definitely shifted to Indore it had a population of 20,000 souls and was reported to be in a prosperous condition.

perous condition.

60. Sex proportion in Towns.—In column 4 of Subsidiary Table III will be found the number of females to 1,000 males in the different classes of towns in Central India. Considered for all the 56 towns there are 864 females to 1,000 males. The ratio is naturally lowest, 734 per mille, in class I which contains the large industrial City of Indore. It rises to 866 in class II containing the City of Bhopal which is a non-industrial capital town. The fall in class III is due to the presence of Mhow Cantonment and the City of Ratlam. In towns under 5,000, the sex-ratio is 962, which is practically the same as in rural areas (958). The increase in sex-ratio accompanies the decrease in the urban characteristics of the towns in the different classes.

61. Religion in Towns.—The great mass of the population who are Hindus live in the rural parts. The primitive tribes shun urban areas and they are more

Religion.	Number per mille who live in towns.
1	2
All religions	102
Christian	651
Muslim	475
Jain	363
Hindu	80
Tribal	7

at home in their jungle homes. Historical and political causes have deposited the Muslims in urban areas and the Jains who follow the path of trade naturally flourish where there are towns. These facts are apparent from Subsidiary Table II where the number per mille of the total population of each religion who live in town, is given by locality. The marginal figures extracted from there confirm the observation that the minorities crowd and get on in the

towns. The marginal table is reproduced from Chapter XI (Subsidiary Table IV)

Religious composition of urban population by Natural Divisions.

Natural Division.	NO. PER 10,000 OF URBAN POPULATION WHO ARE				
	Hindu.	Muslim.	Tribal.	Jain.	Christian.
1	2	3	4	5	6
Central India	6,907	2,639	37	269	101
West	6,519	2,935	45	328	124
East	8,104	1,725	10	87	29

to show the religious composition of the urban population. There are 69 Hindus, 26 Muslims, 3 Jains, 1 Christian, 1 Tribal and others, in every hundred of the population. The Hindus and the Jains form about three-fourths

of the urban population in Central India.

62. Village.—In the Code it was laid down that where there has been a recent Survey and the revenue village (or *gaon*) is a well-recognised unit with definite boundaries, it is clearly desirable to take this area as the Census village. Where no survey has taken place, the area ordinarily recognised for revenue purposes, must be adhered to for census purposes, all hamlets being included in the parent village. Care was taken to see that no hamlet was treated as a separate village. In the earlier Censuses, there was difficulty in obtaining correct village lists. The States are now alive to the need of possessing them and in the last two decades no difficulty has been experienced in obtaining accurate lists of villages from each unit.

Ordinarily a revenue village corresponds to the Census village. A rural village requires no detailed description. Their communal organisation and want of security in by-gone days have made the rural people gregarious, and hence they are concentrated together living closely under a common headman and cultivating the fields outside the residential area of their villages. The villages have well-marked boundaries. The Balai or the Kotwar or any other low caste person who does the work of the village watchman, knows the exact boundaries and before the revenue papers came into vogue, he was the authority concerning the village boundaries. The permanency of the village sites is proverbial and even when dispossessed in times of anarchy, the villagers returned with the restoration of normal condition and took possession of every house and field. The desolate village soon flourished as though nothing had happened. An exception to this permanency of village sites is provided by the curious practice reported from Rewa. There the village site at some definite intervals is shifted from place to

place, of course within a short radius. In the decade it is stated this custom has been stopped.

In the Vindhyan hills and jungles, the villages differ markedly from those in the plains. The Bhil does not like to have a neighbour. The Bhil huts are scattered about, one hut considerably apart from another. A Bhil *para* bearing a separate name is a Census village which sometimes runs into miles. In south Rewa, the Baiga lives in small forest clearings and a cluster of few Baiga huts in the dense jungle make up a village. The primitive tribes are not attached to the soil. They are being compelled in recent times to practise agriculture, perhaps, much against their natural inclination. From food gatherers they are forced to be food raisers. On the slightest pretext they shift their places and new habitations come into existence. As shifting cultivation is being abandoned, they tend to remain at one place. So long as they remain in the jungles, they have their restless spirit and energy which they forfeit as the price they have to pay for settling in the immobile environment of a settled village.

63. Distribution of rural population.—The total number of villages in the Agency is 23,252 and there is an increase of 1,462 villages since 1921. This increase is due to new habitation, to survey and settlement in many of the principal States, to a greater accuracy in the preparation of village lists, to the declaration of certain hamlets as Revenue *mauzas*, and to other causes. 59 per cent. of

Proximity of villages.

Division.	Mean distance between village in miles.
1	2
Central India Agency	1.6
Indore	1.7
Bhopal Agency	1.5
Bhopal	1.6
Malwa Agency	1.5
Southern Central India States Agency.	1.6
Bundelkhand Agency	1.8
Baghelkhand Agency	1.5
Rewa	1.5

the rural population live in villages under 500 and 35 per cent. in villages with population between 500 and 2,000. The remaining 6 per cent. live in villages between 2,000 and 5,000. The country is sparsely populated. Small villages prevail everywhere. The average population of a village varies from 140 in Khilchipur State to 442 in Chhatarpur State. If we assume that all parts of the Agency are compact and each village to be a point distributed all over the country, the average distance between each village is given in the margin. Owing to the larger-sized villages in Indore State and in the Bundelkhand Agency, the

mean distance is greater between them than in the other political divisions or in the States of Rewa and Bhopal if taken separately.

Cities.

64. General.—In this Agency there are three Cities, *viz.*, Indore, Bhopal and Ratlam. Only Indore conforms to the definition of a city as given in the

Variation in population of Cities.

City.	Popula- tion in 1931.	VARIATION PER CENT.		
		1921-31.	1911-21.	1891-31.
1	2	3	4	5
Indore	127,327	+36.8	+107.1	+53.4
Bhopal	61,037	+35.4	-19.8	-13.2
Ratlam	37,675	+25.0	+7.3	+26.3

Imperial Code. The other two are treated as cities for local purposes. Their population is shown in the margin and the proportionate changes of the population in the previous decades are illustrated graphically. The violent fluctuations in the figures for 1911 are due to plague which affected the cities very badly. Though the population

has increased markedly in all the three cities during the decade, Indore alone shows a progressive increase and is a rapidly growing and expanding place. It is because it has now become an industrial town attracting considerable immigrant population. The characteristics of these three cities are brought out in the marginal statement. The sex proportion is lowest in Indore and this is to be expected from an industrial town which attracts male immigrants. The ratio of foreign born is highest in Indore and very low in Bhopal. The high figures

PROPORTIONAL CHANGES IN THE POPULATION OF THE CITIES IN C.I. 1881-1931

AS SHOWN BY THE CURVES OF THE LOGS OF THE POPULATION.

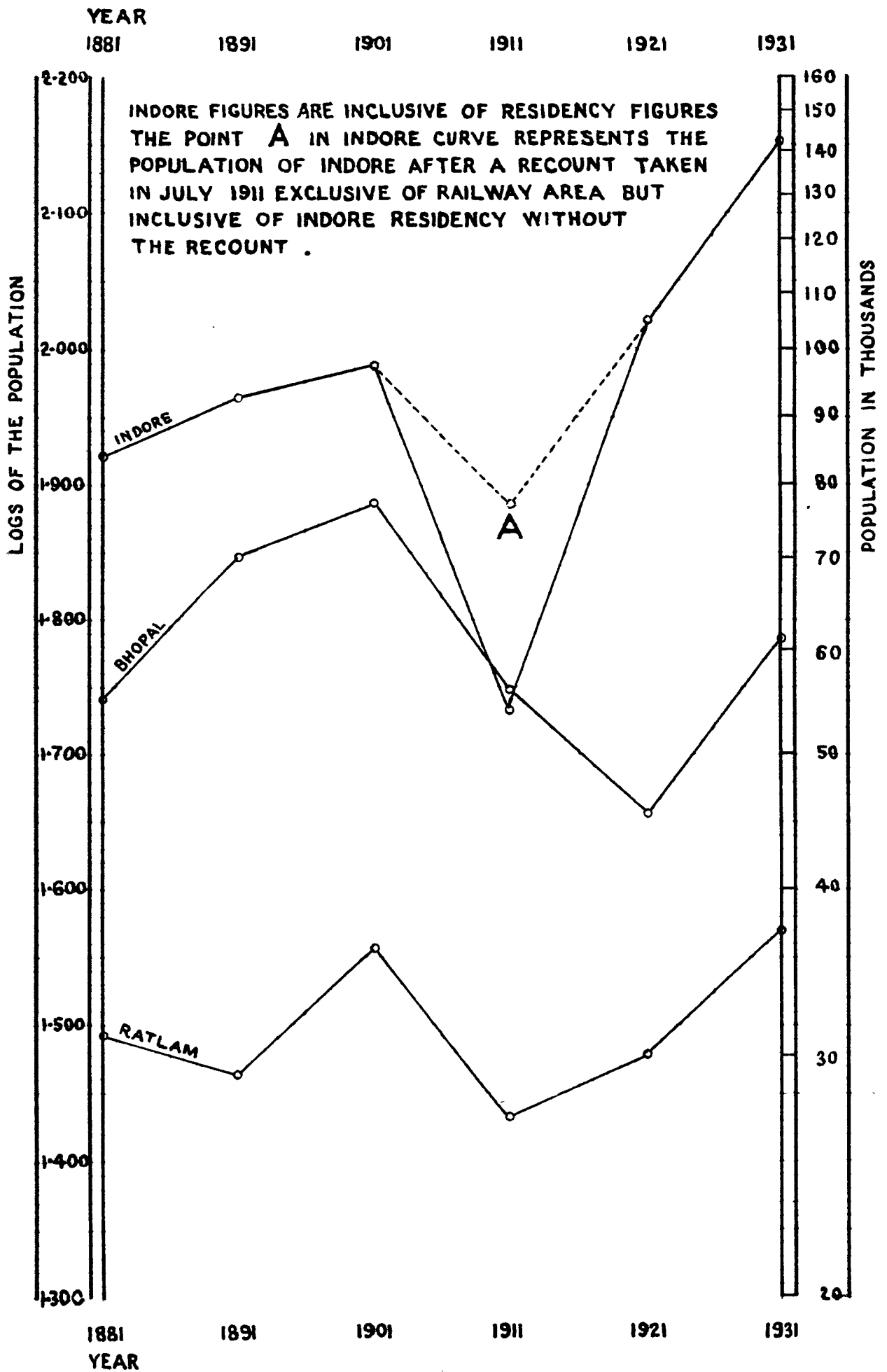

for Ratlam are artificial as it contains a large railway colony. In fact for the detailed study of city figures, Ratlam and Bhopal do not constitute real cities.

Proportion of females and foreign born in Cities.

City.	PROPORTION PER MILLE OF			
	Females to males.		Persons born outside the city of enumeration.	
	1931.	1921.	1931.	1921.
1	2	3	4	5
Indore . . .	734	765	560	526
Bhopal . . .	866	876	302	255
Ratlam . . .	867	874	482	Not available.

There is no other place in Central India which can claim a parallel development to that of Indore which for its rise and importance stands in a category by itself. Bhopal owes its position due to being the capital town of an important State situated on the main line of railway communication, while Ratlam owes its rise to its favourable situation at the junction of railway communications. These two local cities need not detain us any more. The rise

of Indore City and its passing into class I in the present Census, justifies a far more detailed treatment than was accorded to it in the previous Censuses.

The City of Indore.¹

65. Introductory.—The City of Indore can lay no claim to any antiquity. At the time of the conquest of Malwa by the Mahrattas it was a small and insignificant village (portions of which now form part of old Indore) but soon became a convenient halting place for armies that were passing to Hindustan and to the Deccan. In the time of Ahilya Bai Holkar it was made the head-quarters of Indore district and she raised it to a state of comparative prosperity though the capital remained at Maheshwar. The city suffered heavily at the hands of the contending armies of the Mahratta Chiefs in the early part of the last century. After the treaty of Mandasor it definitely became the capital of Indore State and with the location of the head-quarters of the Agent to the Governor General it assumed greater importance. In 1820, Sir John Malcolm estimated its population at 63,560 and to this must be added 20,000 more, representing the computed strength of the camp and court of the Ruler. For more than half a century the city followed the inevitable career of the capital town of a State, which was one of decay or at best, of a static existence. As the city came to assume modern conditions, the old-world elements began to decay and disappear and at first there was nothing to take their place. But two significant changes came over which affected the constitution of the city. One was the opening of Malwa by railway communication and the central position of Indore helped it to become a trading and distributing centre and the second was the industrialisation of the place. The change however worked slowly and it was not till 1905, a second cotton mill was started. The trading classes have followed in the wake of this development. The administration has always inspired confidence by its stability and by its helpful encouragement towards industrial developments. Favourable as these factors were, natural calamities in the past decades took a heavy toll of life and caused a serious set back to the natural growth of the population in the city. The ravages of plague from 1911 onwards and the serious Influenza epidemic brought about a great loss of life but these have been made good by the great volume of immigration in the last two decades and by the natural growth of the population which has taken place under the normal conditions of the intercensal decade. In the last 10 years the population of the city has increased by 36·8 per cent. It is now the twenty-ninth² city in India and has become an important centre for textile industry. Given favourable prospects, the city exhibits every tendency to grow.

66. Area, Population and Density.—The area of the city as given in Provincial Table I is 8·28 square miles and it has a population of 127,327 giving a density of 15,378 per square mile. This area is less than the area reported by the

¹ I am indebted to Mr. Surendra Nath Dube, M.A., Assistant Census Officer, Indore, for compiling all the tables in this Section.

² It is twenty-seventh City if we include, as we ought to, the Indore Residency area.

State. The discrepancy is not of much consequence as the area in a Municipal town is never correctly known and secondly the density figures calculated on the

INDORE CITY

SHOWING DENSITY OF THE POPULATION PER ACRE BY WARDS

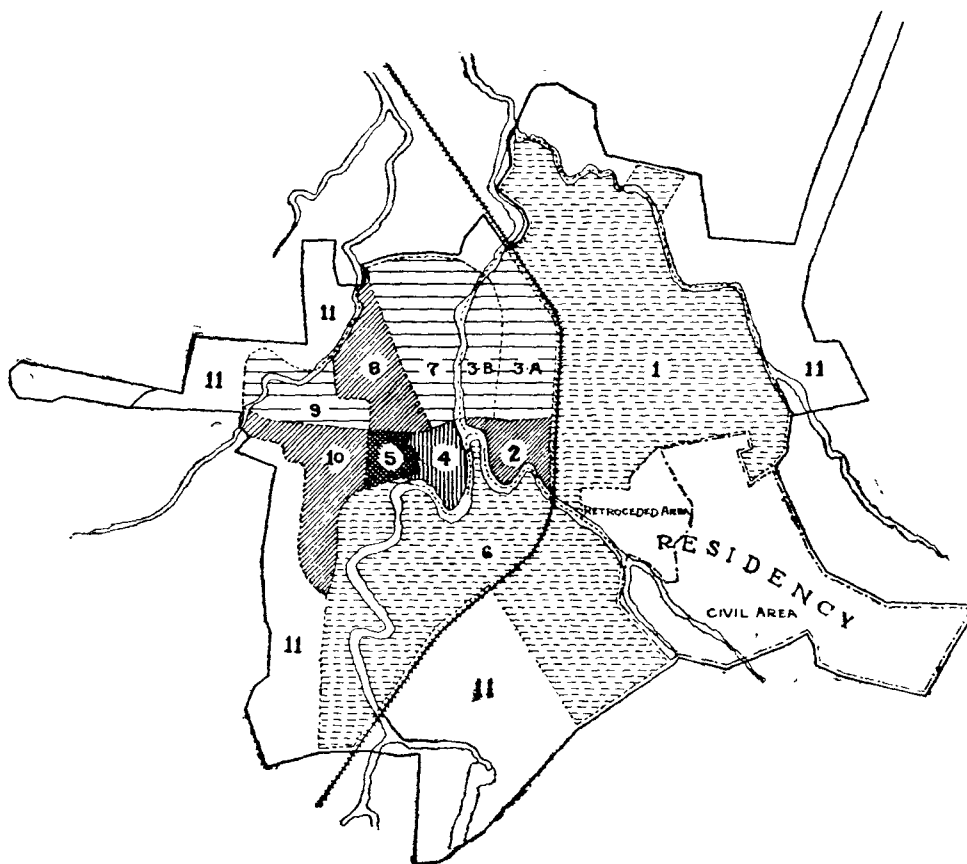

NOTE.

DENSITY IS NOT SHOWN IN THE MAP OF OTHER AREAS (WARD 11) OF THE CITY OF INDORE AND FOR THE RESIDENCY AREA

THE DOTTED LINE SHOWS THE APPROXIMATE PORTION OF THE RETROCEDED AREA.

REFERENCES.

INDORE CITY BOUNDARY	-----
INDORE RESIDENCY BOUNDARY	-----
INDORE CITY MUNICIPAL WARD NO.	----- 2
UNDER 10 TO 25 PER ACRE	----- [Dotted pattern]
" 25 TO 50 " "	----- [Horizontal lines]
" 50 TO 100 " "	----- [Diagonal lines]
" 100 TO 150 " "	----- [Vertical lines]
" 150 TO 186 " "	----- [Cross-hatch pattern]

total area are not very illuminating. A city like Indore has expanded with an overgrown village as its nucleus. The oldest parts are narrow and congested and the habitations are of mud and wattle interspersed with occasional *pacca* buildings. In between the habitations, there are in some places cultivated lands or private gardens. In other parts there are public thoroughfares and few broad roads. Then there are open spaces, polo and parade grounds and playing grounds attached to schools. One portion of the city is occupied by the industrial area. Modern extensions containing bungalows and open spaces and the extensive palace grounds are again spread over a considerable area. In order to obtain some measure of the uneven distribution of the city population the marginal table has been prepared showing the density per acre. The old portions of the city are naturally congested while one of the extensions, *viz.*, Ward No. 6, has a density of only 11 per acre. Ward No. 5 records the highest density

and there are 10,816 persons in a recorded area of 58 acres. Ward Nos. 2, 4, 5, 8, 9 and 10 occupy only one-twelfth the area but more than half the total population is crowded into them. A separate tenement census was not taken but from the information available it appears that overcrowding is not absent even in the new extensions round about the mill area. In some instances entire families are housed in single room tenements and it is not unusual to find a family of 6 or 7 lodged in a room of 10 feet by 10 feet or slightly larger. The housing problem especially in the mill areas is bound to force into prominence in the coming years and it would be interesting to know the state of affairs ten years hence.

Area, Population and Density of Indore City by Wards.

City and Ward.	Persons.	Males.	Fe- males.	Area in acres.	Density per acre.	Order in res- pect of den- sity.
1	2	3	4	5	6	7
Indore City	127,327	73,450	53,877	6,242	20	..
1	14,327	8,848	5,479	1,312	11	11
2	10,861	6,349	4,512	120	91	3
3A	8,886	5,390	3,496	220	40	8
3B	4,830	2,836	1,994	116	42	7
4	9,554	5,132	4,442	90	105	2
5	10,816	6,026	4,790	58	186	1
6	14,358	8,106	6,252	1,300	11	10
7	9,699	5,457	4,242	302	32	9
8	11,601	6,606	4,995	164	71	4
9	7,772	4,415	3,357	180	43	6
10	15,777	8,687	7,090	280	56	5
Other areas	7,524	4,490	3,034	2,100	4	12
Train and road enu- meration.	1,322	1,108	214

only one-twelfth the area but more than half the total population is crowded into them. A separate tenement census was not taken but from the information available it appears that overcrowding is not absent even in the new extensions round about the mill area. In some instances entire families are housed in single room tenements and it is not unusual to find a family of 6 or 7

lodged in a room of 10 feet by 10 feet or slightly larger. The housing problem especially in the mill areas is bound to force into prominence in the coming years and it would be interesting to know the state of affairs ten years hence.

67. **Immigration.**—The city has been attracting a large immigrant population during the last three decades. We have to discard the 1911 figures as the Census was taken during the time that plague was raging in the city. In 1921, the foreign-born constituted 52.6 per cent. of the population. Now the proportion of foreign-born is 56 per cent. In the table below will be found the States and Provinces which largely contribute in sending the immigrant population to the city, together with their religious composition and the proportion of females to 100 males by each religion.

Religious distribution of and Sex proportion in the population of Indore City.

Birth-place.	TOTAL.		HINDU.		MUSLIM.		JAIN.		CHRISTIAN.		OTHERS.		FEMALES TO 100 MALES.					
	Males.	Females.	Males.	Females.	Males.	Females.	Males.	Females.	Males.	Females.	Males.	Females.	Total.	Hindu.	Muslim.	Jain.	Christian.	Others.
1	1	3	4	5	6	7	8	9	10	11	12	13	14	15	16	17	18	19
TOTAL POPULATION.	73,450	53,877	55,793	40,644	14,528	11,046	1,833	2,552	187	115	390	239	73	73	76	82	61	61
Born in the City	30,344	25,663	21,126	17,954	8,275	6,895	801	708	43	19	99	87	85	85	83	88	44	96
Foreign born	43,106	28,214	34,567	22,690	6,253	4,151	1,751	1,125	144	96	291	152	64	66	66	64	77	52
Indore division	1,946	1,519	1,578	1,231	309	234	52	49	4	5	3	..	78	78	76	96	125	..
Other parts of the State.	3,326	2,253	2,579	1,761	571	365	175	122	1	1	..	4	68	68	64	69	100	..
Central India	4,459	3,527	3,310	2,640	888	733	219	134	6	4	36	16	79	80	83	61	67	44
Gwallor	5,740	4,512	4,444	3,494	953	741	328	264	1	4	14	9	79	79	78	80	400	64
Rajputana	10,312	6,369	8,630	5,225	1,069	785	599	342	10	3	4	14	62	61	73	57	30	350
United Provinces	8,200	3,740	7,021	3,176	1,043	499	120	44	13	14	3	7	46	44	48	37	108	233
Central Provinces	2,375	1,820	1,945	1,499	305	231	104	81	8	18	3	1	77	77	76	78	44	33
Bombay including Baroda and Western India Agency.	5,039	3,613	4,378	3,241	475	252	117	65	17	16	51	40	71	74	53	55	87	88
Other parts of India.	1,662	839	774	417	615	305	37	24	59	32	177	61	50	54	49	65	54	34
Outside India	47	22	8	6	24	6	15	10

The interesting facts that emerge from these figures can briefly be indicated. The immigrant population consists of a greater proportion of males and the bulk of them are Hindus and Jains. In the total population the proportion of females to 100 males is 73 while in the foreign-born it falls to 64. The main streams of migration are not from the adjacent parts of the State or even from other parts of Central India. They are chiefly from Rajputana and the United Provinces. The immigrants from the United Provinces to the city number one half of the total immigrants from those provinces to the State and the low sex-ratio of 46 shows that they do not bring their women with them. Immigrants from Rajputana have a sex-ratio of 62 which again is lower than the ratio for the total foreign-born. The population of the city has been augmented not from the countryside but from the distant provinces.

68. **Age.**—The effects of migration are seen in the age constitution of the city population. In the marginal table the age distribution of 10,000 of each sex in Central India by different age-periods is compared with that in the city. These figures show the remarkable deviation of the city figures from those of the general population: the excess of males at all ages from 15 to 50; the great deficiency of children of both the sexes; and the excess of females between the ages of 15 and 30. These disturbing effects are clearly due to migration of persons into the city. The lower child population in the city is due to the immigration of adults and also perhaps to a higher rate of infantile mortality in the urban area. The age distribution of the local- and foreign-born population in the three large categories are given in the table

Age distribution of 10,000 of each sex in Central India and in Indore City.

Age-period.	10,000 PERSONS DISTRIBUTED ACCORDING TO SEX AND AGE.			
	CENTRAL INDIA.		INDORE CITY.	
	Males.	Females.	Males.	Females.
1	2	3	4	5
0—5	1,433	1,586	993	1,384
5—10	1,323	1,276	934	1,060
10—15	1,245	1,148	988	1,051
15—20	944	946	1,150	1,144
20—25	950	980	1,280	1,217
25—30	891	885	1,113	928
30—35	780	763	943	731
35—40	638	632	717	603
40—45	547	530	577	513
45—50	425	391	437	413
50—55	324	308	340	333
55—60	201	213	207	227
60—65	161	181	170	201
65—70	57	63	57	70
70 and over	81	98	94	125

below. Crude age-periods have been taken for this table as information was readily available by those periods.

Age distribution by three main age-groups.

Population.	PROPORTION OF 1,000 OF THE CITY POPULATION IN THE AGE-PERIODS.					
	0—16		17—46		47 and over.	
	Males.	Females.	Males.	Females.	Males.	Females.
1	2	3	4	5	6	7
Total	325	384	560	493	114	123
Local-born	482	522	424	378	94	100
Foreign-born	215	259	656	596	129	145

Among the local-born only 40 per cent. are found in the period 17—46 and the corresponding proportion for foreign-born is over 62 per cent. Of the foreign-born males 66 per cent. are found in this age-period.

Sex-ratio by Wards in Indore City.

Ward.	Proportion of females to 1,000 males.
1	2
1	619
2	711
3A	649
3B	703
4	865
5	795
6	771
7	777
8	756
9	760
10	816

Proportion of females to 1,000 males in certain age-periods.

Population.	All ages.	0—16.	17—46.	47 & over.
1	2	3	4	5
Total population	733	867	645	792
Local-born	845	917	755	891
Foreign-born	655	786	594	739

69. **Sex.**—A lower sex-ratio is inevitable in a population which contains a large number of male immigrants. There are 734 females to 1,000 males and the variation by different wards is shown in the marginal table. Ward No. 1 includes the industrial area. There the proportion of females goes down to 619 per 1,000 males. If the foreign-born be considered, the sex-ratio is 655 and in the age-period 17—46 it is only 594. In the table these facts are clearly brought out.

70. **Occupation.**—The table in the margin gives the proportion of earners and working dependents per 10,000 of population.

Sex.	Earners and working dependents.
1	2
Total	4,310
Males	6,576
Females	1,220
City-born	3,187
Males	5,110
Females	914
Foreign-born	5,191
Males	7,607
Females	1,495

and working dependents per 10,000 of the total population. The workers form 43 per cent. of the population. The males have 66 per cent. workers and among the foreign-born the proportion is 76 per cent. The female workers among the foreign-born have a higher ratio than either the total or the local female workers. The number of workers among the foreign-born is about twice that of the local-born.

Occupational distribution of the population of Indore City with Sex-ratio.

Occupation.	EARNERS AND WORKING DEPENDENTS IN EACH OCCUPATION PER 10,000 OF TOTAL EARNERS AND WORKING DEPENDENTS.			FEMALES PER 1,000 MALES (EARNERS AND WORKING DEPENDENTS).		ACTUAL NUMBER OF WORKERS.			
	Total.	City-born.	Foreign-born.	City-born.	Foreign-born.	City-born.		Foreign-born.	
						Males.	Females.	Males.	Females.
1	2	3	4	5	6	7	8	9	10
All Occupations	10,000	10,000	10,000	151	120	15,504	2,345	32,791	4,228
I. Exploitation of animals and vegetation.	400	237	478	149	93	368	55	1,619	151
II. Exploitation of minerals.	7	3	9	1,000	103	3	3	29	3
III. Industry	3,615	3,317	3,759	129	145	5,243	677	12,158	1,758
5. Textiles	2,136	1,647	2,378	77	141	2,711	210	7,725	1,077
IV. Transport	299	242	326	59	35	408	24	1,169	39
V. Trade	1,463	1,895	1,255	192	111	2,836	546	4,182	463
VI. Public Force	697	691	700	1,233	..	2,590	..
VII. Public Administration	744	1,112	567	43	15	1,904	81	2,068	31
VIII. Professions and liberal arts.	485	552	452	198	92	823	163	1,534	141
45. Religion	85	116	71	67	57	195	13	247	14
46. Law	36	36	36	64	..	133	..
47. Medicine	68	93	55	383	273	120	46	161	44
48. Instruction	143	169	131	292	160	233	68	418	67
IX. Persons living on their income.	168	230	137	274	236	321	88	411	97
X. Domestic service	704	724	695	310	291	986	306	2,142	431
XI. Insufficiently described occupations.	1,113	751	1,288	314	254	1,020	321	3,801	966
Clerks, Accountants.	127	123	128	4	2	220	1	474	1
Labourers	925	582	1,091	441	313	720	318	3,074	963
XII. Unproductive	305	246	334	226	136	359	81	1,088	148
Beggars	193	171	204	269	205	241	65	626	123

The above table presents at a glance the occupations followed in the city and their distribution between the local-born and the foreign-born sections of the population. Industrial occupations support the largest number. The real strength of this occupation is probably understated by the inclusion of mill hands amongst the general labourers. About half the number of workers are absorbed in the two occupations of trade and industry. Other details can easily be understood from the table.

71. **Religion.**—The Hindus form 75 per cent. of the total population, Muslims 20 per cent., Jains 3 per cent. and the remaining 2 per cent. are represented by Christians, Sikhs, Tribals and others.

72. **Caste.**—Of the important castes, the Brahman forms 18 per cent. of

Ahir	3,271
Brahman	23,993
Dakshani	9,700
Bania	12,323
Chamar	6,279
Dhangar	3,626
Kachhi	1,197
Koli (Kori)	3,358
Mali	2,485
Maratha	5,459
Rajput	7,537
<i>Muslim.</i>	
Pathan	5,857
Sayyad	1,630
Sheikh	8,321

the population, the Bania forms 10 per cent., and the Ahir, Chamar, Dhangar, Maratha, Kori, Rajput, Pathan and Sheikh individually contribute more than 2 per cent. The Bania, Brahman, Chamar, Kori and Rajput castes contain a large number of immigrants. The strength of some of the principal castes is given in the marginal Table.

SUBSIDIARY TABLE I.

Distribution of the population between towns and villages.

Agency, Natural Divisions and States.	AVERAGE POPULATION PER		NO. PER MILLE RESIDING IN		NO. PER MILLE OF URBAN POPULATION RESIDING IN TOWNS WITH A POPULATION OF.				NO. PER MILLE OF RURAL POPULATION RESIDING IN VILLAGES WITH POPULATION OF			
	Town.	Village.	Town.	Village.	20,000 & Over.	10,000 to 20,000.	5,000 to 10,000.	Under 5,000.	5,000 & Over.	2,000 to 5,000.	500 to 2,000.	Under 500.
1	2	3	4	5	6	7	8	9	10	11	12	13
CENTRAL INDIA AGENCY	12,101	256	102	898	448	227	236	89	..	57	353	590
West	13,836	247	147	853	543	152	235	70	..	63	318	619
1. British Pargana of Manpur	..	221	..	1,000	341	..	659
2. Indore	21,128	297	176	824	682	118	180	20	..	86	351	563
<i>Bhopal Agency.</i>												
3. Bhopal	13,282	212	127	873	657	149	..	194	..	35	289	676
4. Khilchipur	5,779	140	127	873	1,000	200	800
5. Narsinghgarh	9,241	253	81	919	1,000	94	278	628
6. Rajgarh	6,617	180	98	902	1,000	20	238	742
<i>Malwa Agency.</i>												
7. Dewas States	9,478	259	185	815	..	591	244	165	353	647
8. Jaora	20,998	244	210	790	1,000	100	233	667
9. Ratlam	37,675	282	351	649	1,000	160	371	469
10. Sailana	5,669	200	161	835	1,000	316	684
11. Sitamau	6,303	235	222	778	1,000	322	678
<i>Southern Central India States Agency.</i>												
12. Ali-Rajpur	5,149	299	50	950	1,000	354	646
13. Barwani	6,295	335	134	866	744	256	..	48	413	539
14. Dhar	8,795	291	145	855	..	557	336	107	..	61	382	557
15. Jhabua	183	..	1,000	63	188	749
16. Jobat	330	..	1,000	106	313	581
East	8,723	265	53	947	152	459	242	147	..	51	389	560
<i>Bundelkhand Agency.</i>												
17. Ajaigarh	4,279	238	50	950	1,000	414	586
18. Baoni	368	..	1,000	130	296	574
19. Bijawar	5,748	325	50	950	1,000	57	506	437
20. Charkhari	11,064	282	92	908	..	1,000	22	513	465
21. Chhatarpur	6,296	442	156	844	..	409	477	114	..	132	515	353
22. Datia	11,620	292	146	854	..	787	..	213	..	81	394	525
23. Orchha	14,366	375	46	954	..	1,000	110	400	490
24. Panna	10,913	248	51	949	..	1,000	76	348	576
25. Samthar	6,966	303	209	791	1,000	502	498
<i>Baghelkhand Agency.</i>												
26. Baraundha	236	..	1,000	424	576
27. Kothi	277	..	1,000	544	456
28. Maihar	7,678	305	111	889	1,000	34	408	558
29. Nagod	4,259	199	114	886	1,000	365	635
30. Rewa	11,947	238	30	970	528	234	159	79	..	33	356	611
31. Sohawal	210	..	1,000	50	299	651
Rest of Central India Agency.	..	247	..	1,000	86	444	470

N. B.—Figures for Khaniadhana have been included in the East.

SUBSIDIARY TABLE II.

Number per mille of each main Religion who live in Towns.

Agency, Natural Divisions and States.	NUMBER PER MILLE WHO LIVE IN TOWNS.						
	Total population.	Hindu.	Muslim.	Tribal.	Jain.	Christian.	Others.
1	2	3	4	5	6	7	8
CENTRAL INDIA AGENCY	102	80	475	7	363	651	526
West	147	117	515	8	444	646	485
1. Indore	176	142	493	32	498	844	437
<i>Bhopal Agency.</i>							
2. Bhopal	127	73	537	4	295	865	542
3. Khilchipur	127	112	644	..	579	1,000	..
4. Narsinghgarh	81	72	279	..	115	1,000	794
5. Rajgarh	98	81	389	..	364	1,000	1,000
<i>Malwa Agency.</i>							
6. Dewas States	185	141	545	14	433	131	762
7. Jaora	210	112	678	29	529	654	900
8. Ratlam	351	386	805	5	791	980	902
9. Sailana	161	204	512	25	453	242	1,000
10. Sitamau	222	189	622	..	580	1,000	1,000
<i>Southern Central India States Agency.</i>							
11. Ali-Rajpur	50	36	594	81	595	80	1,000
12. Barwani	134	122	631	21	418	741	183
13. Dhar	145	129	455	6	361	819	523
East	58	45	387	..	116	733	731
<i>Bundelkhand Agency.</i>							
14. Ajaigarh	50	43	291	..	70	1,000	600
15. Bijawar	50	39	542	29	16	1,000	..
16. Charkhari	92	73	538	185	1,000
17. Chhatarpur	156	134	592	..	365	971	899
18. Datia	146	129	599	..	57	1,000	800
19. Orchha	46	35	381	11	115	680	1,000
20. Panna ^w	51	41	344	..	71	850	924
21. Samthar	209	189	466
<i>Baghelkhand Agency.</i>							
22. Maihar	111	94	653	..	630	857	293
23. Nagod	114	100	624	..	767	..	306
24. Rewa	30	26	220	1	433	683	441

N. B.—I. The figures for Khaniadhana have been included in the East

E

SUBSIDIARY TABLE III.

Towns classified by population.

Class of town.	No. of towns in each class in 1931.	Proportion to total urban population per mille.	No. of females per 1,000 males.	VARIATION PER CENT. IN POPULATION IN TOWNS AS CLASSIFIED AT PREVIOUS CENSUSES.				VARIATION PER CENT. IN URBAN POPULATION OF EACH CLASS FROM 1891 TO 1931.	
				1921 to 1931.	1911 to 1921.	1901 to 1911.	1891 to 1901.	(a) In towns as classified in 1891.	(b) In the total of each class in 1931 as compared with corresponding totals in 1891.
1	2	3	4	5	6	7	8	9	10
CENTRAL INDIA AGENCY	56	1,000	864	+23.0	+8.4	-16.6	+3.5	+15.2	..
1. 100,000 and over .	1	188	734	+100.0
2. 50,000 to 100,000 .	1	90	866	+36.8	-19.8	-38.2	+6.8	+22.9	-60.2
3. 20,000 to 50,000 .	4	170	812	+21.2	+36.4	-17.6	+7.6	-1.0	-14.5
4. 10,000 to 20,000 .	11	227	904	+13.7	-4.2	-16.5	-10.6	-14.6	-4.4
5. 5,000 to 10,000 .	24	236	921	+4.7	-9.5	+9.2	-11.6	-13.5	+50.4
6. Under 5,000 . .	15	89	962	+13.9	-10.7	-49.8	+100.0	+100.0	-5

SUBSIDIARY TABLE IV.

Cities.

City.	Population in 1931.	No. of persons per sq. mile.	No. of Females to 1,000 Males.	PROPORTION OF FOREIGN-BORN PER MILLE IN.		PERCENTAGE OF VARIATION.				
				1931.	1921.	1921-31.	1911-21.	1901-11.	1891-1901.	1891-1931.
1	2	3	4	5	6	7	8	9	10	11
Indore . .	127,327	14,147	734	560	526	+36.8	+107.1	-48.2	+4.5	+53.4
Bhopal . .	61,037	8,609	866	302	255	+35.4	-19.8	-27.0	+9.5	-13.2
Ratlam . .	37,675	37,675	867	482	not available.	+25.0	+7.3	-23.0	+21.8	+26.3

I The area of Indore City is 9.00 sq. miles.

II The area of Bhopal City is 7.09 sq. miles.

III The area of Ratlam City is 1.00 sq. miles.

I Foreign-born in Indore City	1931.	1921.
II Foreign-born in Bhopal City	71,320	48,987
III Foreign-born in Ratlam City	18,459	11,494
	18,175	not available.

APPENDIX TO CHAPTER II.

Indore Residency Area.

The Indore Residency Area is a British administered enclave adjacent to the city of Indore. In Imperial Tables IV and V it has always been shown as a separate town and the city figures are exclusive of those for the Residency. A few months after the Census was taken, a portion of the Residency area with a population of 10,807 persons was retroceded to Indore State. The area retained—designated as the Civil Area—has a population of 4,390. In the next Census the city of Indore should include the population of this Civil Area as well and Indore Residency as a separate unit should be merged into the city. As the transfer took place subsequent to the Census, it was decided to show separate figures for the Residency area. The following tables are appended giving certain details for the Residency area as it was before retrocession.

(A) Population of Indore Residency by Wards.

Census Circle No.	Name of Ward.	POPULATION.		
		Persons.	Males.	Females.
1	2	3	4	5
	Total Population	15,197	8,874	6,323
1	King Edward Memorial Hospital	649	376	273
2	Central India Agency Police Lines, Ratlam Kothi, Inspecting Officer I. S. Troops bungalow, Assistant Engineer's bungalow.	637	389	248
3	Mission bungalows and other houses including Canadian Mission Girls' High School.	519	190	329
4	Mission bungalows, Gwalior Boarding House and Medical Hostel.	380	293	87
5	Bhil Guard at Treasury, Treasury Office, Police Office, Petition-writers' Rooms, Press, Agent to the Governor General's Office, the Residency and out-houses.	362	226	136
6	Central India Agency Jail	311	255	56
7	Malwa Bhil Corps Lines	947	480	467
8	Daly College.	335	323	12
9	Thagi Jail, Water Works, Fruit and Vegetable Gardens, Plague Hospital, Bolearo Quarters and the Residency Club.	249	140	109
10	} Parsi Mohalla	2,446	1,332	1,114
11				
12	} Koriaganj Mohalla	2,389	1,377	1,012
13				
14	Kalali Mohalla	1,588	967	621
15	} Murai Mohalla	3,076	1,777	1,299
16				
17	Gwaltoli Mohalla	1,309	749	560

NOTE—Population statistics for the Civil Area are obtained by adding the figures for circles 1-9 and increasing the total by 1. The latter represents the population of the meat market included in the Civil Area.

(B) Birth-place Statistics.

There was no separate sorting for those born in the City and the Residency area. The figures were included in Indore Pargana.

Birth-place.	Persons.	Males.	Females.
1	2	3	4
TOTAL	15,197	8,874	6,323
1. Born in Indore Pargana (including City and Residency)	5,544	2,713	2,831
2. Born elsewhere	9,653	6,161	3,492

Classification of immigrants.

Birth-place.	Persons.	Males.	Females.	Birth-place.	Persons.	Males.	Females.
1	2	3	4	1	2	3	4
TOTAL	9,653	6,161	3,492	Portuguese Settlements	35	26	9
Indore State	684	300	384	India, unspecified	63	59	4
Other States in Central India.	2,061	1,291	770	Other Asiatic Countries	16	12	4
Other Provinces and States in India.	6,736	4,448	2,288	<i>Afghanistan</i>	4	3	1
<i>Gwalior</i>	1,631	1,148	483	<i>Arabia</i>	3	2	1
<i>United Provinces</i>	1,247	806	441	<i>China</i>	5	5	..
<i>Central Provinces and Berar.</i>	759	442	317	<i>Asia, unspecified</i>	4	2	2
<i>Bombay Presidency</i>	579	362	217	Non-Asiatic Countries	58	25	33
<i>Ajmer-Merwara</i>	106	61	45	<i>America</i>	18	5	13
<i>Rajputana Agency</i>	1,769	1,190	579	<i>Africa</i>	2	2	..
<i>Elsewhere</i>	645	439	206	<i>Europe</i>	38	18	20

(C) Main Caste Composition.

Caste, Tribe or Race.	Persons.	Caste, Tribe or Race.	Persons.
1	2	1	2
1. Ahir	223	9. Rajput	784
2. Bania (including Jain)	1,780	10. Minor Hindu Castes	1,588
3. Bhil	854	<i>Muslims.</i>	
4. Brahman	1,878	11. Pathan	748
5. Depressed Classes	874	12. Sayyad	396
6. Kayastha	253	13. Sheikh	1,060
7. Koli (Kori)	491	<i>Christians</i>	916
8. Maratha	358	<i>Zoroastrians</i>	202

CHAPTER III.

Birth-place and Migration.

73. Introductory.—The following instructions were printed on the Cover :—

Enter the District and State with administrative division where necessary in which each person was born ; and if the person was not born in your State add the name of the Province or the State to the district of birth, such as, Jhansi—United Provinces, Panch Mahal—Bombay Presidency, Narwar—Gwalior, Nemawar—Indore, or Ashta—Bhopal, or Dewas (Senior), Panna, Barwani, Rajgarh, etc. If the person was born out of India, enter the country, as, Nepal, Afghanistan, Ceylon. If any person was born in the cities of Indore, Bhopal and Ratlam and enumerated on the Census night there write the names of the cities as Indore City, Bhopal City, Ratlam City.

In the Abstraction Office instruction was given that in case column 13 was blank, the district of enumeration should be entered. The statistics relating to birth-place will be found in Imperial Table VI and the following Subsidiary Tables are embodied in the Chapter :—

I—Immigration (actual figures).

II—Emigration (actual figures). This is the complement of Table I.

III—Migration between Natural Divisions (actual figures) compared with 1921.

IV—Migration between the Province and other parts of India.

V—Immigrants by Sex and Religion.

Migration figures are of twofold use. They enable the natural growth of the population in the different parts to be ascertained and secondly they show the extent to which people move from one part of the country to another. Both in the printed and oral instructions the enumerating agency was cautioned not to enter the name of a village but still the enumeration books contained numerous such entries. Many of them were corrected in the Abstraction Office and those that baffled every diligent search have been shown as unspecified in the table. The unspecified entries are however small. Besides this inevitable source of error, migration statistics so far as this Agency is concerned, are incomplete. Owing to the restriction exercised in sorting for certain tables, few provinces did not sort for the birth-place figures for the Agency and others only supplied figures for the Agency as a whole. Consequently, emigration figures are not available either for the natural divisions or for the diverse units. As was pointed out in paragraph 529 of the Bombay Report for 1921, the direction to record the States in the Central India Agency becomes a difficult problem as the States are numerous and the term Central India Agency is not well-known. This normal difficulty has been conveniently overcome this time by not sorting for any of the units. From the United Provinces, complete figures have been made available and for few principal States from the Central Provinces. The results are that the information regarding the natural population in Chapter I is totally lacking, Subsidiary Table II in this Chapter is incomplete, and the proportion of sexes in the natural population by States in Chapter V is blank.

74. Types of migration.—Five types of migration are usually distinguished :—

(1) *Casual.*—Or the minor movements between adjacent villages. This type of migration only affects the figures when the villages in question happen to lie on opposite sides of a State or the Agency boundary. Females generally preponderate for a large number of short moves are due to marriage or due to the practice of a young married woman often going to her parents' home for her first confinement. In the Agency casual migration of this type is much the commonest class.

(2) *Temporary*.—Caused by pilgrimages, fairs and temporary employment on works. So far as fairs are concerned the Census date was chosen so as to avoid as far as possible a large assemblage at any place. The following are the places known to have an assemblage on the Census date :—

Fairs held on Census date.

State.	Locality.	Festival.	NUMBER ENUMERATED.		
			Persons.	Males.	Females.
1	2	3	4	5	6 j
Chhatarpur . . .	Khajuraho . . .	Fair at the temples . . .	1,358	1,109	249
Orchha	Tikamgarh . . .	Kundeshwar	1,310	1,014	296
Rewa	Deotalab	Shivratri	601	417	184
	Deoraj nagar . . .	Shivratri	52	37	15
Khilchipur . . .	Garahet	Cattle fair	414	287	127
Sailana	Sailana	Kalikamata	384	240	44
Sitamau	Sitamau	Holi-ka-hat	9	Not available.	

In all these places the males are in excess. They are mostly shop-keepers and others who were enumerated in the fair encampment.

(3) *Periodic*.—Due to migration for harvest work at stated seasons. Men ordinarily preponderate in this case. In Malwa during the wheat cutting season in March there is a movement of this kind but is not very pronounced. The Census was taken a short time before the movement usually begins.

(4) *Semi-permanent*.—The natives of one place reside and earn their living in another but retain their connection with their homes where they have their families to which they return in their old age or at stated intervals. This may be found in the city of Indore which is an industrial town and is also represented by some of the official and functionary classes in States which indent upon the neighbouring provinces. Otherwise the type is not common.

(5) *Permanent*.—This is caused by overcrowding or attraction to other districts. This is only met with in Central India as the result of the latter cause in places where better administration attracts cultivators from one State to another or bad administration has driven the people away.

Proportion of local and foreign born in some States and Agencies.

State or Agency.	NUMBER PER MILLE BORN	
	Within the Province.	Outside the Province.
1	2	3
Central India Agency . . .	909	91
Rajputana Agency	971	29
Gwalior State	920	80
Western India States Agency.	973	27
Mysore State	947	53

75. **Main figures.**—Of the total population of 6,632,790 enumerated in the Agency, 6,032,024 persons were born within Central India which gives a proportion of 909 per mille of the population. The proportion of the local and foreign born population for some of the States and the Agencies is shown in the table. The proportion of foreign born is much higher in Central India than in the adjoining State of Gwalior or the adjacent Rajputana Agency.

DIAGRAM SHOWING THE PERCENTAGES OF IMMIGRANTS
IN EACH NATURAL DIVISION OF THE
CENTRAL INDIA AGENCY

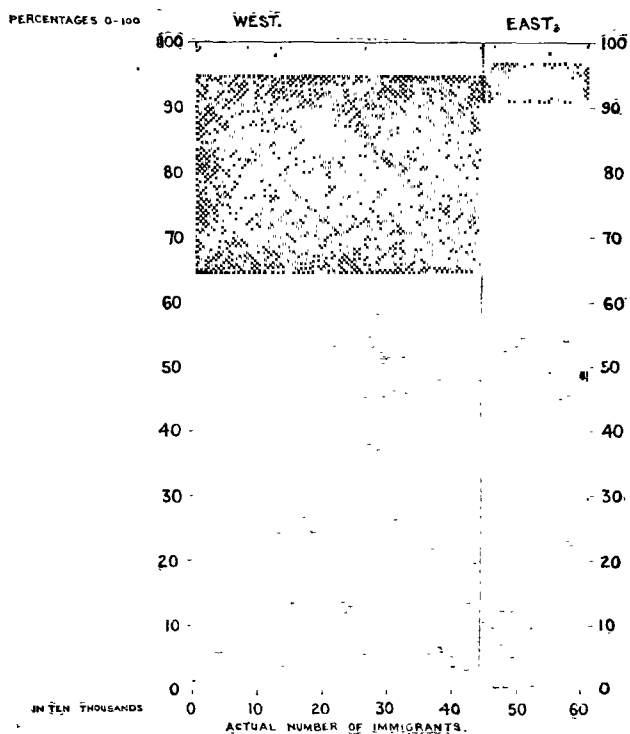

REFERENCES.

- IMMIGRANTS FROM OTHER PARTS OF CENTRAL INDIA:
 - " CONTIGUOUS DISTRICTS AND STATES ADJACENT TO C.I.
 - " NON-CONTIGUOUS DISTRICTS AND STATES ADJACENT TO C.I.
 - " OTHER PARTS OF INDIA.
 - " OUTSIDE INDIA.



Of the 91 per cent. born within Central India, 84.9 per cent. were born within

Born.	Proportion per mille of the actual population.	
1	2	
Within Central India		909
(a) Within States of Enumeration	849	
(b) Within contiguous parts of Central India.	55	
(c) Within Non-contiguous parts	5	
In contiguous parts of India		72
In other parts of India		18
Outside India	(less than)	1
		1,000

the States of enumeration, 5.5 per cent. within the contiguous parts of Central India and .5 per cent. in remoter parts. Of the immigrants enumerated within the Agency, 7.2 per cent. came from the contiguous provinces and 1.8 per cent. from the distant parts. Immigrants from outside India are a negligible quantity. 482,295 persons having their birth-place within the Agency were enumerated elsewhere. Of these 93.8 per cent. went to the contiguous parts of

other provinces, and 6.1 went to the more distant provinces. According to the information supplied by the Census Commissioner, 7 males were found outside India, 6 in Ceylon and 1 in Hongkong. Since 1921 the proportion of immigrants has remained practically unchanged but that of the emigrants has gone down from 81 to 72 per mille. This analysis of the main figures may be concluded by a

Local and foreign born population in 'principal States.

State.	NUMBER PER MILLE BORN.	
	Within the State.	Outside the State.
I	2	3
Indore	765	235
Bhopal	913	87
Rajgarh	789	211
Jaora	761	239
Ratlam	694	306
Dewas States	688	312
Barwani	859	141
Dhar	744	256
Chhatarpur	862	138
Datia	848	152
Orchha	921	79
Panna	854	146
Rewa	970	30
Nagod	803	197

consideration of the local and foreign born population in some of the principal States. The marginal figures are interesting in view of the interlaced nature of the State territories. The incompactness of the States is responsible for a large proportion of outside born shown against many of the States. The more compact the State is the less is the proportion of the foreign born. Barwani for example is more compact than many other contiguous States, but its boundary marches along the Bombay Presidency. Similarly, Bhopal is the most compact State in Western Central India. A great portion of Orchha is compact and it has a higher proportion of local born. The highest is in Rewa where 97 per cent. of the population is local born. It is also the most compact State in Central India.

76. **Extra Provincial migration.**—In Subsidiary Table IV absolute figures have been given both for the immigrant and emigrant populations by the Pro-

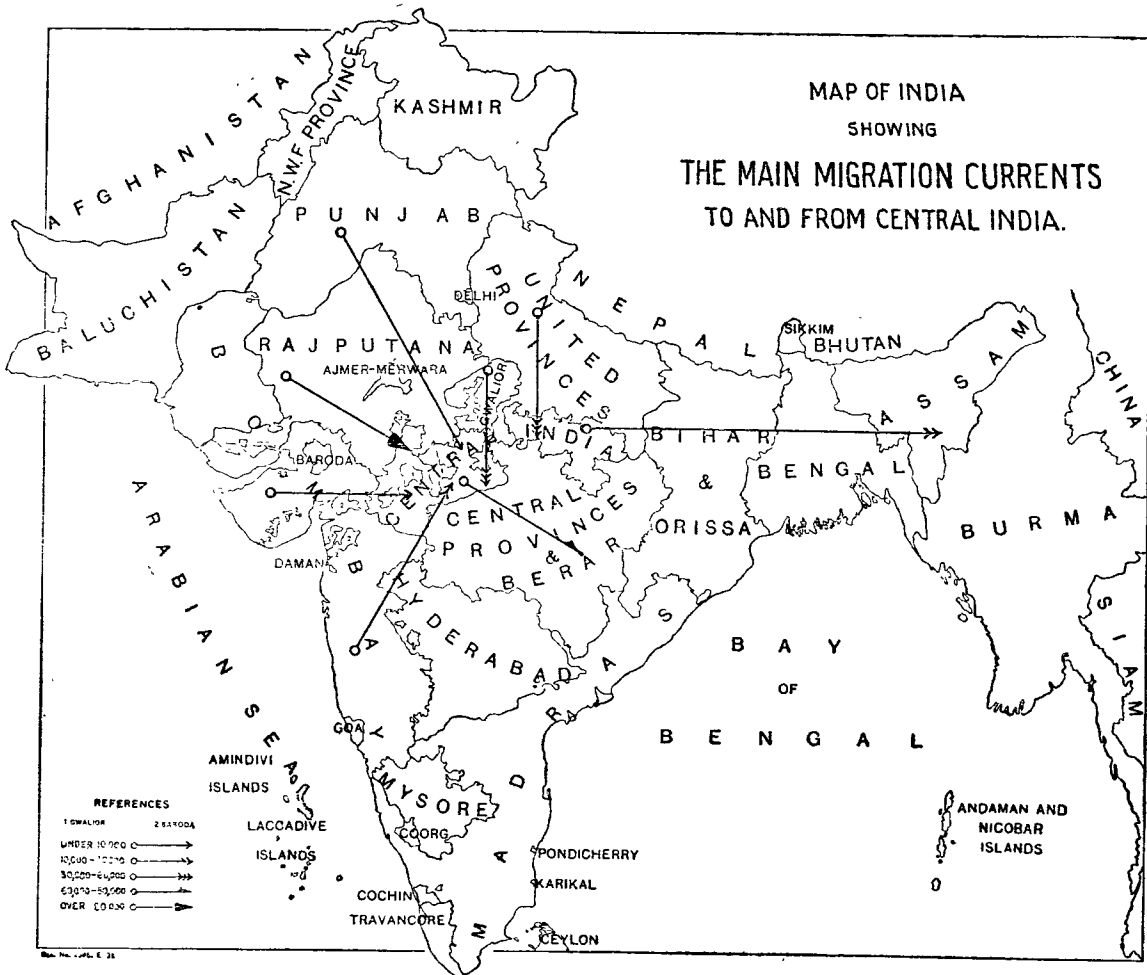

NOTE.—The arrows show the net result after deducting migration in the opposite direction. When the difference is less than 1,000 it has not been shown.

vinces and States in India. The direction of the migration currents affecting the constitution of the Agency population is shown in the map and the more

important figures are set down in the table. They practically cover the whole population of the migrants. Of those who have come from outside the Agency, Gwalior supplies 30.9 per cent., the United Provinces 24.3 per cent., Rajputana Agency 17.6 per cent., the Central Provinces 16.7 per cent. and Bombay 5.7 per cent. These five contiguous tracts thus account for 96.7 per cent. of the total immigrants. Each of the other parts contribute less than one per cent. The geographical position of Central India Agency is such that it is embedded in the very centre of India. The streams of immigration are not from one direction. They come from different directions according to the lie of the Agency territory in relation to the contiguous provinces. The total number of emigrants from Central India as far as it could be ascertained is put down at 482,294. Of this 22.6 per

Movement of population between Central India and other Provinces and States.

Province or State.	Immigra- tion to Central India.	Emigra- tion from Central India.
1	2	3
United Provinces	145,133	108,994
Central Provinces	100,067	176,802
Bombay	42,456	13,896
Ajmer-Merwara	4,326	2,439
Bihar and Orissa	985	2,075
Assam	32	14,887
Bengal	844	1,722
Punjab	5,352	331
Delhi	1,113	310
Gwalior	184,922	131,333
Rajputana Agency	105,405	26,335
Baroda	1,620	974
Hyderabad	1,321	558
Western India Agency	2,119	965

cent. were found in the United Provinces, 36.7 per cent. in the Central Provinces, 2.9 in Bombay, 5.5 in Rajputana, 27.2 in Gwalior and 3.1 in Assam. The remaining proportions are small and insignificant. Assam is the only province to which a long distance emigration takes place and this movement is the only exception

Variation in migration 1921-1931.

Province, Agency or State.	IMMIGRANTS TO CENTRAL INDIA.		EMIGRANTS FROM CENTRAL INDIA.	
	1931.	1921.	1931.	1921.
United Provinces	145,133	135,924	108,994	82,415
Central Provinces	100,067	85,701	176,802	194,259
Bombay	42,456	45,559	13,896	19,313
Assam	32	56	14,887	17,581
Gwalior	184,992	174,753	131,333	137,917
Rajputana Agency	105,405	85,899	26,335	25,176

to the general movement which is invariably from the contiguous parts bordering upon the Agency. The marginal table sets out the changes which have taken place in the streams of migration reaching Central India from the different sources. Both immigration and emigration have increased in volume in the direction of Rajputana and the United Provinces. Immigration from the Central Provinces has increased while emigration has fallen. Owing to the famine conditions in Rewa at the time of the 1921 Census, there was a considerable movement from that State to the adjoining districts of the Central Provinces. Both immigration and emigration from Bombay have decreased. The nature of the migration from Bombay is not quite clear. The Khandesh and the Panch Mahal districts of the Bombay Presidency march along the Agency border. The sex proportions show equality. It is possible that certain amount of migration is periodic into the cotton growing tracts of Nimar from Khandesh district. There is still considerable connection between the Maratha population in the Malwa States and the districts in the Deccan. Some migration may even be semi-permanent. No very definite information is however available on this point. Emigration to Assam has decreased during the decade. Though the details are unavailable, it is presumed that Rewa supplies the emigrants to Assam and that most of them are Kols. It is believed that the prevalence of *harwari* (a kind of agricultural serfdom) system operates in the direction of this long distance movement.

77. Rajputana.—The Rajputana States give 105,405 and take away 26,335. This is the largest contribution to the Agency which amounts to 79,070 persons. Of the Rajputana immigrants Indore absorbs 60,481 (57 per cent.), Ratlam 8,431 (8 per cent.), Dhar 5,686 (5 per cent.) and the remaining 30 per cent. are distributed over the different States in Western Central India. The Rajputana migrants are of two kinds if we can rely on the clue furnished by the sex proportions. In Indore, Dhar and Ratlam the males preponderate. Elsewhere the females are in excess. In the former the men come in quest of service in the cities of Indore and Ratlam and in the latter the migrants are usually the 'marriage migrants'. Emigration figures for Rajputana are not available.

78. **Gwalior.**—Migration between Gwalior and Central India States is somewhat artificial from the point of extra-provincial migration. Strictly speaking Gwalior migration cannot be held to be extra-provincial though administratively the State is independent and separate. Gwalior districts are inextricably mingled with the Malwa States and it is absurd to talk of migration where sometimes the movement does not extend beyond few miles. A person who goes

Migration between Gwalior and certain States of Central India.

State.	Immigrants from Gwalior.	Emigrants to Gwalior.	Districts of Gwalior sending immigrants to Central India.	Strength.
1	2	3	4	5
Indore	{ 69,601	{ 36,002	Ujjain	52,514
Bhopal	{ 17,271	{ 23,078	Shajapur	22,952
Dewas States	{ 18,192	{ 9,970	Mandasaur	19,554
Dhar	{ 16,557	{ 11,149	Gird Gwalior	16,438
Datia	{ 12,761	{ 12,859	Amjhera	12,695

out few miles from the Mhow Cantonment would soon find himself in Gwalior territory and if he continues ahead he will get into Indore State and before he realises where he is, he will be again in a Gwalior bit. The chief

contribution by and to Gwalior is given in the margin together with the principal districts from which the immigrants come. In either direction females preponderate and the migration is of casual type.

79. **United Provinces.**—The number of immigrants from the United Provinces is 145,133 and that of the emigrants is 108,994. This represents a gain of 36,139. 17 per cent. of the immigrants go to Indore. Orchha accounts for another 13 per cent., Charkhari and Rewa for 12 per cent. each, the minor States of Bundelkhand for 10 per cent. and Bhopal and Datia each for over 5 per cent. The highest proportion of immigrants goes to Indore and not to the adjoining Bundelkhand States. In the Section on the city of Indore we have already seen that

Migration with the United Provinces.

State.	Immigrants from United Provinces.	Emigrants to United Provinces.
1	2	3
Indore	23,577	1,258
Bhopal	7,316	1,969
Datia	8,370	9,394
Samthar	5,253	3,840
Charkhari	17,156	11,682
Orchha	19,263	31,422
Chhatarpur	6,371	10,555
Bundelkhand States. Minor	20,631	7,311
Baghelkhand States. Minor	8,084	1,127
Rewa	16,032	21,914

the city attracts a large number of immigrants from the United Provinces and that the females are in considerable defect. Migration to Indore and to a lesser extent to Bhopal is periodic and semi-permanent and the males here are twice as numerous as the females. In the Bundelkhand States the migration is of casual type as females greatly preponderate. The principal districts supplying the immigrants are Jhansi, Hamirpur and Banda. The Province gains from Orchha, Chhatarpur, Datia and Rewa but loses heavily in matrimonial exchange to the minor States and more permanently to the distant Indore and Bhopal.

80. **Assam and the Central Provinces.**—The Central Provinces and Assam are the two Provinces which gain by migration from Central India. The movement towards Assam as pointed out is unilateral and exceptional. The balance of emigration over immigration in favour of the Central Provinces is 76,735 and this amount of loss to the Agency is about the same as the gain from Rajputana. What the Agency gains from the West it loses in the East. Rewa alone contributes 48 per cent. of the emigrants to the Central Provinces. Bhopal gives 15 per cent. and Panna (12 per cent.) is another heavy loser. Indore sends out 15,535 and gains 36,661 immigrants. It is the only State that can claim a favourable balance from the Central Provinces. Out of the large contingent of 84,048 Rewa emigrants, Jubbulpore takes 26,857, and the Central Provinces States absorb 17,335 persons. Bilaspur and Mandla take between them another twenty thousand. Bhopal, Panna and Indore emigrants are mainly found in the districts adjacent to their respective States.

81. **Other movements.**—Migration with the five Provinces mentioned above accounts for 89 per cent. of the immigrants and 95 per cent. of the emigrants. The remaining 11 and 5 per cent. respectively of the immigrants and the emigrants are shared by the other Provinces and States. Bombay gives to Central India 42,456 persons and takes away only 13,896 thereby contributing 28,560 to the

gain of the Agency. The Punjab and Delhi together supply 6,465 immigrants but receive only 641 persons leaving a balance of 5,824 in favour of the Agency. Ajmer-Merwara accounts for 4,326 immigrants and 2,439 emigrants giving away 1,887 more than it receives. Baroda, Hyderabad and the Western India Agency respectively give 646, 763 and 1,154 more than they receive from Central India. The number of emigrants to Bihar and Orissa which is adjacent to a portion of Rewa State exceeds that of the immigrants from that Province by 1,090. Except in the Bombay figures which show the sex proportion to be practically equal, the males generally exceed the females, and the movement appears to be due to quest of service and also to exigencies of business. The movement with other distant parts such as, North-West Frontier Province, Baluchistan, Andamans and Nicobars, is insignificant. The emigrants to the Andamans and Nicobars represent prisoners transported there. The immigrants from Baluchistan and North-West Frontier Province should be identified with the Biloch and Afghan workmen and pedlars whilst some of them are the military employees in the State forces.

2,664 persons born outside India have been enumerated in the Agency. They are practically confined to the Western Central India and represent the British troops at Mhow Cantonment and Officers and Missionaries in the different parts of the Agency.

82. Religion of the migrants.—The religious distribution of the migrants may briefly be considered. Such information is not available in respect of the emigrants. For the immigrants it has been specially collected in this Census from the compilation Registers. The absolute figures for the Agency and by

Religious distribution of immigrants and Sex proportion.

Religions.	DISTRIBUTION PER 1,000 OF		FEMALES TO 1,000 MALES.		Proportion of immigrants per 1,000 of total religious strength.
	Immigrants.	Total Population.	Immigrants.	Total Population.	
1	2	3	4	5	6
Hindu . . .	859	882	1,475	949	88
Muslim . . .	91	57	808	899	145
Tribal . . .	21	51	1,250	989	38
Jain . . .	17	7	1,095	887	199
Christian . . .	8	2	536	752	481
Others . . .	4	1	677	816	391

individual States are exhibited in Subsidiary Table V appended to this chapter. The marginal table sets out for the Agency as a whole certain proportional figures which will be found interesting. The immigrant population consists of 86 per cent. Hindus, 9 per cent. Muslims, 2 per cent. Tribals, less than 2 per cent. Jains and over 1 per cent. Christian and other religions. A comparison of the religious composition of the immigrant with that of the general population shows that the proportion of the Christians and other minor religions among the immigrants is 4 times as large as that in the general population, of the Jains nearly $2\frac{1}{2}$ times as large, and of the Muslims over $1\frac{1}{2}$ times as large. The proportion of the Hindus is nearly equal and that of the Tribals less than a half. Another way of gauging the relative volume of immigration among the different religions is by considering the ratio which the immigrants in each religion bear to its total strength. Considered thus the different religions stand in the same order, the Christians and minor religions coming first followed in succession by Jains, Muslims, Hindus and Tribals. The greatest proportion of immigrants among the Christians and minor religions is natural as a large number of them are outsiders. The commercial nature of their occupation is apparently responsible for the Jains taking the first place among the principal religions. The Muslims being urban dwellers and engaged in a greater proportion in public services and professions show a higher proportion of immigrants than the Hindus. Tribals by nature are non-migratory and the figures in their case usually represent short distance movement from neighbouring places and are also, to some extent, affected by the inclusion of the figures for certain wandering and criminal tribes, such as the Nat, Banjara and Kanjar, who have been returned as Tribal from some States. The sex ratio among the immigrants is in favour of the females among Hindus, Tribals and Jains and in favour of the males among the remaining religions. The excess of females among the Hindus is 48 per cent., among the Tribals 25 per cent., and among the Jains

nearly 10 per cent. The greatest defect of females is among the Christian immigrants about 46 per cent. while the Muslims show a defect of about 19 per cent. The excess of females indicates that the immigration is largely due to matrimonial relationship whilst their defect points to the migration of men in search of employment or business. That the males and females do not migrate in the same proportion in all religions is apparent from the sex ratio of the immigrants which differs considerably from that of the total population in different religions. The Hindus show about 55 per cent. greater proportion of females among the immigrants than in the total population, the Tribals about 26 per cent. and the Jains 23 per cent. The corresponding figure for the Muslim immigrants who show a defect, is about 11 per cent.

83. **Balance of movements.**—We may now strike a balance of our gains and losses. The balance of movement is in favour of the Agency which receives 600,766 persons and gives away 482,295, leaving on the credit side 118,471 persons. Compared with the previous decade, this gain has doubled itself for the corresponding gain 10 years ago was 59,637.

84. **Inter-provincial immigration.**—In the absence of complete emigration figures, we cannot study fully the inter-provincial migration and it is not possible to know the gain or loss due to migration in the different States. Confining to immigration figures only, it may be interesting to notice the proportion of immigrants to the total population of some of the principal States. The relevant figures are given in the table and the proportion of immigrants is illustrated in the map. The figures in column 3 against the two Natural Divisions

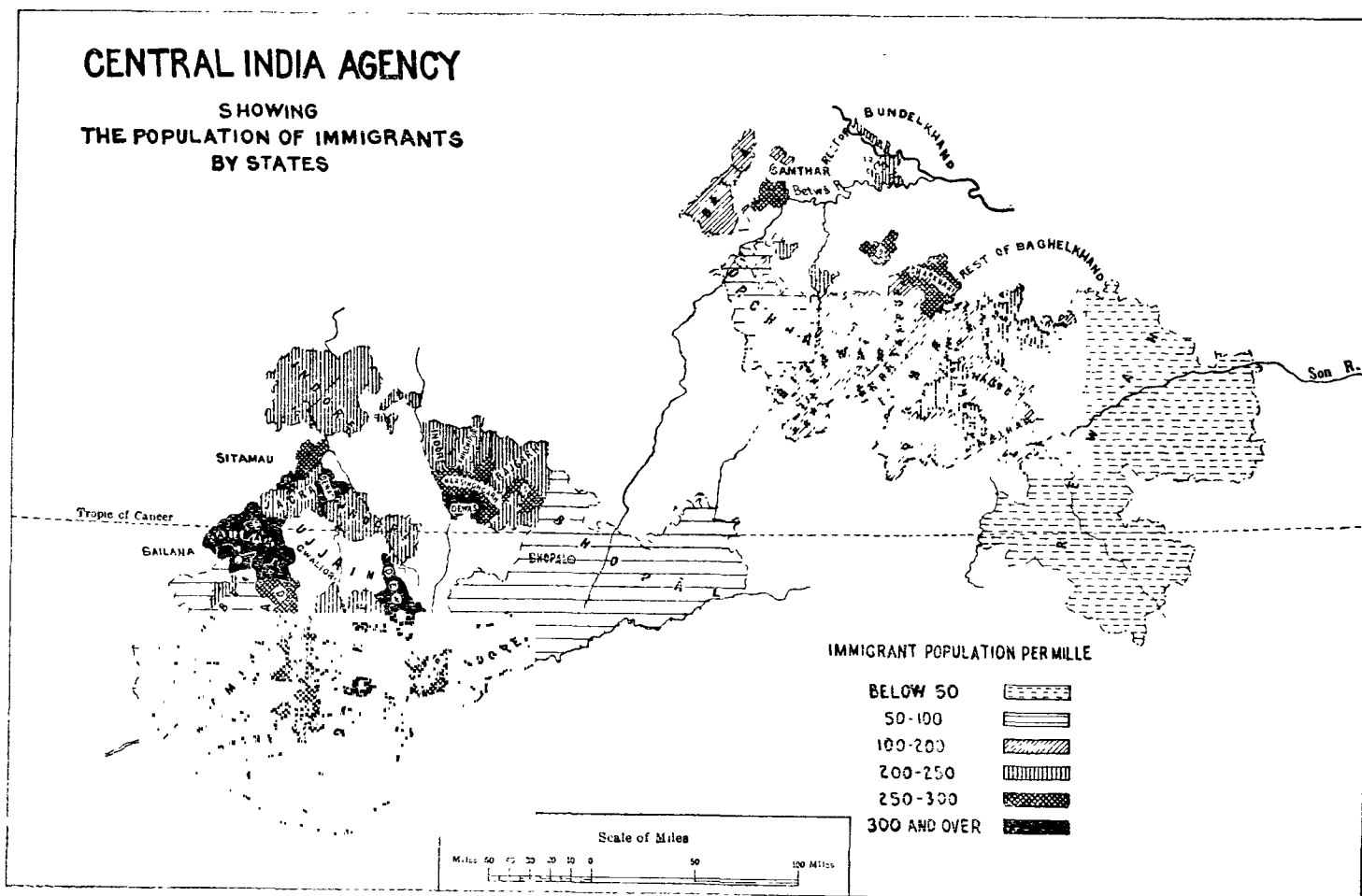

show the very small amount of inter-migration between the two Natural Divisions. The figures in column 2 show that wherever the States are interlaced with the other Central India States the proportion of migrants from the contiguous parts of Central India is high. Sailana and Ratlam, Rajgarh and Narsinghgarh, Dewas States, Ajaigarh, Dhar, Nagod and Maihar are instances of this nature. From column 3 it is clear there is very little movement from one part of Central India to another. Ordinarily there is a good deal of

disinclination for the subjects of one State to go and settle in another. The political nature of the boundary in the case of the Bundelkhand States like

Proportion of immigrants in some principal States.

Natural Division and State.	IMMIGRANTS PER MILLE OF POPULATION.			
	From contiguous parts in Central India.	From other parts in Central India.	From contiguous parts of other provinces.	From non-contiguous parts of other provinces.
1	2	3	4	5
Central India West	2	82	42
" " East	1	48	4
Sailana	211	12	75	34
Narsinghgarh	179	1	65	28
Ajaigarh	170	7	29	4
Nagod	159	11	18	9
Dewas States	135	17	128	32
Rajgarh	122	1	72	16
Dhar	126	13	76	41
Maihar	111	16	52	10
Charkhari	95	12	133	11
Chhatarpur	80	10	30	18
Indore	62	2	104	65
Barwani	50	2	60	29
Ali-Rajpur	20	3	26	7
Datia	10	6	128	8
Orchha	10	3	60	6
Bhopal	9	3	56	19
Rewa	7	1	17	5

Samthar, Datia, Orchha and Charkhari, facilitates a freer movement to and from the contiguous parts of the United Provinces. The higher proportion in some of the Malwa States is due to the movement from Gwalior whose southern districts are really the contiguous parts of Central India rather than the contiguous parts of another province. Only Indore draws a large proportion from outside and also from the more distant parts. Excepting the city of Indore and to a much

smaller extent Ratlam, real migration does not take place. The oscillations of the migratory movements are mostly of the casual type and there are at present no signs of economic forces setting in motion movements of persons even from one part of the Agency to another.

SUBSIDIARY TABLE I.
Immigration. (Actual figures.)

Agency, Natural Divisions and States where enumerated.	BORN IN																	
	AGENCY, NATURAL DIVISIONS AND STATES WHERE ENUMERATED.			CONTIGUOUS PARTS OF CENTRAL INDIA.			OTHER PARTS OF CENTRAL INDIA.			CONTIGUOUS PARTS OF OTHER PROVINCES, ETC.,			NON-CONTIGUOUS PARTS OF OTHER PROVINCES, ETC.			OUTSIDE INDIA.		
	Persons.	Males.	Females.	Persons.	Males.	Females.	Persons.	Males.	Females.	Persons.	Males.	Females.	Persons.	Males.	Females.	Persons.	Males.	Females.
CENTRAL INDIA AGENCY.	6,032,024	3,152,773	2,879,251	475,457	175,933	299,524	122,645	74,627	48,018	2,664	2,105	
West	3,042,900	1,600,114	1,442,786	6,835	3,265	3,570	286,470	114,267	172,203	143,152	87,603	60,549	2,492	1,981	
British Pargana of Manpur.	4,482	2,430	2,052	1,380	620	760	237	120	117	305	151	154	438	258	180	10	3	
Indore	1,008,246	541,088	467,158	81,257	33,916	47,341	3,127	1,726	1,401	137,482	58,655	78,827	86,108	52,630	33,478	2,017	1,640	
Bhopal Agency.																		
Bhopal	666,174	350,532	315,642	6,761	2,470	4,291	2,265	1,161	1,104	40,829	14,737	26,092	13,766	8,946	4,820	160	115	
Khilchipur	35,751	20,947	14,804	6,066	1,842	4,224	232	82	150	2,380	731	1,649	1,152	463	689	2	2	
Narsinghgarh	82,779	47,888	34,891	20,417	7,249	13,168	151	66	85	7,395	2,701	4,694	3,130	1,640	1,481	1	1	
Rajgarh	106,361	60,286	46,075	16,463	5,868	10,595	104	41	63	9,765	3,789	5,976	2,195	1,191	1,004	3	1	
Malwa Agency.																		
Dewas States	105,768	60,743	45,025	20,786	7,336	13,450	2,658	1,055	1,603	19,684	6,906	12,688	4,910	2,560	2,350	28	25	
Jaora	76,268	43,043	33,225	9,639	3,259	6,380	1,006	181	825	9,167	2,935	6,232	4,062	2,150	1,912	24	14	
Ratlam	74,496	39,557	34,939	11,720	4,854	6,866	1,408	651	757	9,606	3,962	5,644	9,993	5,986	4,007	98	76	
Sallana	23,543	13,165	10,378	7,422	2,973	4,449	403	160	243	2,645	1,007	1,638	1,208	644	564	2	1	
Sitamau	21,033	12,470	8,563	2,550	688	1,862	273	111	162	3,327	939	2,388	1,237	505	732	2	2	
Southern Central India States Agency.																		
All-Rajpur	96,192	50,255	45,937	2,040	747	1,293	325	135	190	2,649	828	1,821	721	352	369	36	25	
Barwani	121,179	62,175	50,004	7,092	2,878	4,214	256	139	117	8,505	3,905	4,600	4,051	2,358	1,693	27	21	
Dhar	181,067	96,037	85,030	30,702	12,964	17,738	3,057	1,484	1,573	18,509	7,525	10,984	10,053	5,732	4,321	42	33	
Jhabua	133,848	69,355	64,493	4,753	1,824	2,929	320	140	180	5,072	1,924	3,148	1,516	879	637	13	7	
Jobat	16,793	9,037	7,756	2,137	702	1,435	593	236	357	400	159	241	210	118	92	19	14	
East	2,980,608	1,548,883	1,431,725	1,681	511	1,170	150,317	41,533	108,784	13,163	7,157	6,006	172	124	
Bundelkhand Agency.																		
Ajaigarh	67,838	38,354	29,484	14,595	4,660	9,935	624	213	411	2,467	815	1,652	360	178	101	2	..	
Baoni	15,012	8,660	6,352	249	80	169	3,655	1,105	2,550	216	64	152	
Bijawar	100,793	57,381	43,409	12,762	2,487	10,275	148	29	119	1,315	244	1,071	834	189	645	
Charkhari	90,167	53,720	36,447	11,417	3,070	8,347	1,396	345	1,051	16,021	4,474	11,547	1,341	472	860	9	5	
Chhatarpur	139,060	77,014	62,046	12,535	3,387	9,148	1,534	542	992	4,905	1,400	3,505	2,880	1,451	1,429	53	38	
Datia	134,614	78,191	56,423	1,567	230	1,337	959	329	630	20,337	3,939	16,398	1,357	819	588	
Orchha	289,797	158,052	131,745	2,959	627	2,332	1,061	263	798	18,999	3,780	15,219	1,830	538	1,292	15	12	
Panna	181,083	99,414	81,669	20,181	5,696	14,485	790	252	538	8,774	2,281	6,493	1,287	480	807	15	10	
Samthar	24,141	14,654	9,487	940	245	695	1,353	575	778	6,656	1,736	4,920	217	97	120	
Baghelkhand Agency.																		
Baraundha	13,414	7,587	5,827	587	258	329	434	140	294	1,570	419	1,151	66	39	27	
Kothi	16,296	9,230	7,066	3,726	1,130	2,596	769	209	560	359	143	216	274	54	220	
Maihar	55,932	30,141	25,791	7,659	2,323	5,336	1,137	371	766	3,562	873	2,689	609	393	306	2	..	
Nagod	59,887	32,695	27,192	11,843	3,611	8,232	844	275	569	1,816	204	1,112	697	304	393	2	2	
Rewa	1,539,338	776,590	762,748	11,172	3,214	7,958	2,135	1,077	1,058	26,723	10,399	16,324	8,001	4,046	3,955	76	55	
Sohawal	30,436	17,495	12,941	10,201	2,891	7,310	555	162	393	471	133	338	528	256	272	1	1	

NOTE.—Figures for Khanladhana have been included in the East.

SUBSIDIARY TABLE II.
Emigration. (Actual figures.)

Agency, Natural Divisions and States where enumerated.	ENUMERATED IN																	
	AGENCY, NATURAL DIVISIONS AND STATES WHERE BORN.			CONTIGUOUS PARTS OF CENTRAL INDIA.			OTHER PARTS OF CENTRAL INDIA.			CONTIGUOUS PARTS OF OTHER PROVINCES, ETC.			NON-CONTIGUOUS PARTS OF OTHER PROVINCES, ETC.			OUTSIDE INDIA.		
	Persons.	Males.	Females.	Persons.	Males.	Females.	Persons.	Males.	Females.	Persons.	Males.	Females.	Persons.	Males.	Females.	Persons.	Males.	Females.
CENTRAL INDIA AGENCY.	6,032,024	3,152,773	2,879,251	452,832	188,696	264,136	29,456	15,719	13,737	6	6	
West	3,042,900	1,600,114	1,442,786	1,681	511	1,170	
British Pargana of Manpur.	4,482	2,430	2,052	1,641	723	918	558	179	379	
Indore	1,008,246	541,088	467,158	58,204	21,941	36,263	1,315	555	760	
Bhopal Agency.																		
Bhopal	666,174	350,532	315,642	15,898	6,470	9,428	2,616	1,056	1,560	
Khilchipur	35,751	20,947	14,804	5,892	1,886	4,006	175	50	125	
Narsinghgarh	82,779	47,888	34,891	16,506	5,495	11,011	98	44	54	
Rajgarh	106,361	60,286	46,075	17,700	6,269	11,440	92	42	50	
Malwa Agency.																		
Dewas States	105,768	60,743	45,025	17,749	6,150	11,299	2,063	910	1,133	
Jaora	76,268	43,043	33,225	9,238	3,429	5,809	1,891	1,833	3,053	
Ratlam	74,496	39,557	34,939	10,332	4,158	6,174	1,157	474	683	
Sallana	23,543	13,165	10,378	6,431	2,506	3,925	371	149	222	
Sitamau	21,033	12,470	8,563	2,463	1,048	1,415	595	267	328	
Southern Central India States Agency.																		
All-Rajpur	96,192	50,255	45,937	7,795	3,571	4,224	1,687	806	881	
Barwani	121,179	62,175	50,004	19,952	9,555	10,397	460	197	263	
Dhar	181,067	96,037	85,030	24,469	9,806	14,663	2,408	956	1,452	
Jhabua	133,848	69,355	64,493	11,506	5,095	6,411	708	136	572	
Jobat	16,793	9,037	7,756	1,145	377	768	520	251	269	
East	2,980,608	1,548,883	1,431,725	6,835	3,265	3,570	
Bundelkhand Agency.																		
Ajaigarh	67,838	38,354	29,484	10,106	3,084	7,022	2,166	760	1,406	
Baoni	15,012	8,660	6,352	114	61	53	
Bijawar	100,793	57,381	43,409	15,222	3,725	11,497	1,247	573	674	
Charkhari	90,167	53,720	36,447	7,900	1,914	5,986	2,723	945	1,778	

SUBSIDIARY TABLE III.

Migration between Natural Divisions (actual figures) compared with 1921.

Natural division in which born.		NUMBER ENUMERATED IN NATURAL DIVISIONS (000's OMITTED).	
		West.	East.
1		2	3
West	1931	3,043	2
	1921	2,686	3
East	1931	7	2,981
	1921	4	2,756

NOTE.—Figures for Khaniadhana have been included in the East.

SUBSIDIARY TABLE IV.

Migration by Sex between Central India and other parts of India.

Province or State.	IMMIGRANTS TO CENTRAL INDIA.			EMIGRANTS FROM CENTRAL INDIA.		
	Persons.	Males.	Females.	Persons.	Males.	Females.
1	2	3	4	5	6	7
TOTAL	598,102	250,560	347,542	492,288	204,415	277,873
British Territory	294,127	122,624	171,503	320,123	140,535	179,588
United Provinces of Agra and Oudh	144,679	55,598	89,081	108,791	36,773	72,018
Central Provinces and Berar	98,166	38,610	59,556	176,802	84,780	92,022
Bombay	37,783	19,518	18,265	12,396	6,532	5,814
Ajmer-Merwara	4,326	2,543	1,783	2,439	1,177	1,262
Punjab	4,630	3,512	1,118	331	185	146
North-West Frontier Province	533	455	78	280	275	5
Assam	32	18	14	14,887	8,258	6,629
Bihar and Orissa	953	460	493	1,902	1,182	720
Bengal	844	509	335	1,722	971	751
Madras	715	380	335
Baluchistan	162	117	45	56	35	21
Burma	50	24	26	153	107	46
Andamans and Nicobars	4	3	1	54	39	15
Delhi	1,113	762	351	310	171	139
Coorg	1	..	1
India, unspecified	136	115	21
Indian States	303,615	127,714	175,901	162,165	63,880	98,285
Gwalior	184,922	67,369	117,553	131,333	52,053	79,280
Baroda	1,620	817	803	974	513	461
Hyderabad	1,321	751	570	558	293	265
Mysore	265	155	110	110	79	31
Kashmir and Jammu	160	128	32	11	8	3
Travancore
Rajputana Agency	105,405	53,772	51,633	26,335	9,629	16,706
Western India Agency	2,119	1,339	780	965	599	366
Bombay States	4,673	1,729	2,944	1,502	568	934
U. P. States	454	308	146	203	50	153
C. P. States	1,901	863	1,038
Punjab States	722	449	273
Bihar and Orissa States	32	15	17	173	88	85
Bengal States
Madras States	21	19	2	1	..	1
French and Portuguese Settlements	360	222	138

NOTE.—7 persons born in Central India were enumerated outside India, 6 in Ceylon and 1 in Hongkong.

CHAPTER IV.

Age.

85. **The Basis of the figures.**—In the last Census the enumerator was told to enter the number of years which each person had completed on the 18th March 1921 and to record the word 'infant' for children under one year. The instructions given on the Cover this time were a departure from the previous practices. They ran as follows:—

Column 7 (Age)—Enter the number of years to nearest birth-day or the nearest age in years known. For infants less than six months old, enter '0' and for infants over six months enter '1'. Do not enter months.

At the outset, it is necessary to know the nature of the change involved in recording the age in this Census. The age recorded in the previous Censuses was the completed number of years. The actuarial examination of the last age statistics showed that the method of asking age at the last birth-day or the next birth-day was attended with disadvantages and in practice, whatever may be the nature of the instructions, the age recorded by the enumerator was the nearest age. In this Census therefore the population was asked to return their ages nearest their birth-days. Thus the age of a person 15 years and 7 months would in 1921 have been shown as 15 whereas this time it would go in as 16. Similarly children

Number of group.	Group according to nearest age.	Corresponding limits to exact age.
1	2	3
1	0	Over 0 and under $\frac{1}{2}$
2	1	" $\frac{1}{2}$ " " $1\frac{1}{2}$
3	2	" $1\frac{1}{2}$ " " $2\frac{1}{2}$
4	3	" $2\frac{1}{2}$ " " $3\frac{1}{2}$
5	4 to 6	" $3\frac{1}{2}$ " " $6\frac{1}{2}$
6	7 to 13	" $6\frac{1}{2}$ " " $13\frac{1}{2}$
7	14 to 16	" $13\frac{1}{2}$ " " $16\frac{1}{2}$
8	17 to 23	" $16\frac{1}{2}$ " " $23\frac{1}{2}$
9	24 to 26	" $23\frac{1}{2}$ " " $26\frac{1}{2}$
10	27 to 33	" $26\frac{1}{2}$ " " $33\frac{1}{2}$
11	34 to 36	" $33\frac{1}{2}$ " " $36\frac{1}{2}$
12	37 to 43	" $36\frac{1}{2}$ " " $43\frac{1}{2}$
13	44 to 46	" $43\frac{1}{2}$ " " $46\frac{1}{2}$
14	47 to 53	" $46\frac{1}{2}$ " " $53\frac{1}{2}$
15	54 to 56	" $53\frac{1}{2}$ " " $56\frac{1}{2}$
16	57 to 63	" $56\frac{1}{2}$ " " $63\frac{1}{2}$
17	64 to 66	" $63\frac{1}{2}$ " " $66\frac{1}{2}$
18	67 to 73	" $66\frac{1}{2}$ " " $73\frac{1}{2}$
19	74 and over.	" $73\frac{1}{2}$

under 6 months would be shown as 0 and as 1 between 6 and 18 months. The new system of grouping is consequently based on nearest ages and the groups after age three, are formed so that ages which are odd multiples of 5 come in the middle of ternary groups 4 to 6, 14 to 16, etc., while ages which are multiples of 10 come in the middle of septenary groups 7 to 13, 17-23, etc. The age periods actually returned were $0-\frac{1}{2}$, $\frac{1}{2}-1\frac{1}{2}$, $1\frac{1}{2}-2\frac{1}{2}$ and so on. The number of groups is exactly same as was adopted in 1921. The marginal table sets down the position clearly.

This arrangement gave us to start with, ternary and septenary groups such as 0-3, 4-6, 7-13, 14-16, 17-23 and so on. The process of redistribution of these groups in ordinary quinary groups, namely, over 5 and under 10, over 10 and under 15 and so on, was not difficult for all that we had to do was to add exactly half of the number recorded in each group to half of the number recorded in the next succeeding group. The sum of these two halves will in each case represent the number in each of the quinary groups. In a similar way the number aged under 1 full year was taken to be those recorded as of nearest age 0, *i.e.*, under 6 months, added to half of those between 6 and 18 months. The number aged 1 and 2 years and that aged 2 and 3 were similarly treated. The number between 3 and 4 was taken to be half of those between $2\frac{1}{2}$ and $3\frac{1}{2}$ added to $\frac{1}{6}$ of those between $3\frac{1}{2}$ and $6\frac{1}{2}$. The number between 4 and 5 was taken to be $\frac{1}{3}$ of those in the ternary group $3\frac{1}{2}$ and $6\frac{1}{2}$. Imperial table VII has thus been prepared first into ternary and septenary groupings and adjusted as described above into quinary groups. The age table for 1931 nearly corresponds to the age definition of 1921 but it represents a reasonably accurate record over that of the previous enumeration.

86. Statistical reference.—The distribution of population by age, sex and civil condition is given in Imperial Table VII and of selected castes in Imperial Table VIII. The following Subsidiary Tables will be found at the end of the Chapter—

- I.—Age distribution of 10,000 of each Sex in the Province and each Natural Division (Table II of 1921).
- II.—Age distribution of 10,000 of each Sex in each main Religion (Table III of 1921).
- III.—Age distribution of 1,000 of each Sex in certain Castes (Table IV of 1921).
- IV.—Proportion of children under 14 and of persons over 43 to those aged 14-43 in certain castes ; also of married females aged 14-43 per 100 females.
- V.—Proportion of children under 10 and of persons over 50 to those aged 15-40 also of married females aged 15-40 per 100 females.
- V-A.—Proportion of children under 10 and of persons over 60 to those aged 15-40 in certain Religions ; also of married females aged 15-40 per 100 females.

Subsidiary Tables VI-X have been omitted owing to the absence of the necessary information. In the States of this Agency there is no registration of vital statistics of any kind. The absence of this useful material severely restricts the scope of this chapter and makes any elaborate discussion of Census statistics unreal. Neither does the nature of the age statistics justify any detailed treatment at the hands of an amateur. The Agency figures are not usually subjected to actuarial research and no life tables are constructed and birth and death rates deduced from the recorded crude data. This chapter therefore will not contain anything more than a bare analysis of few figures.

87. Inaccuracies of the Age returns.—Sufficient has been written in the previous reports regarding the inaccuracies in the Census age returns. People rarely know their correct ages and for Census purposes they have to be guessed. In the upper classes, few people now-a-days do keep some kind of age-record of their family. The Hindus have the custom of casting horoscopes but they are never produced before the enumerator. A horoscope may not often show the true age. It is easily recast to suit one's needs especially of a matrimonial nature and at times it is re-edited when lowering of age is required while seeking Government service. It is not any injunction such as that amongst other things age should be kept a secret which deters people from giving out their correct ages. The vast majority are both indifferent and ignorant towards the question. Ignorance is natural in a population which is illiterate and which never keeps any document. Indifference arises from the outlook on life. The average man or woman in India matures early and is short lived. Life presses heavily on them and fatalism overpowers them. Childhood, adolescence, middle life and old age, are well-marked stages in life and the Hindu social system has laid down conduct of life and has prescribed rules for the observance of customs and practices. It matters not if the precise age is not known. Apart from any question of reticence, the villager will stare at what he deems an irrelevant enquiry when you ask him to state his age ; will hesitate ; will sometimes ask " Is it my age " ; and when pressed will return some absurd answer especially if he is over 45 or 50. So the age recorded in the Census is the one guessed either by the enumerated or the enumerator. If our enumerator is somewhat conscientious he would ask a person when he took to the plough or how old he was when the great famine of 1899 broke out. He may in such cases approach to a nearer approximation. By far the heaviest burden that falls on the enumerator is to guess the age of practically everyone in his block. In the tribal areas, it is a matter of great difficulty to make the tribes return any age at all for many of them are not used to counting. A local event such as a Raja's marriage or installation was usually a serviceable guide to the enumerator in fixing the age according to his judgment.

The sources of inaccuracy in the age returns are consequently very wide. The various inaccuracies are reflected in the Census Schedules and one of the important forms taken is the preference for certain figures, *viz.*, those numbers ending in 0 and 5. According to actuarial research, the age of adults when based on guesses, no matter whether the age is asked according to last, nearest or next birth-day, results in preference for numbers ending in the digits shown in the order, *viz.*, 0, 5, 2, 8, 4, 6, 3, 7, 1, 9. This obsession for certain numbers is mental and psychological. Inaccuracies are also due to understatement or overstate-

ment in certain periods of life and they are principally due to the peculiarities of Indian social conditions. This time the instructions regarding the infants were precise. The word infant was altogether discarded. Children under 6 months were to be entered as 0. Still many people must have told their enumerator they have such and such a “*bachcha*” in the house, and their ages must have been guessed at and heaped in a wrong category. One way to gauge the effect of this kind of inaccuracy is to study the distribution by single years of the ages of children under 5 years. This is done in the table below:—

Statement showing the distribution by annual age-periods of the population aged 0—5 for main Religions.

Age.	ALL RELIGIONS.				HINDU (BRAHMANIC).				MUSLIM.				TRIBAL.			
	1931.		1921.		1931.		1921.		1931.		1921.		1931.		1921.	
	No. of persons.	Per cent.	No. of persons.	Per cent.	No. of persons.	Per cent.	No. of persons.	Per cent.	No. of persons.	Per cent.	No. of persons.	Per cent.	No. of persons.	Per cent.	No. of persons.	Per cent.
1	2	3	4	5	6	7	8	9	10	11	12	13	14	15	16	17
TOTAL 0—5 .	999,700	100	745,602	100	873,081	100	635,091	100	54,994	100	40,019	100	62,834	100	64,474	100
0 . . .	183,146	18	136,802	18	160,702	18	117,397	18	10,181	18	8,242	21	10,434	16	9,921	15
1 . . .	195,576	20	110,033	15	170,252	20	93,061	15	11,109	20	6,412	16	12,443	20	9,569	15
2 . . .	209,970	21	143,263	19	183,061	21	121,645	19	11,460	21	8,077	20	13,690	22	12,349	19
3 . . .	211,657	21	179,734	24	185,061	21	153,023	24	11,361	21	8,787	22	13,557	22	16,605	20
4 . . .	199,351	20	175,720	24	174,005	20	149,965	24	10,883	20	8,501	21	12,710	20	16,030	25

If correct ages were returned, the largest number of children should be found under one year and the number should decrease as we proceed from one year to another. But the figures disclose a state of affairs quite the contrary. The inaccuracy is more apparent among the Tribals in the case of children below one year. The effect of the new instructions in recording the age of infant is also seen in the table. In 1921 the proportion against the age-period 1 was the lowest in all the religions as well as in each of the main religions. This was due to the fact that most of the children who were of 1-2 age-period were put in under 0 age and few under the period 2-3. This time the figures against the age-period 1 are higher than the preceding one. Notwithstanding clear instructions, these inaccuracies became unavoidable but the method of grouping adopted is far more accurate than on the previous occasion. In youth, amongst females there is understatement if girls are not married before puberty. The family is tainted with disgrace and social obloquy if the girl attains puberty before she is married. In such cases the age of the girl is always understated. This affects the age-period 10-15. When the girl becomes mother, the tendency is to overstate the age. Motherhood confers upon her an authority and position in the family and there is a consciousness in her that as the mother of a number of children she is more aged than she actually is, for status goes with increasing age. In the case of males, the period of 15-20 is affected by the curious tendency to slur over it. Amongst the upper classes the inclination is to put a boy into a lower age; there is always the parental pride the boy is shaping well in school or otherwise though young in age. When marriage considerations come in, and if desired alliances are secured, the age is in few instances advanced to show the boy is sufficiently matured, though it must be pointed in general the tendency is to lower the age even for boys in matters of matrimony. Anyhow this awkward category is usually avoided. In the middle life men are prone to understate their ages. Apart from the necessities of matrimony in the case of bachelors and widowers, men do not like the idea of getting advanced in years and they feel they are younger still. They go in for a lower than a higher age in this period of life.

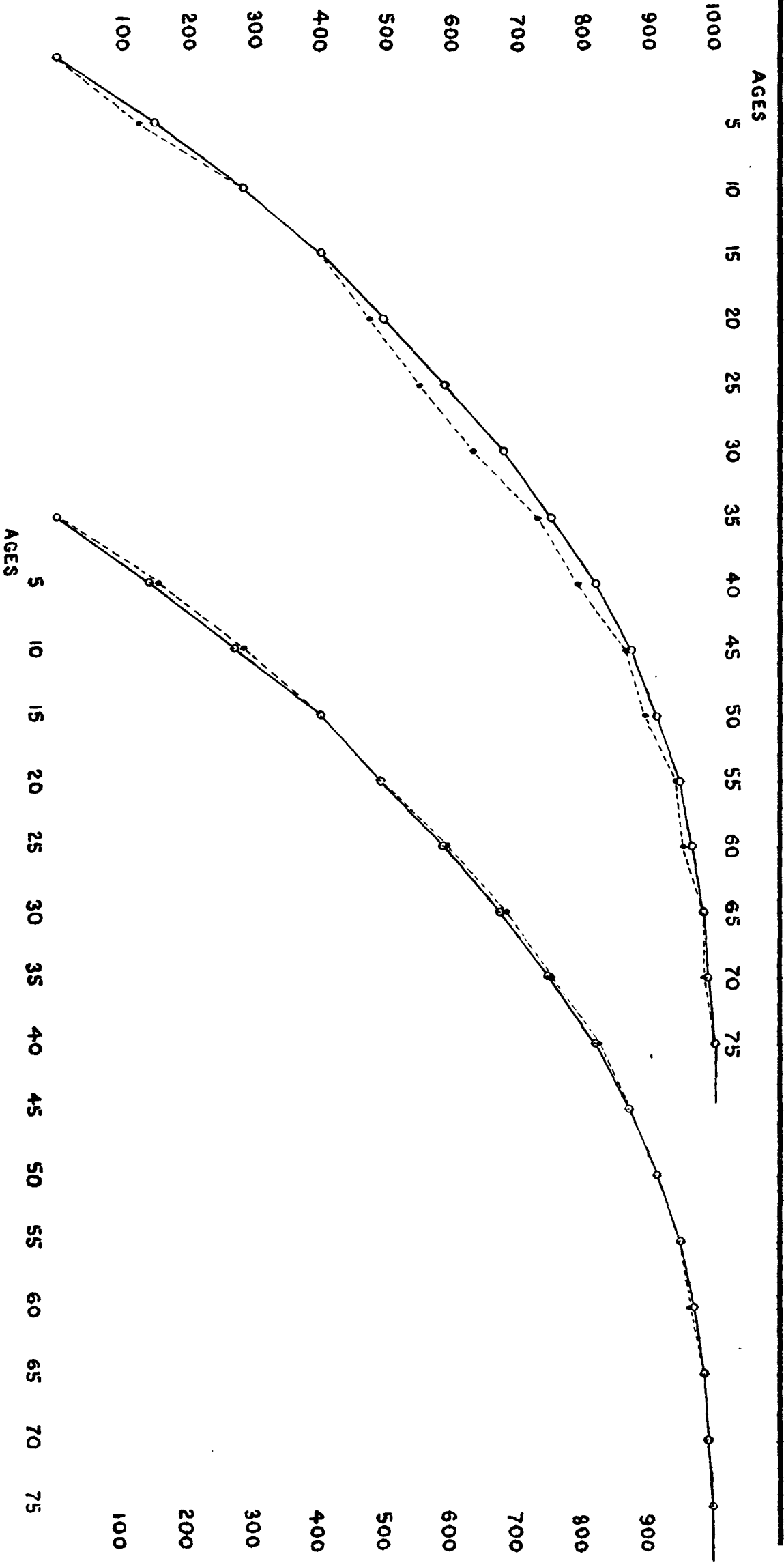

CUMULATIVE CURVE OF THE AGE - DISTRIBUTION OF EVERY THOUSAND OF THE POPULATION IN CENTRAL INDIA , 1931 & 1921 .

1931 ———○———
 1921 - - - - -●- - - - -

CUMULATIVE CURVE OF THE AGE - DISTRIBUTION OF EVERY THOUSAND OF EACH SEX IN CENTRAL INDIA , 1931 .

MALES ———○———
 FEMALES - - - - -●- - - - -

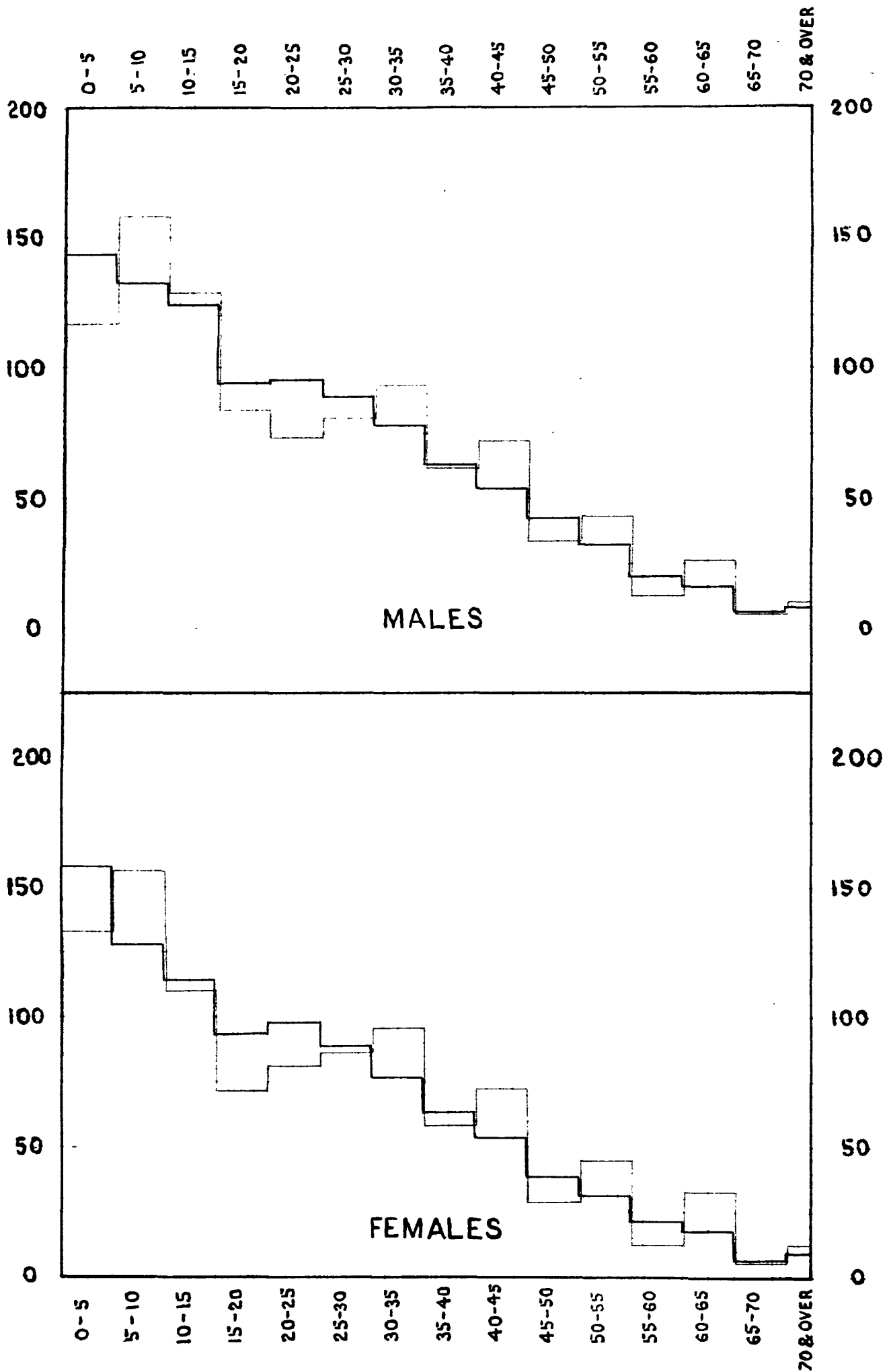

AGE DISTRIBUTION OF EVERY 1,000 OF EACH SEX IN CENTRAL INDIA
1921 (RED) & 1931 (BLACK)

Exaggeration in old age is natural when the span of life in India is short. In some parts a ceremony is performed to mark the completion of the sixtieth year and those living beyond 60 are prone to exaggerate their ages.

88. **Distribution of the population by sex and age-periods.**—In Subsidiary Table I (a) the age distribution of 10,000 of each sex by quinquennial age-periods is given and the diagram illustrates the same. From the 1931 figures we have been able to form a graded pyramid, except for a slight deviation in the age-period 15-20.

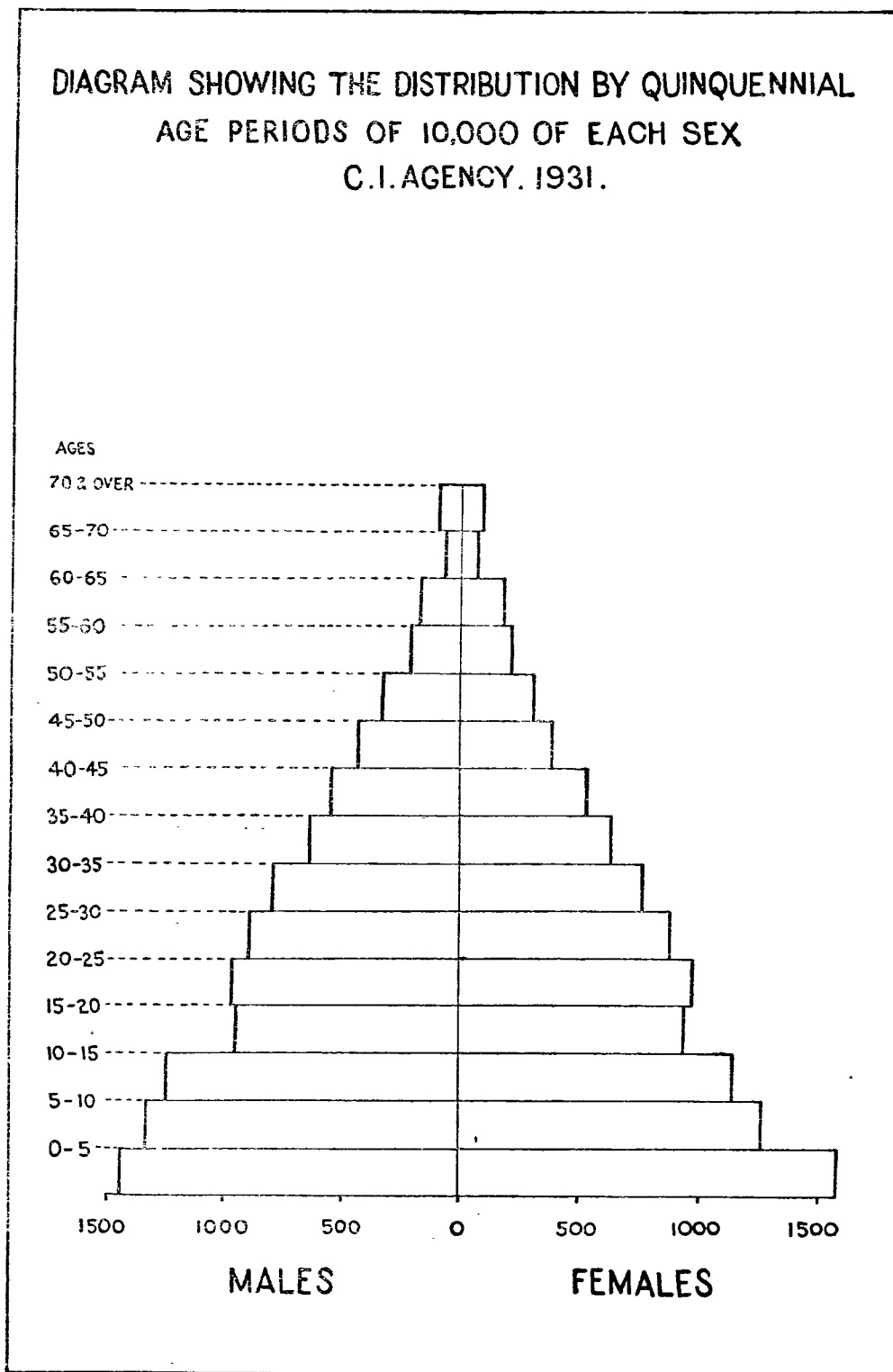

In the marginal table the change in the age constitution of the population for the two Censuses is given by showing the age distribution of 10,000 of each sex. The diagrams opposite bring out the same in an effective manner. One

of them shows the age distribution by quinquennial periods the figures being taken from this table and the other gives the cumulative curves for the same. If the age statistics were correct and if we had comparative figures for this Agency from 1901 Census, we could have obtained some idea about the effect of the famine and the epidemics in the previous decades on the age constitution of the people. For the famine in 1899 and the Influenza epidemic in 1919 bore heavily on Central India. It is not profitable to theorize in the absence of figures to guide us.

Age distribution of 10,000 of each sex at 1931 and 1921 Censuses.

Age.	1931.		1921.	
	Males.	Females.	Males.	Females.
1	2	3	4	5
0—5 . . .	1,433	1,586	1,165	1,326
5—10 . . .	1,323	1,276	1,539	1,580
10—15 . . .	1,245	1,148	1,294	1,100
15—20 . . .	944	946	846	707
20—25 . . .	950	960	738	809
25—30 . . .	891	885	806	860
30—35 . . .	780	753	941	952
35—40 . . .	638	632	626	581
40—45 . . .	547	530	725	713
45—50 . . .	425	391	344	293
50—55 . . .	324	308	435	450
55—60 . . .	201	213	127	122
60—65 . . .	161	181	258	326
65—70 . . .	57	653	54	56
70 and over . . .	81	98	102	125

glance at the distribution of the population in larger categories in accordance with the theories of M. Sündbörg. This Swedish statistician has showed that in all Western countries the number of persons aged 15-50 is uniformly about half the total population and that any variations which occur mainly take place in the other two categories, *viz.*, 0-15 and 50 and over. Where the population is growing the number in the former group is greater than in the latter but they approach equality if the population is stationary. The table below gives the types of population and the distribution according to Sündbörgian categories.

Types of population and distribution according to Sündbörgian categories.

Age-periods.	PROPORTION OF 1,000 OF THE POPULATION IN CERTAIN AGE-PERIODS.												
	BY RELIGION.					BY LOCALITY.					TYPICAL.		
	All Religions.		Hindu.	Muslim.	Tribal.	Indore.		Rewa.		Jhabua.	Progressive.	Stationary.	Regressive.
	1931.	1921.				1931.	1921.	1931.	1921.				
1	2	3	4	5	6	7	8	9	10	11	12	13	14
0—15 . . .	401	400	398	390	461	388	385	408	412	474	400	330	200
15—50 . . .	515	497	517	515	471	520	508	513	491	462	500	500	500
50 and over . . .	84	103	85	95	68	92	107	79	97	64	100	170	300

The fact that the age-group 15-50 contains half the total population generally holds good as seen from the table but the proportions are disturbed owing to adverse effects produced by famine, epidemics and other calamities. There is also variation in different religions and the deviation in the case of the Tribals is more marked. The proportions also vary by locality and in the table Jhabua has been specially shown to mark off the contrast. The figures here are influenced by the large Bhil population who form the bulk of the inhabitants of this locality. The distribution appears to be of progressive type for the Agency as a whole. In the decade there is a slight advance in the first age-period and a depletion in the third one, and the adolescent period has been considerably replenished and well filled.

89. Mean Age.—The mean age for the different Religions and Natural Divisions has been worked out for this and the last Census in the manner described in page 300 of the India Administrative Report of the Census of 1901 as

simplified in a worked out example supplied by the Census Commissioner. As the Census Commissioner's note says :—

The mean age, it will be noted, refers to the average age of the persons who were alive on the date of the Census : it does not coincide with the mean duration of life, except where the births and deaths exactly balance one another. In a growing population with a large number of children the mean age of the living will be less than in a decadent one where the children are relatively few in number. The mean age therefore explains nothing in itself but is useful in respect of the questions which it suggests and this fact must be borne in mind when dealing with the variations in the mean age in different localities and communities.

In both the sexes the mean age is lower than what it was ten years ago.

Mean age by Sex.

Year.	MEAN AGE FOR	
	Males.	Females.
1	2	3
1921 . . .	24.27	24.39
1931 . . .	23.25	23.15

A low mean age may mean a larger number of children due to high birth-rate attended with less mortality in the earlier periods. It may also mean a low longevity. In the absence of other information, no useful inferences are possible. From Subsidiary Tables II and V-A the marginal statement has been prepared to show the

mean age by religions and the number of children under 10 and the number of

Mean age by religion and proportion of children and old persons.

Religion.	Mean age.	Proportion of children under 10 per 100 persons aged 15—40.	Proportion of persons over 60 per 100 persons aged 15—40.
1	2	3	4
Hindu . . .	23.25	66	7
Muslim . . .	24.25	65	9
Tribal . . .	21.4	86	6

persons over 60 per 100 adult persons in each of the three religions. The Tribals have the largest proportion of children, are relatively short-lived and have the lowest mean age. The Hindus are slightly more prolific than the Muslims. The Muslims have the highest mean age, and they are longer-lived than the Hindus. As the age returns of the females are inaccurate, the figures in the table refer to males only.

90. Age distribution by Religion and Caste.—In Subsidiary Table II the age distribution by certain age-periods in the main religions has been worked out and is conveniently summarised in the table below :—

Age distribution by religion for 1931 and 1921 Censuses.

Religion.	Year.	PROPORTION PER MILLE OF MALES IN CERTAIN AGE-GROUPS IN 1921 AND 1931.					Mean age.
		0—5.	5—15.	15—40.	40—60.	60 and over.	
1	2	3	4	5	6	7	8
Hindu . . . {	1931	142	257	422	150	30	23.25
	1921	114	284	397	163	41	24.30
Muslim . . . {	1931	135	245	423	159	38	24.25
	1921	111	251	407	177	54	25.85
Tribal . . . {	1931	174	285	382	135	24	21.4
	1921	152	315	352	149	33	22.17
Jain . . . {	1931	121	208	441	187	43	26.05
	1921	99	227	418	198	59	27.29

These figures are in accordance with the experience of the previous Censuses. The Tribals who practise post-puberty marriages, have a larger proportion of children in the early age-groups and they are short-lived. The Muslims are less prolific than the Hindus. It is partly because they contain considerable male immigrant element amongst them. The Jains have the least proportion of children amongst the different religions. On the other hand the Jains are long-lived. Muslim males as well as females are longer-lived than the Hindus. The changes noticeable since 1921 are, the age-group 0-5 is being replenished while the period 5-15 registers a fall. The loss sustained in the younger adult age-group in the

previous decade is made good by a substantial rise in the age category 15-40.

Proportion of males in certain age-groups among certain castes.

Caste.	Proportion per mille of males in certain age-groups.	
	0-6.	44 and over.
1	2	3
Jat	157	156
Jolaha	159	155
Brahman	160	159
Kayastha	160	182
Bania	163	161
Rajput	164	157
Ahir	179	135
Balai	193	147
Chamar	197	124
Gond	213	132
Bhil	235	114
Baiga	248	118

While there was a rise in the later adult and old ages in the previous decade, there is a well-marked fall on the present occasion. From this we can broadly infer that the population is making good the void that was created in its age-groups by the adverse mortality effects operating in the previous decades. In Subsidiary Table III large number of castes have been shown together with their age distribution. The marginal table reproduces some salient figures from it. The proportion of children diminishes as we go up the social scale. The primitive tribes are decidedly more prolific than the higher castes and are short-lived. The upper castes have the fewest children and are long-lived. There are certain disturbing factors to this broad generalisation. It is not clear why the Jolaha should be less prolific than the

Brahman and why the Jat should take the first place in the list.

91. Natural fecundity.—In Subsidiary Tables V and V-A the proportion of children under 10 and of persons over 60 to those aged 15-40 and also of married

Proportion of children under 10.

Agency and Natural Division.	PROPORTION OF CHILDREN UNDER 10 (BOTH SEXES) PER 100.			
	PERSONS AGED 15-40.		MARRIED FEMALES AGED 15-40.	
	1931.	1921.	1931.	1921.
1	2	3	4	5
Central India Agency	67	71	162	176
West	68	73	166	180
East	65	70	157	172

females aged 15-40 per 100 males, is worked out by locality and religion and in Table IV by selected castes. The marginal figures are taken from Subsidiary Table V. A better measure of the natural fecundity is obtained if we consider the figures given in columns 4 and 5 as the number of children of both sexes are proportioned per cent. to married females aged 15-40, *i.e.*, to the reproductive ages of the females. There is a fall in both the natural divisions

and every locality shown in the table registers a regular fall without any exception. The fall in the proportions would indicate a general decrease in the fecundity of the people and one may be tempted to infer that there is a deliberate avoiding of child-bearing. But there is a danger of drawing any such conclusion regarding comparative fertility from proportional figures of this kind as was pointed out in the India Report of 1921 (paragraph 108). The ratio of children (and their rise and fall) is controlled by the number in the adult categories and especially of the number of married females. The ratio would fall if this category is replenished as has happened in this decade and it would rise if it is depleted as it happened owing to selective mortality in 1921. The variation of fecundity by religion shows that the Hindus and the Tribals have experienced a decrease while the Muslim figures indicate no change. Muslim fecundity has risen in the West and has declined in the East. No explanation can be sought for without the vital statistics.

92. Fecundity by religion and caste.—The proportion of children under ten per cent. of the married females aged 15-40, may be taken as a fair index of the relative fecundity of different religions. The proportion of such numbers amongst the Tribals is 195, in the Muslims 161 and in the Hindus 159. Subsidiary Table IV gives the proportion of children under 14 and of persons over 43 to those aged 14-43 in certain castes. The proportion of children under 14 per 100 married females aged 14-43 is highest among the primitive tribes like Baiga (205), Bhil (229) and Gond (187) and is considerable amongst the Pathan (187) and Sheikh (184). Amongst the Hindu castes there appears to be no definite correlation between fecundity and the social strata. According to the figures, the Brahman

is more prolific than the Chamar and the Kayastha more than the low caste of Kotwar. In this comparison we should also not lose sight of the fact that the age-returns in different strata are bound to vary considerably in the degree of accuracy.

93. **Longevity.**—In order to obtain a measure of fecundity we took the proportion of children under 10 per cent. of married females aged 15-40. Similarly to know the longevity of the sexes, we calculate the proportion of persons

Proportion of persons aged 60 and over to those aged 15-40.

Natural Division.	PROPORTION OF PERSONS AGED 60 AND OVER PER 100 AGED 15-40.							
	ALL RELIGIONS.		HINDU.		MUSLIM.		TRIBAL.	
	Males.	Fe-males.	Males.	Fe-males.	Males.	Fe-males.	Males.	Fe-males.
1	2	3	4	5	6	7	8	9
Central India Agency	7	8	7	8	9	9	6	7
West	8	9	8	9	9	9	6	7
East	6	8	6	8	6	9	6	5

aged 60 and over not on the whole population which includes children but on the adults aged 15-40. If the proportion of children is large in a population, the number in the adult categories would be smaller and the proportion of people aged 60 and over smaller still. The marginal table gives

the proportional figures for longevity by Sex, Religion and Natural Divisions. Bearing in mind that inaccuracies in age returns are more common among females, we can say that women are more long-lived than men. The Muslim figures suggest equality but the 1921 figures show that the female proportion was higher. We have already noticed that the tribals are short-lived and the figures confirm this conclusion again. There are regional fluctuations which credit them with greater longevity but these are to be attributed to the vagaries of age-returns. The Hindu females are less long-lived than the Muslim women. Owing to the presence of a large number of widows in the Hindu population, and the absence of the custom of widow re-marriages generally among them, it would be more reasonable to expect that the Hindu women should possess better chances of life. The lowering of the Hindu figures may possibly be due to the fact that the Hindu element contains a large number of the so-called Hinduised tribals and the lower castes who practise widow re-marriage. The Hindu widow of the upper classes leads a sheltered existence and she is not subject to child-bearing in the adult life if she has become a widow early but a re-marriage means she is again exposed to risks and chances of mortality which are greater in the ignorant sections of the population in the rural parts and comparatively less in the urban Muslim population, even though the latter practise widow re-marriage.

SUBSIDIARY TABLE I (a).

Age distribution of 10,000 of each Sex in Central India.

Age.	CENTRAL INDIA.					
	1931.			1921.		
	Persons.	Males.	Females.	Persons.	Males.	Females.
1	2	3	4	5	6	7
0—1	278	267	285	228	227	229
1—2	295	277	314	184	174	194
2—3	317	292	343	239	219	260
3—4	319	302	337	299	269	332
4—5	300	295	307	293	276	311
<i>Total 0—5</i>	<i>1,507</i>	<i>1,433</i>	<i>1,586</i>	<i>1,243</i>	<i>1,165</i>	<i>1,326</i>
5—10	1,300	1,323	1,276	1,559	1,539	1,580
10—15	1,198	1,245	1,148	1,199	1,294	1,100
15—20	945	944	946	778	846	707
20—25	965	950	980	773	738	809
25—30	888	891	885	833	806	860
30—35	772	780	763	947	941	952
35—40	635	638	632	604	626	581
40—45	539	547	530	719	725	713
45—50	408	425	391	319	344	293
50—55	316	324	308	442	435	450
55—60	207	201	213	125	127	122
60—65	171	161	181	291	258	326
65—70	68	57	63	55	54	56
70 and over	89	81	98	113	102	125
Mean Age	23·25	23·15	..	24·27	24·39

SUBSIDIARY TABLE I (b).

Age distribution of 10,000 of each Sex in Natural Divisions of Central India.

Age.	WEST.				EAST.			
	1931.		1921.		1931.		1921.	
	Males.	Females.	Males.	Females.	Males.	Females.	Males.	Females.
1	2	3	4	5	6	7	8	9
0—5	1,443	1,627	1,220	1,414	1,422	1,541	1,102	1,233
5—10	1,308	1,293	1,504	1,564	1,340	1,257	1,577	1,597
10—15	1,218	1,178	1,211	1,044	1,276	1,116	1,383	1,158
15—20	922	974	737	674	969	916	963	740
20—40	3,246	3,167	3,193	3,222	3,274	3,360	3,026	3,183
40—60	1,521	1,404	1,680	1,565	1,469	1,483	1,579	1,593
60 and over	342	357	455	517	250	327	370	496
Mean Age	24·10	22·90	24·71	24·28	22·90	23·45	23·80	24·53

SUBSIDIARY TABLE II.

Age distribution of 10,000 of each Sex in Main Religions.

Age and Religion.	CENTRAL INDIA.				WEST.				EAST.			
	1931.		1921.		1931.		1921.		1931.		1921.	
	Males.	Females.	Males.	Females.	Males.	Females.	Males.	Females.	Males.	Females.	Males.	Females.
1	2	3	4	5	6	7	8	9	10	11	12	13
HINDU.												
0—5	1,424	1,566	1,143	1,297	1,428	1,598	1,191	1,370	1,420	1,536	1,101	1,230
5—10.	1,319	1,266	1,530	1,567	1,298	1,276	1,473	1,534	1,340	1,257	1,381	1,595
10—15.	1,247	1,145	1,307	1,110	1,214	1,176	1,219	1,050	1,278	1,117	1,387	1,161
15—20.	948	949	858	715	925	983	744	684	971	917	966	741
20—40.	3,270	3,278	3,116	3,204	3,262	3,183	3,216	3,227	3,276	3,365	3,026	3,184
40—60.	1,496	1,453	1,634	1,597	1,526	1,422	1,697	1,609	1,466	1,482	1,572	1,593
60 and over	296	343	412	510	347	368	460	526	247	326	367	496
Mean Age	23·25	23·25	24·30	24·53	23·70	23·05	24·91	24·55	22·90	23·45	23·76	24·52
MUSLIM.												
0—5	1,347	1,586	1,105	1,320	1,340	1,593	1,108	1,346	1,371	1,563	1,098	1,238
5—10.	1,270	1,287	1,321	1,455	1,264	1,306	1,292	1,437	1,289	1,223	1,419	1,511
10—15.	1,177	1,142	1,193	1,043	1,162	1,161	1,163	1,040	1,229	1,078	1,279	1,055
15—20.	927	943	780	689	922	957	752	677	945	898	870	723
20—40.	3,305	3,203	3,291	3,294	3,316	3,178	3,344	3,300	3,266	3,285	3,130	3,264
40—60.	1,590	1,448	1,773	1,617	1,600	1,413	1,776	1,616	1,554	1,568	1,760	1,633
60 and over	384	391	537	582	396	392	565	584	346	385	444	576
Mean Age	24·25	23·35	25·85	25·09	24·40	23·15	26·10	25·03	23·80	23·95	24·80	25·27
TRIBAL.												
0—5	1,743	1,946	1,521	1,708	1,745	1,957	1,567	1,756	1,727	1,870	1,194	1,371
5—10.	1,507	1,457	1,920	1,689	1,512	1,464	1,948	1,885	1,479	1,414	1,725	1,912
10—15.	1,344	1,223	1,232	1,035	1,357	1,232	1,211	1,014	1,265	1,160	1,379	1,183
15—20.	867	904	694	611	864	905	655	592	883	895	969	714
20—40.	2,956	3,010	2,821	3,084	2,949	2,984	2,844	3,088	3,002	3,180	2,674	3,054
40—60.	1,347	1,199	1,485	1,279	1,335	1,190	1,457	1,269	1,424	1,258	1,680	1,384
60 and over	236	261	327	394	238	268	318	396	220	223	379	382
Mean Age	21·40	20·90	22·17	21·89	21·40	20·85	21·99	21·78	21·70	21·35	23·45	22·66
JAIN.												
0—5	1,211	1,373	987	1,116	1,201	1,355	966	1,109	1,242	1,426	1,044	1,131
5—10.	1,052	1,116	1,092	1,218	1,008	1,109	1,044	1,180	1,187	1,135	1,222	1,305
10—15.	1,028	1,002	1,175	959	986	1,016	1,164	956	1,163	961	1,203	968
15—20.	998	932	844	771	1,007	962	937	786	971	842	865	735
20—40.	3,412	3,273	3,336	3,251	3,440	3,261	3,371	3,280	3,324	3,310	3,243	3,189
40—60.	1,873	1,820	1,979	1,957	1,918	1,817	2,013	1,960	1,732	1,830	1,890	1,956
60 and over	426	484	587	728	440	480	605	729	381	496	533	716
Mean Age	26·05	25·70	27·29	27·52	26·35	25·65	27·63	27·60	25·00	25·80	26·36	27·33
CHRISTIAN.												
0—5	1,163	1,645	1,026	1,632	1,153	1,633	1,064	1,660	1,671	1,815	773	1,333
5—10.	1,080	1,509	1,036	1,665	1,077	1,552	1,058	1,677	1,144	924	885	1,533
10—15.	1,019	1,372	736	1,096	1,011	1,385	763	1,095	1,144	1,188	520	1,109
15—20.	1,146	1,012	1,074	597	1,131	994	1,169	608	1,056	1,254	421	521
20—40.	4,167	3,204	5,149	4,033	4,226	3,185	4,933	4,027	3,196	3,466	6,643	4,105
40—60.	1,286	1,076	837	801	1,268	1,070	856	760	1,613	1,155	688	1,205
60 and over	117	182	142	176	114	181	153	173	176	198	70	194
Mean Age	22·95	20·80	23·12	20·33	23·00	20·75	22·92	20·08	22·75	21·95	24·56	22·63
OTHERS.												
0—5	1,334	1,537	690	1,260	1,364	1,506	649	1,262	1,183	1,696	1,224	1,092
5—10.	1,059	1,135	1,125	1,189	1,038	1,150	1,116	1,194	1,165	1,037	1,225	1,091
10—15.	914	1,091	915	1,003	886	1,068	875	978	1,057	1,211	1,429	1,454
15—20.	1,021	1,099	804	910	1,017	1,059	851	880	1,040	1,300	204	1,454
20—40.	3,604	3,401	3,795	3,567	3,558	3,520	3,836	3,592	3,835	2,797	3,265	3,454
40—60.	1,707	1,378	2,113	1,588	1,744	1,341	2,128	1,605	1,523	1,561	1,939	1,091
60 and over	361	359	558	483	393	356	545	489	197	375	714	364
Mean Age	25·20	23·40	28·69	25·48	25·56	23·55	28·84	25·53	24·30	23·35	26·79	22·68

SUBSIDIARY TABLE III.

Age distribution of 1,000 of each Sex in certain castes.

Caste.	NUMBER OF MALES PER MILLE AGED.						NUMBER OF FEMALES PER MILLE AGED.					
	0—6.	7—13.	14—16.	17—23.	24—43.	44 and over.	0—6.	7—13.	14—16.	17—23.	24—43.	44 and over.
1	2	3	4	5	6	7	8	9	10	11	12	13
1. Ahir	179	176	79	117	314	135	200	162	67	122	311	138
2. Baiga (Hindu and Tribal).	248	172	72	96	294	118	258	154	65	110	303	110
3. Balai	193	172	72	117	299	147	203	163	73	130	287	144
4. Bania	163	153	72	137	314	161	175	152	62	129	310	172
5. Banjara (Hindu and Tribal).	196	196	76	116	283	133	227	171	71	128	285	118
6. Bansphor . . .	189	179	85	129	287	131	206	160	73	128	302	131
7. Bhil (Hindu and Tribal).	235	200	67	100	284	114	259	182	68	120	269	102
8. Brahman . . .	160	166	81	129	305	159	173	153	63	121	319	171
9. Chamar	197	183	82	119	295	124	207	165	74	124	305	125
10. Dhobi	191	171	79	121	301	137	195	161	68	126	305	145
11. Gadaria . . .	182	185	81	120	298	134	197	174	82	126	292	129
12. Gujar	162	171	75	121	313	158	188	167	72	133	293	147
13. Gond (Hindu and Tribal).	213	177	72	104	302	132	231	157	64	113	310	125
14. Jat	157	155	75	134	323	156	174	159	65	134	293	175
15. Kachhi	187	177	80	118	308	131	199	162	67	123	314	135
16. Kayastha . . .	160	151	70	124	313	182	175	154	58	121	302	190
17. Koli	182	165	75	121	312	145	190	154	67	128	313	148
18. Kotwal (Hindu and Tribal).	183	167	77	128	307	138	184	148	71	126	321	150
19. Kurmi	175	170	81	119	310	145	188	166	67	120	312	147
20. Lodhi	180	177	75	113	303	152	186	158	73	130	304	149
21. Mali	171	164	77	121	312	155	184	156	66	135	305	154
22. Mehtar	203	185	73	112	300	127	212	161	68	131	298	130
23. Moghia (Hindu and Tribal).	209	207	68	116	275	125	229	174	72	120	279	126
24. Nai	176	165	75	124	315	144	191	155	65	128	310	151
25. Rajput	164	165	76	129	309	157	182	156	66	130	306	160
26. Sondhia	164	162	76	125	293	180	183	160	70	128	291	168
27. Sor (Hindu and Tribal).	184	178	126	118	253	141	185	183	110	119	276	127
28. Teli	195	173	73	117	305	137	204	159	68	124	304	141
<i>Muslim.</i>												
29. Jolaha	159	161	99	144	291	155	167	179	108	142	267	137
30. Pathan	169	163	33	123	315	167	198	170	58	126	298	150
31. Sheikh	169	168	66	125	309	163	197	166	62	129	293	153

SUBSIDIARY TABLE IV.

Proportion of children under 14 and of persons over 43 to those aged 14—43 in certain castes ;
also of married females aged 14—43 per 100 females.

Caste.	PROPORTION OF CHILDREN (BOTH SEXES) PER 100.		PROPORTION OF PERSONS OVER 43 PER 100 AGED 14—43.		Number of married females aged 14—43 per 100 females of all ages.
	Persons aged 14—43.	Married females aged 14—43.	Males.	Females.	
1	2	3	4	5	6
Ahir	70	176	27	28	42
Baiga (Hindu and Tribal)	89	205	25	23	40
Balai	75	175	30	29	42
Bania	63	171	32	34	39
Banjara	88	208	28	28	41
Bansphor	73	175	26	26	43
Bhil (Hindu and Tribal)	97	229	25	22	39
Brahman	64	180	31	34	38
Chamar	75	178	25	25	43
Dhobi	72	172	27	29	42
Gadaria	74	181	27	26	42
Gujar	68	171	31	29	43
Gond (Hindu and Tribal)	81	187	28	26	41
Jat	63	174	29	36	40
Kachhi	72	173	26	27	42
Kayastha	64	189	36	39	36
Koli	68	163	29	29	42
Kotwar (Hindu and Tribal)	66	157	27	29	43
Kurmi	69	167	28	29	43
Lodhi	70	179	31	29	41
Mali	66	169	30	30	41
Mehtar	78	187	26	26	42
Moghia (Hindu and Tribal)	88	209	27	27	40
Nai	68	169	28	30	42
Rajput	66	186	30	32	38
Sondhia	68	172	36	34	42
Sor (Hindu and Tribal)	73	175	28	25	43
Teli	74	174	28	29	43
<i>Muslim.</i>					
Jolaha	64	166	30	26	40
Pathan	71	187	33	31	40
Sheikh	71	184	33	32	40

SUBSIDIARY TABLE V.

Proportion of children under 10 and of persons over 60 to those aged 15—40 and also of married females aged 15—40 per 100 females.

Agency, Natural Divisions and States.	PROPORTION OF CHILDREN UNDER 10 (BOTH SEXES) PER 100.				PROPORTION OF PERSONS OVER 60 PER 100 AGED 15—40.				Number of married females aged 15—40 per 100 females of all ages.	
	Persons aged 15—40.		Married females aged 15—40.		1931.		1921.			
	1931.	1921.	1931.	1921.	Males.	Females.	Males.	Females.	1931.	1921.
1	2	3	4	5	6	7	8	9	10	11
CENTRAL INDIA AGENCY	67	71	162	176	7	8	10	13	36	33
West	68	73	166	180	8	9	12	13	35	33
1. British Pargana of Manpur	65	..	155	..	5	7	38	..
2. Indore	64	67	156	169	9	9	12	13	36	33
<i>Bhopal Agency.</i>										
3. Bhopal	66	69	163	167	8	9	11	14	35	33
4. Khilchipur	65	74	151	182	10	8	13	12	38	33
5. Narsingharh	65	70	154	176	10	9	15	14	36	33
6. Rajgarh	66	73	157	178	9	8	13	12	37	33
<i>Malwa Agency.</i>										
7. Dewas States	63	66	158	164	10	9	14	15	34	33
8. Jaora	70	72	170	183	9	10	13	15	34	31
9. Ratlam	67	69	167	172	7	9	9	13	35	33
10. Sailana	75	78	177	194	8	9	9	13	35	32
11. Sitamau	67	71	160	177	10	9	13	15	35	32
<i>Southern Central India States Agency.</i>										
12. Ali-Rajpur	92	99	239	263	7	8	8	11	29	28
13. Barwani	91	100	206	228	8	8	12	12	34	31
14. Dhar	71	76	171	183	8	9	10	13	35	32
15. Jhabua	89	101	207	234	6	6	9	11	34	31
16. Jobat	91	107	224	263	8	7	13	15	31	28
East	65	70	157	172	6	8	9	13	36	32
<i>Bundelkhand Agency.</i>										
17. Ajaigarh	61	68	151	171	5	6	8	11	37	32
18. Baoni	64	67	155	165	5	6	9	12	37	35
19. Bijawar	64	..	156	..	6	7	36	..
20. Charkhari	60	64	148	159	6	8	10	13	36	33
21. Chhatarpur	62	67	149	162	7	9	11	14	37	34
22. Datia	60	66	152	172	6	9	10	17	36	33
23. Orchha	65	70	156	172	6	8	8	12	36	34
24. Panna	62	69	153	176	5	7	9	12	36	32
25. Samthar	56	56	140	141	5	6	7	11	38	36
<i>Baghelkhand Agency.</i>										
26. Baraundha	67	..	170	..	5	6	35	..
27. Kothi	67	74	161	179	5	7	11	13	36	31
28. Maihar	60	70	141	171	5	6	10	12	38	32
29. Nagod	61	75	146	181	6	7	9	13	37	32
30. Rewa	68	72	161	176	6	8	9	12	36	32
31. Sohawal	66	67	153	165	6	8	10	13	36	32
Rest of Central India Agency	64	..	168	..	6	7	34	..

SUBSIDIARY TABLE V (a).

Proportion of children under 10 and of persons over 60 to those aged 15—40 in certain Religions ; also of married females aged 15—40 per 100 females.

Religion and Natural Divisions and States.	PROPORTION OF CHILDREN UNDER 10 (BOTH SEXES) PER 100.				PROPORTION OF PERSONS OVER 60 PER 100 AGED 15—40.				Number of married females aged 15—40 per 100 females of all ages.	
	Persons aged 15—40.		Married females aged 15—40.		1931.		1921.			
	1931.	1921.	1931.	1921.	Males.	Females.	Males.	Females.	1931.	1921.
1	2	3	4	5	6	7	8	9	10	11
CENTRAL INDIA AGENCY	67	71	162	176	7	8	10	13	36	33
Hindu	66	70	159	174	7	8	10	13	36	33
Muslim	65	64	161	161	9	9	13	15	36	34
Tribal	86	98	195	224	6	7	9	11	34	31
West	68	73	166	180	8	9	12	13	35	33
Hindu	67	70	164	171	8	9	12	13	35	34
Muslim	65	64	163	160	9	9	14	15	36	34
Tribal	87	100	197	226	6	7	9	11	34	32
1. British Pargana of Manpur	65	..	155	..	5	7	38	..
Hindu	53	..	138	..	5	10	38	..
Muslim	59	..	138	..	7	6	43	..
Tribal	77	..	167	..	6	4	39	..
2. Indore	64	67	156	169	9	9	12	13	36	33
Hindu	64	68	156	170	9	9	12	13	36	33
Muslim	63	62	157	155	9	9	13	14	37	35
Tribal	74	93	169	208	6	6	11	11	36	33
<i>Bhopal Agency.</i>										
3. Bhopal	66	69	163	167	8	9	11	14	35	33
Hindu	67	70	164	171	7	8	11	13	36	33
Muslim	67	62	170	162	8	9	14	15	35	33
Tribal	62	70	141	160	8	9	11	14	36	33
4. Khilchipur	63	74	151	182	10	8	13	12	38	33
Hindu	65	73	151	182	10	7	13	12	38	33
Muslim	63	73	158	178	12	9	15	16	35	40
Tribal	66	90	146	212	7	8	13	11	38	29
5. Narsingbgarh	65	70	154	176	10	9	15	14	36	33
Hindu	65	73	154	177	11	9	15	15	36	33
Muslim	64	66	156	166	11	10	17	18	37	33
Tribal	67	55	162	150	9	44	33	..	38	33
6. Rajgarh	66	73	157	178	9	8	13	12	37	33
Hindu	66	73	157	179	9	8	13	12	37	33
Muslim	67	68	161	192	11	8	15	13	36	29
Tribal	59	..	140	..	4	7	39	..
<i>Malwa Agency.</i>										
7. Dewas States	63	66	158	164	10	9	14	15	34	33
Hindu	62	66	158	165	10	9	14	15	34	33
Muslim	68	67	157	159	11	10	15	15	36	34
Tribal	68	71	152	167	7	6	10	10	39	35
8. Jaora	70	72	170	183	9	10	13	15	34	31
Hindu	70	73	172	187	8	9	12	14	34	31
Muslim	62	69	159	163	12	12	18	20	32	33
Tribal	84	94	193	226	6	7	13	11	34	30
9. Ratlam	67	69	167	172	7	9	9	13	35	33
Hindu	57	57	146	154	7	10	9	13	36	33
Muslim	65	64	161	157	8	9	13	14	37	35
Tribal	94	100	218	218	5	7	8	11	32	33
10. Sailana	75	78	177	194	8	9	9	13	35	32
Hindu	64	68	155	175	8	10	10	15	36	31
Muslim	55	59	144	157	11	10	13	13	38	36
Tribal	99	106	220	235	6	7	6	11	33	32

SUBSIDIARY TABLE V (a)—*contd.*

Proportion of children under 10 and of persons over 60 to those aged 15—40 in certain Religions ; also of married females aged 15—40 per 100 females—*contd.*

Religion and Natural Divisions and States.	PROPORTION OF CHILDREN UNDER 10 (BOTH SEXES) PER 100.				PROPORTION OF PERSONS OVER 60 PER 100 AGED 15—40.				Number of married females aged 15—40 per 100 females of all ages.	
	Persons aged 15—40.		Married females aged 15—40.		1931.		1921.		1931.	1921.
	1931.	1921.	1931.	1921.	Males.	Females.	Males.	Females.		
1	2	3	4	5	6	7	8	9	10	11
<i>Malwa Agency—concl.</i>										
11. Sitamau	67	71	160	177	10	9	13	15	35	32
Hindu	67	71	160	177	9	9	13	15	35	32
Muslim	72	79	161	181	15	13	20	14	38	32
Tribal	175	..	700	25	..	14
<i>Southern Central India States Agency.</i>										
12. Ali-Rajpur	92	99	239	263	7	8	8	11	29	28
Hindu	93	100	241	275	7	8	8	11	29	28
Muslim	71	57	178	158	8	10	8	17	34	34
Tribal	89	100	236	250	8	7	9	11	30	29
13. Barwani	91	100	206	228	8	8	12	12	34	31
Hindu	89	83	201	188	8	8	12	14	34	33
Muslim	73	75	168	176	10	11	15	15	35	33
Tribal	113	126	256	284	8	5	11	10	31	29
14. Dhar	71	76	171	183	8	9	10	13	35	32
Hindu	69	72	169	175	8	9	11	15	35	32
Muslim	67	70	162	170	9	9	13	16	36	33
Tribal	90	92	255	209	7	6	6	8	27	34
15. Jhabua	89	101	207	234	6	6	9	11	34	31
Hindu	66	88	163	216	6	7	9	12	36	31
Muslim	57	58	153	147	8	6	11	10	37	38
Tribal	96	110	219	267	6	6	9	11	33	29
16. Jobat	91	107	224	263	8	7	13	15	31	28
Hindu	92	106	227	268	8	7	12	15	31	27
Muslim	70	78	167	211	7	8	17	17	34	28
Tribal	111	..	261	13	14	..	29
East	65	70	157	172	6	8	9	13	36	32
Hindu	65	70	156	176	6	8	9	13	36	32
Muslim	65	66	154	162	8	9	11	14	36	33
Tribal	82	84	184	206	6	5	10	10	36	30
<i>Bundelkhand Agency.</i>										
17. Ajaigarh	61	68	151	171	5	6	8	11	37	32
Hindu	61	68	151	172	5	6	8	11	37	32
Muslim	62	67	148	165	7	8	11	12	39	34
Tribal	87	94	201	214	7	5	20	10	32	29
18. Baoni	64	67	155	165	5	6	9	12	37	35
Hindu	64	67	156	166	5	6	9	11	37	34
Muslim	63	65	149	154	6	11	12	18	36	35
Tribal
19. Bijawar	64	68	156	170	6	7	9	12	36	33
Hindu	63	68	155	170	6	7	9	12	36	33
Muslim	62	66	158	159	6	7	11	14	36	33
Tribal	80	..	187	..	4	5	34	..
20. Charkhari	60	64	148	159	6	8	10	13	36	33
Hindu	60	64	147	159	6	8	9	13	36	33
Muslim	64	65	157	154	26	9	15	15	34	33
Tribal	104	89	357	200	4	..	25	..	23	29
21. Chhatarpur	62	67	149	162	7	9	11	14	37	34
Hindu	62	67	149	163	7	9	11	14	37	34
Muslim	60	61	148	149	7	11	11	16	37	35
Tribal	85	..	216	11	10	..	32

SUBSIDIARY TABLE V (a)—concl'd.

Proportion of children under 10 and of persons over 60 to those aged 15—40 in certain Religions ; also of married females aged 15—40 per 100 females—cont'd.

Religion and Natural Divisions and States.	PROPORTION OF CHILDREN UNDER 10 (BOTH SEXES) PER 100.				PROPORTION OF PERSONS OVER 60 PER 100 AGED 15—40.				Number of married females aged 15—40 per 100 females of all ages.	
	Persons aged 15—40.		Married females aged 15—40.		1931.		1921.			
	1931.	1921.	1931.	1921.	Males.	Females.	Males.	Females.	1931.	1921.
1	2	3	4	5	6	7	8	9	10	11
<i>Bundelkhand Agency—concl'd.</i>										
22. Datia	60	66	152	172	6	9	10	17	36	33
Hindu	60	67	153	172	6	9	10	16	36	33
Muslim	60	65	153	170	10	11	14	22	35	31
Tribal
23. Orchha	65	70	156	172	6	8	8	12	36	34
Hindu	65	71	157	173	6	8	8	12	36	34
Muslim	65	64	150	154	7	10	9	15	36	35
Tribal	78	104	151	188	5	5	10	16	40	43
24. Panna	62	69	153	176	5	7	9	12	36	32
Hindu	62	68	153	175	5	7	9	12	36	31
Muslim	64	62	156	163	6	8	8	14	35	32
Tribal	85	..	222	11	10	..	28
25. Samthar	56	56	140	141	5	6	7	11	38	36
Hindu	56	55	139	140	4	6	6	11	38	36
Muslim	57	58	147	160	7	6	8	10	36	35
Tribal
<i>Baghelkhand Agency.</i>										
26. Baraundha	67	..	170	..	5	6	35	..
Hindu	64	..	164	..	4	6	36	..
Muslim	85	..	263	..	10	7	26	..
Tribal	82	..	191	..	4	4	34	..
27. Kothi	67	74	161	179	5	7	11	13	36	31
Hindu	66	74	160	178	5	7	11	13	35	31
Muslim	59	87	151	206	4	9	8	18	37	31
Tribal	75	..	166	..	6	4	38	..
28. Maihar	60	70	141	171	5	6	10	12	38	32
Hindu	60	70	141	172	5	6	10	12	38	31
Muslim	60	55	147	135	6	7	11	14	41	37
Tribal	62	..	163	..	8	11	33	..
29. Nagod	61	68	146	166	6	7	9	13	37	32
Hindu	61	68	145	166	6	7	9	12	37	32
Muslim	62	71	144	161	10	10	15	19	36	32
Tribal
30. Rewa	68	72	161	176	6	8	9	12	36	32
Hindu	68	72	160	176	6	8	9	12	36	32
Muslim	68	69	159	169	9	9	10	13	36	33
Tribal	85	83	192	203	6	6	10	10	35	31
31. Sohawal	66	67	153	165	6	8	10	13	36	32
Hindu	66	67	153	164	7	8	10	14	36	32
Muslim	54	72	131	253	5	5	7	8	39	23
Tribal	72	69	156	149	6	6	9	11	38	34
<i>Rest of Central India Agency</i>										
Hindu	64	..	168	..	6	7	34	..
Muslim	62	..	163	..	6	7	35	..
Tribal	70	..	176	..	8	7	36	..
Tribal	81	..	190	..	5	5	36	..

CHAPTER V.

Sex.

94. **Introductory.**—Statistics relating to sex combined with age and civil condition will be found in Imperial Table VII and those relating to sex, age and civil condition for selected castes in Imperial Table VIII. The following Subsidiary Tables have been compiled :—

- I—General Proportions of the Sexes by Natural Divisions and States.
- II—Number of females per 1,000 males at different age-periods by religions at each of the last three Censuses.
- III—Number of females per 1,000 males at different age-periods by religions and Natural Divisions (Census of 1931).
- IV—Number of females per 1,000 males for certain selected castes and tribes.

Subsidiary Tables V and VI have been omitted as no records of vital statistics are available for the Agency.

95. **Sex-proportion in actual population.**—Central India is one of the tracts in India where the males are in excess of the females. 3,405,438 males and 3,227,352 females were enumerated in the present Census. In the general population the males exceed the females by 178,086. There are 948 females per 1,000 males in Central India. The sex proportion in the different States is given in Subsidiary Table I and the same is illustrated in the map.

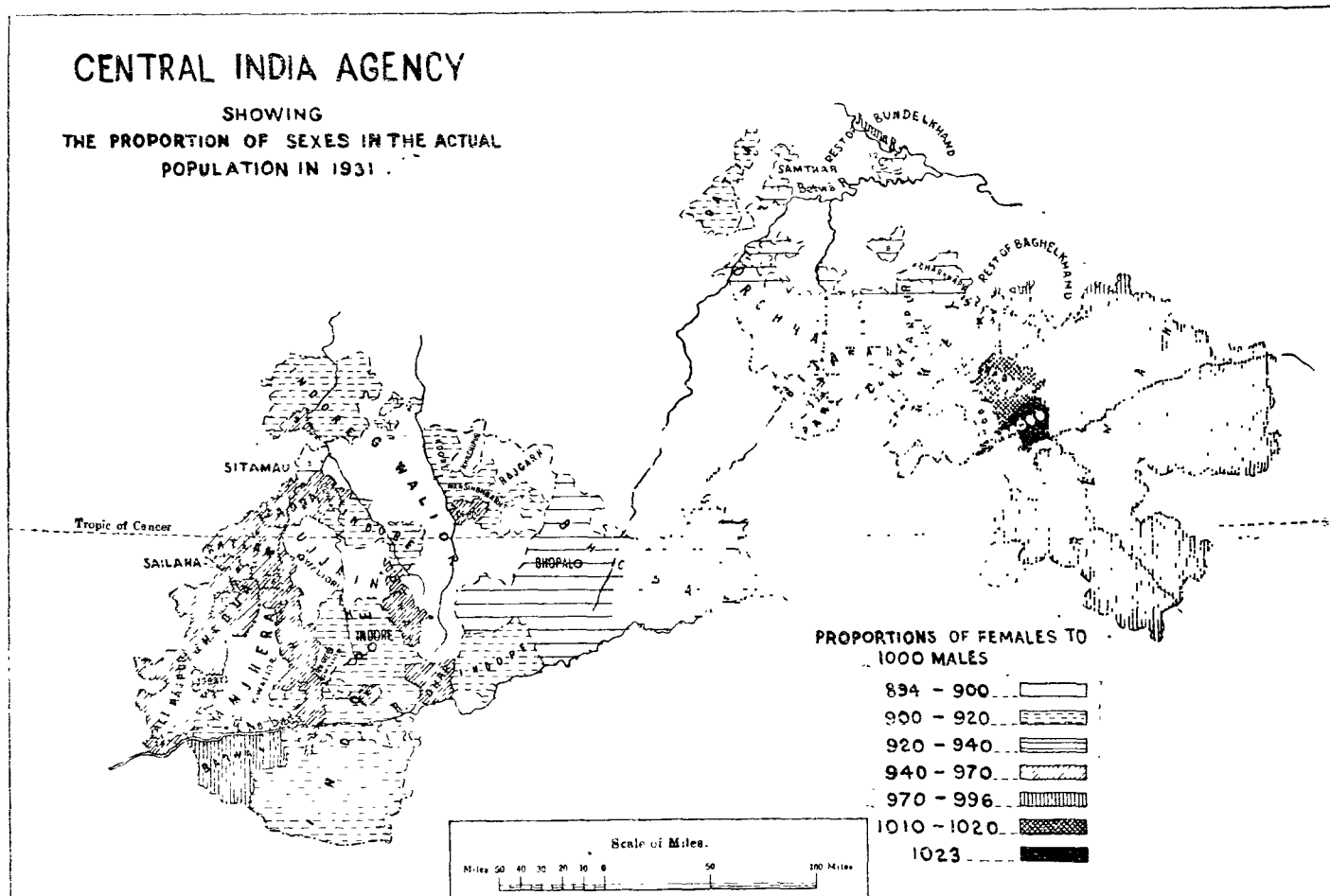

In the Bhopal Agency States which lie on the northern portion of the Plateau, the females decrease as we move from east to west. In Bhopal the deficiency of females is 69 per mille, in Narsinghgarh 88 per mille, in Rajgarh 105 per mille and in Khilchipur 106 per mille. The last is the lowest ratio for the West as well as for Central India. In central and western Malwa States the proportions are

higher and they occupy an intermediate position between the northern plateau and the hilly tracts in the south. The higher proportion in Sailana, Dhar and Ratlam is due to the presence of tribal population in the hilly parts of these States. In the southern parts, the deficiency of females in Jhabua is only 37 per mille and in Barwani it is only 26 per mille. In Ali-Rajpur the deficiency is slightly higher. It is 52 per mille. In the East as we move from Datia, the excess of males gradually decreases. Datia has a deficiency of 98 females per mille while Panna has only 38 per mille. As soon as we enter into Baghelkhand the deficiency of females gives place to excess of females in Maihar (1,023), Nagod (1,011) and Sohawal (1,015) and in Rewa (996) the sexes nearly equalize themselves. In Rewa the Kols migrate in considerable number to Assam. There is also a considerable drain of men to the neighbouring Central Provinces districts and the immigrants consist mostly of females. Further Rewa has a large population of primitive tribes. Complete figures are not available for the minor units. Perhaps the same causes operate in those areas also.

96. Variation in Sex-ratio.—The variation in sex-ratio since 1901 in

Sex-ratio since 1901.

Year.	Proportion of females to 1,000 males in actual population.
1	2
1901 . . .	973
1911 . . .	974
1921 . . .	954
1931 . . .	948

the actual population is shown in the margin. The female proportion which was stationary in the decade 1901-11 has continued to fall since then. The female deficiency was 27 per mille in 1901 and in 1921 it was 46 per mille while now it amounts to 52 per mille. Migration as a factor does not intrude itself in Central India. The effect of Influenza in 1921 is seen in the

decrease of the sex-ratio as it is generally thought that epidemics cause a greater

Comparison with other Provinces and Countries.

Country, Province or State.	Proportion of females to 1,000 males.
1	2
England and Wales (1921) . . .	1,096
Madras	1,025
Bihar and Orissa	1,008
Central Provinces and Berar	1,000
Central India Agency	948
India	940
Bombay Presidency	909
Rajputana Agency	908
United Provinces	902
Gwalior State	887
Punjab	831

mortality among women. In the absence of vital statistics this question cannot be further pursued. All that we can say is that the excess of males is more pronounced now than it was 30 years ago. The marginal table compares the sex-proportion of Central India with England and other Provinces in India. It is slightly higher than the average for India.

97. Accuracy of Sex returns.—No valid charge of inaccuracy in the sex returns can be laid against these parts. Prior to 1901, the census organisation in many States was perhaps not up to the mark. Since 1901, it has been brought up to the level of other parts of India. Since then every one understands the meaning of Census and there is no attempt to falsify the returns. Nobody escapes the vigilant eye of the local village enumerator and his knowledge about the inmates of each house is beyond doubt. He may go astray about birth-place, or language, or infirmity but it is never likely in the case of the inmates of either sex in each house in his charge. The fear of certain critics about the inaccuracy of the sex returns is baseless and finds no support from Central India where the males have grown in excess from 1901 to 1931 with the increasing accuracy and perfection in Census organisation.

98. Sex-proportion in Natural population.—The sex-proportion in actual population is 948. In calculating this proportion we have excluded persons born in Central India, who were absent on Census night. If we take the natural population, that is, those born in Central India, wherever enumerated we get the proportion of 940 females to 1,000 males. The immigrant population obviously contains a preponderance of females. These mostly come in marriage from the contiguous tracts of Central India. Migration as a factor in the disturbance of sex-ratio is negligible in Central India. We have no means of

knowing the effect of sex-ratio at birth and death on the distribution of sex figures. This enquiry is not possible till the States resort to the registration of births and deaths. As many of the Provinces have not supplied emigration figures by States for the Agency, the proportion of sexes in the natural population is not available in Subsidiary Table I and the same cannot be illustrated by a map.

99. Sex-proportion by Religion.—The number of females per 1,000 males in the different religions for this and the last Census is as below :—

Year.	PROPORTION OF FEMALES PER 1,000 MALES.			
	Hindu.	Muslim.	Tribal.	Jain.
1	2	3	4	5
1931 . . .	949	899	989	887
1921 . . .	954	913	1,002	913

As is to be expected the Tribals have a deficiency of 11 per mille only. The Hindus have 51 per mille and come next. They are followed by the Muslims who include amongst them a considerable proportion of male immigrants. The Jains who are traders have the lowest proportion. The figures for the Natural Divisions bear out the same fact. In the West where there is a large Muslim concentration having a foreign element in it, the sex-ratio is 887 females to 1,000 males. Whereas in the East with a more indigenous and immobile element it rises to 942. In the West the Jain female proportion is only 871. In the East it is as high as 939.

100. Sex-proportion by Age.—In Subsidiary Tables II, III and IV sex-proportions by age-groups are shown. The inaccuracy of age returns in females is very great and so a detailed study of the figures is bereft of any value. The diagram shows the sex-proportion by ages in the two Natural Divisions. It is now recognised as a fact that more males than females are born and the high male infantile mortality soon equalizes the proportion of males and females at a period which is dependent on the general rate of mortality. Considering the Census figures which are the only available ones in Central India it will be seen that in the West in the age period 0—1 there are 1,040 females to 1,000 males though purely by chance there are 980 females in the East in the same age period. Even a high infant mortality cannot reduce the male proportion so low. From the ages 1 to 3 females preponderate and there is a drop in the 4th year. Third perhaps is a favourite year for the females and the figures are concentrated in that age period. There is a drop in the age-group 10—15 due to understatement of the age of unmarried girls. There is again a rise in the period 15—25 due to the defective age returns and thereafter the females remain in considerable defect.

101. Sex-proportion by Caste.—The sex-proportions among non-Muslim castes are given in the margin in the order in which they stand. In this arrange-

Females per 1,000 males by Caste.

Caste.	Proportion.	Caste.	Proportion.
1	2	1	2
1. Kotwar (<i>Hindu and Tribal</i>).	1,026	13. Sor (<i>Hindu and Tribal</i>).	947
2. Gond (<i>Hindu and Tribal</i>).	1,018	14. Basor . . .	943
3. Balai . . .	1,004	15. Mehtar . . .	942
4. Baiga . . .	1,002	16. Mali . . .	940
5. Koli . . .	993	17. Lodhi . . .	937
6. Chamar . . .	983	18. Gadaria . . .	932
7. Dhobi . . .	979	19. Nai . . .	931
8. Bhil (<i>Hindu and Tribal</i>).	978	20. Bania . . .	928
9. Kachhi . . .	976	21. Brahman . . .	918
10. Teli . . .	968	22. Ahir . . .	914
11. Kurmi . . .	952	23. Rajput . . .	903
12. Moghia (<i>Hindu and Tribal</i>).	947	24. Sondhia . . .	883
		25. Banjara . . .	876
		26. Kayastha . . .	867
		27. Gujar . . .	864
		28. Jat . . .	827

ment we see that the proportion is highest amongst the Tribal groups and lower castes that are possibly allied to them. If the impure castes be considered the subjugated aborigines then the Chamar or the Balai come under that class and both have a high female proportion. Some of the good cultivating castes like Lodhi, Gadaria and Ahir have a lower female

proportion. The three upper castes, Brahman, Bania and Rajput, have the

DIAGRAM SHOWING THE NUMBER OF FEMALES
PER 1,000 MALES BY MAIN AGE PERIODS & BY THE
NATURAL DIVISIONS C.I. 1931.

WEST —○—
EAST —×—

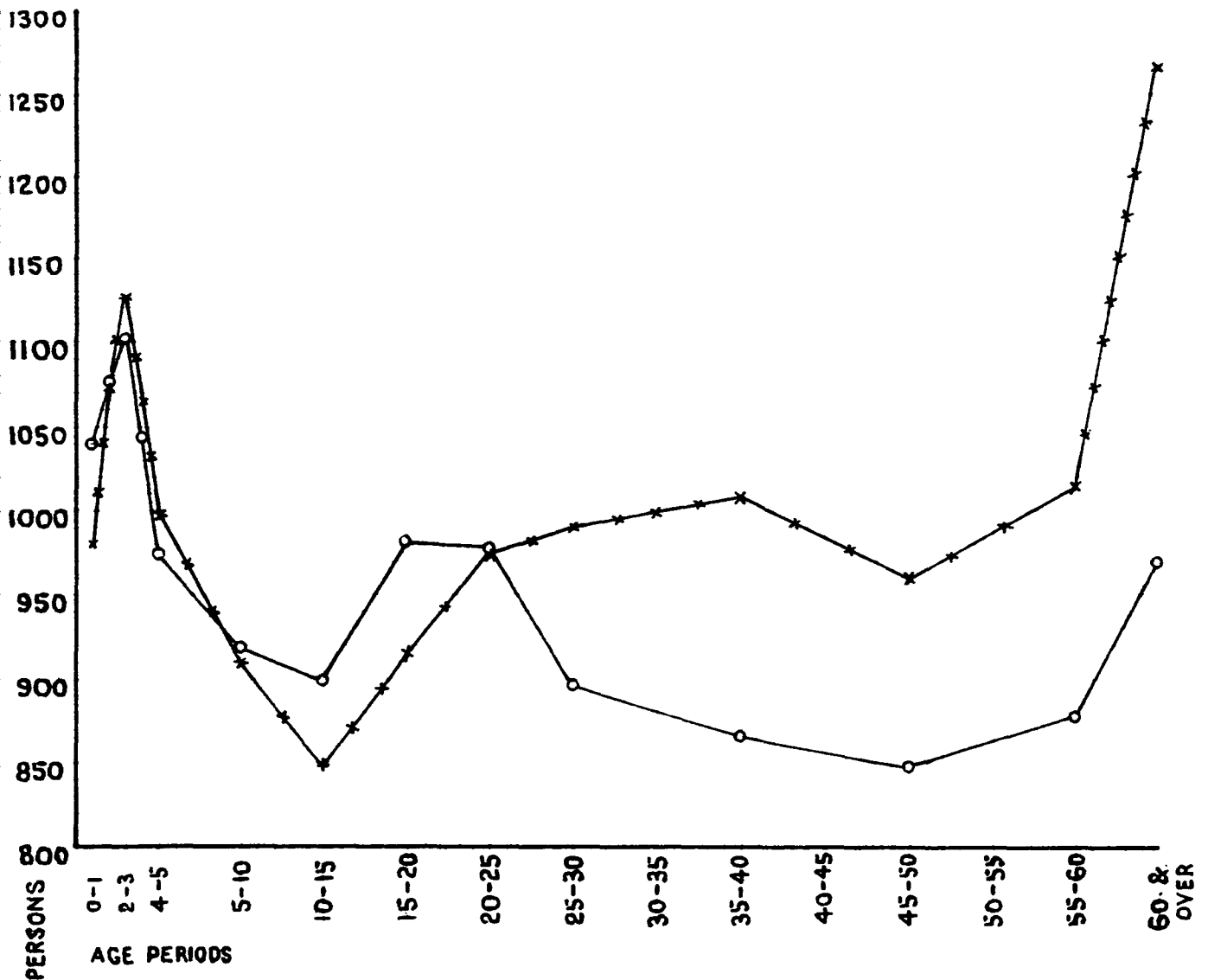

proportion of 918, 928 and 903, respectively. The literary caste of Kayasthas who seek mostly service in the States have a lower ratio. The Gujars and Jats who have a tradition for having a low proportion of women bring up the rear in this list. From the point of view of the influence of race on sex-ratio the value of the above arrangement should not be over-emphasised. We have yet to get hold of the right threads in the ethnic composition of the population. These castes are not races but they are products of centuries of in-breeding as well as cross-breeding. Some are degraded like Sondhias and Banjaras and others are elevated including certain Rajput clans and Brahman groups. It is only a fiction which holds that the top strain is necessarily Aryan and the lower one pre-Dravidian. The mixture is so great that it cannot be said in what proportions the strains have blended in them. The point is that race alone cannot give an adequate answer to our query. Climate, environment, birth and death rates and such other factors have to be correlated with each social group before we can arrive at any conclusion.

102. Reasons for the proportions.—What causes a variation in sex-ratio is still one of Nature's secrets and each savant has his own theory. It would be a rash impudence for an amateur compiler of a Census Report to invade the domain of biology and begin a discourse on X—Chromosome. All he can do is to state how one theory has been upset by another when at the end there is nothing to hold the field. Thus a century ago two eminent persons, Hofacker and Sadler, propounded a law that the sex of the off-spring is that of the older parent. This was contradicted by another eminent person, named Schultze, who worked on the unfortunate mice. Another theory was to the effect that the "Superior" parent tended to beget off-spring of the opposite sex. Science is stern and exacting and it was found impossible to define "vigour" and "superiority" in physiological terms. More recently the problem of masculinity at birth has been exhaustively examined by de Jasterzebski whose conclusions so far as their applicability to Indian conditions is concerned are (1) Masculinity at birth is affected by race; (2) the effect of cross-breeding is doubtful; (3) urbanization lowers masculinity, the ratios in rural areas being generally higher than those for urban areas and (4) masculinity is perhaps greater in the first than in the subsequent births. The absence of vital statistics rules out the first three conclusions being tested in these parts. As regards the last, special enquiries made in certain limited areas have been compiled and exhibited in the Appendix at the end of this chapter. The number of cases covered is small as it was found difficult to secure information in many of the States in this Agency.

In India the desire for male off-springs is very marked among all classes of Hindus both from religious and economical considerations. In the Aryan polity sons were more desired and this was perhaps even a necessity. The desire for male children was very strong and the birth of daughters was unwelcome. An old verse in the *Aitareya Brahmana* says that a daughter is a misery, while a son is a light in the highest heaven.* The following verse from the Rigveda which is even now recited in Hindu marriages according to the Vedic rituals is instructive on this point.

इ॒मां त्वमिन्द्र॑ मी॒द्वः सु॒पुत्रां॑ सु॒भगां॑ कृणु ।

द॒यास्यां॑ पु॒त्राना॑धेहि॒ पति॑मेका॒दशं॑ कृधि ।

The latter half of the stanza which is relevant to us may be rendered as "Put ten sons in her. Make her husband an eleventh." The logical incongruity of this is easily paralleled by the lines in *Paradise Lost*—

Adam the goodliest man of men since born
His sons, the fairest of her Daughter's Eve.

* Macdonnel and Keith, *Vedic Index* i, 487. In this connection it is interesting to read from the same high authorities that "there is no proof that the Vedic Indians practised the exposure of female children. This conclusion deduced from certain passages in later *Samhitas* by Zimmer and Delbrück, has been disproved by Böhtlingk" (*ibid*).

Manu went further. He laid down that a wife who bears only daughters may be put away. This ardent desire for males may have a psychological effect in influencing masculinity at birth, but it is extremely doubtful.

Leaving aside these interesting general considerations we come to certain specific causes which have been adduced for the prevalence of the lower proportion of females than males in the population of India. They are :—

- (a) Infanticide ;
- (b) Neglect of female children ;
- (c) Evil effects of early marriage and premature child-bearing ;
- (d) High birth-rate and primitive method of midwifery ;
- (e) Hard treatment accorded to women specially widows ; and
- (f) Hard work done by women.

There is no doubt that owing to the system of hypergamy infanticide was prevalent amongst certain Rajput clans in Central India. It was observed by Sir John Malcolm when the British entered Central India in 1818—

“ Infanticide is not known among the lower classes : this shocking custom appears limited to some Rajput chiefs of high rank and small fortunes who, from a despair of obtaining a suitable marriage for their daughters are led by an infatuated pride to become the destroyers of their off-spring. This usage is however on the decline ; and every effort has been made to prevent the recurrence of such crime.” In a foot-note to this paragraph Malcolm adds : “ With regard to infanticide I have ever, when it was mentioned, stated my abhorrence of the murders that were committed under the plea of this usage and refused to see those who practised it. Such sentiments were never found to give offence.” In another foot-note to the same paragraph, Malcolm adds : “ Various causes combine to excite or introduce this usage (infanticide) into a family. The petty Thakur or Lord of Cherawal (a relative of the Amjhera family) married a daughter to the Rawal of Banswarah thirty-four years ago. The pride of the Thakur’s family was so excited by this, that it was resolved no female should make an inferior match and the despair of such good fortune again had led to every child being killed. Suntook Ram, minister of Amjhera, told me he was sitting with Pudum Singh, the present Thakur, when he heard the birth of a female infant whispered in his ear. He saw him preparing between his fingers the fatal pill of opium (the usual signal), but he implored that the child might live : his request was granted, and this little girl (added Suntook Ram) now eight years of age, is always called my daughter.”*

Later history shows that infanticide was not declining as Malcolm thought. In 1835 Mr. Wilkinson found that not less than 20,000 female infants were yearly made away with in Malwa alone †. No attempt at concealing the practice was made and a careful examination showed that 34 per cent. of girls born were killed. In 1893 the question of female infanticide was raised in Rewa ‡ where a great deficiency of females was found to exist among Parihar, Kalchuri and Somvansi Rajputs. Measures were introduced for the surveillance of certain villages.

It cannot however be asserted that infanticide now prevails in any part of

Females to 1,000 males among Rajputs.

Age.	1931.	1921.
1	2	3
All Ages	903	929
0—6	1,001	1,042 (0—5)

Central India and much less it affects the sex proportion. Modern conditions have removed much of the rigour of hypergamy, facilitating the clans to make alliances in different parts of the country. In the rural parts the agricultural class of Rajputs are in no way tainted with this custom. The proportion of females per 1,000 males amongst the Rajputs is shown in the table. The proportion of female children is as high as in any of the classes who have no taint attached to their caste and so far as the figures show there is no reason to say that infanticide is prevalent among the Rajputs. The Rajputs include many septs or clan divisions and it is therefore not possible to analyse the figures for every one of

* *Memoir*, ii, 208-209.

† *Imperial Gazetteer*, Central India, 32.

‡ *Rewa State Gazetteer*.

them. In the table the sex-ratio is given for the Parihars in whom in Rewa the practice of infanticide was suspected and also for the Chauhans a dominant Rajput clan in Malwa.

Females to 1,000 males among Parihars and Chauhans.

Caste.	State.	NUMBER OF FEMALES TO 1,000 MALES.			
		1931.		1921.	
		All Ages.	0-6.	All Ages.	0-5.
1	2	3	4	5	6
Rajput Parihar . . .	Rewa . . .	837	871	1,060	875
	Indore . . .	890	814	780	950
	Nagod . . .	611	1,071	653	779
Rajput Chauhan . . .	Indore . . .	769	855	852	732
	Dhar . . .	1,073	1,224	1,111	1,043
	Ratlam . . .	784	1,265	809	603
	Rewa . . .	824	953	888	1,009

Excluding the literary caste of Kayasthas many of whom are foreign immigrants seeking service, four castes Sondhia (883), Banjara (876), Gujar (864) and Jat (827), have the lowest proportion of females as compared with the bulk of the important castes in Central India. Except that Sondhia and Banjara castes have been

formed out of the Rajput groups, no reason can be adduced as to the low proportion of females amongst them. In Appendix VI to the India Report of 1921, Mr. Marten classified Jat (Hindu) and Gujar as castes having a tradition for female infanticide. He exhibited the sex-ratio for them and added the remark that it was "quite useless and quite unnecessary to insist upon reasons for the low sex-ratio other than that which

Proportion of females in certain castes.

Caste.	NUMBER OF FEMALES TO 1,000 MALES.			
	1931.		1921.	
	All Ages.	0-6.	All Ages.	0-5.
1	2	3	4	5
Gujar . . .	864	998	916	1,335
Jat . . .	827	939	Not available.	
Brahman . . .	918	994	974	1,029
Bania . . .	928	1,002	894	1,052

these figures suggest, viz., the continued deliberate destruction of female infant life either by active or passive means." In Central India the sex proportions for Gujars and Jats along with Brahmans and Baniyas are shown in the table. The Gujars have a high proportion of females in the age-period 0-6 which is more than that of Sor who as a tribal people ought to have more. The good cultivating caste of Lodhi has the sex-ratio of 968 only. There is therefore no reason to suspect the somewhat lower proportions amongst the Jats.

Infanticide was once prevalent in Central India is an admitted fact. It was perhaps restricted to few Rajput clans amongst whom the practice of hypergamy was strong. As a widespread custom it does not exist in Central India though it is just possible that few isolated cases of passive neglect may account for the deliberate destruction of female life. Amongst such classes like Gujars and Jats who have elsewhere a reputation for female infanticide, the figures do not disclose any such practices. We may therefore conclude that infanticide as a factor has no influence on our figures.

As regards (e) and (f), hard treatment to women in India can easily be exaggerated. The Indian loves his children and has regard for his women folk. Amongst the higher classes the position of women is anything but one of cruelty or hard treatment. The joint family system in its unfavourable aspect might have contributed sometimes to the ill-treatment of women. Such state of affairs is becoming a thing of the past. In tropics men's passions are aroused sooner and they are less phlegmatic than people in the colder regions. Amongst the lower elements passion may temporarily seize hold of their better judgment and prudence. Instances of wanton and brutal cruelty which one comes across in official experience do not cover the normal life of an Indian house-hold. The effect of hard-work is perhaps the opposite of what it is held to be. Out-door work, exacting though it is, draws out the women to open air and to a more invigorating life. Agricultural castes like Kachhi and Lodhi, the hard working village drudges like the Balai and Chamar and such tribal groups like Gond, Bhil and Baiga have all a high proportion of women in the later age-periods. It is more the secluded woman of the higher castes who wastes away in diseases like consumption without fresh air and any physical exertion.

The causes enumerated in (c) and (d) have a closer bearing on the question under consideration. In a previous paragraph when dealing with the sex-propor-

tion by age we saw that the females lose their initial advantage after the age of 5 and their proportion drops down considerably in the age-group 10—15. This is noticeable in all the religions. The Hindus have a proportion of 872, Muslims 873 and Tribals 905. The proportion of girls married and widowed under 15 to the whole number of females is 9 per cent. among Hindus, 6 per cent. among Muslims and 5 per cent. among Tribals. The greater deficit of females seems therefore to be accompanied by early marriages. There is a rise again in the ages between 20 and 25. This rise is partly due to inaccurate age returns and perhaps also to the decrease in men who in prime of life are subject to risks. In 25—30 there is a further fall in the female proportion due to child-bearing, many times in rapid sequence, and to the after-effects of it, brought about by unskilled medical aid, crude midwifery, neglect and general ignorance. Just as in some Western countries the females gain advantage over men due to the hazard and risks in life to which the men are subjected and women are not, so in India it must be assumed that the females lose their advantage over the males because they are exposed to greater risks in life due to early marriages and premature child-bearing. The greatest risk to which women are subject is the rapidly successive child-bearing which works havoc in the already delicate constitution of women. The marital restrictions imposed and sanctioned by custom, and regulated in earlier times in the family have ceased to operate. A considerable period should intervene between one parturition and a second conception, in order that the woman's body may adapt itself to the physiological process of reproduction. It is the neglect of this consideration that is responsible for the sacrifice of many lives and more than to any other cause, it is to early marriage, premature child-bearing and excessively burdened motherhood that we should ascribe a greater mortality in women and a consequent deficiency in their numbers.

SUBSIDIARY TABLE I.

General proportions of Sexes by Natural Divisions and States.

Agency, Natural Divisions and States.	NUMBER OF FEMALES TO 1,000 MALES.			
	1931.		1921.	
	Actual population.	Natural population.	Actual population.	Natural population.
1	2	3	4	5
Central India Agency	948	940	954	951
West	921	}	935	945
British Pargana of Manpur	913		880	}
Indore	911		917	
<i>Bhopal Agency.</i>				
Bhopal	931		934	}
Khilchipur	894		887	
Narsingharh	912		917	
Rajgarh	895		902	
<i>Malwa Agency.</i>				
Dewas States	954		979	
Jaora	942		948	
Ratlam	948		946	
Sailana	962		950	
Sitamau	932		937	
<i>Southern Central India States Agency.</i>				
Ali-Rajpur	948	}	950	}
Barwani	974		990	
Dhar	967		986	
Jhabua	963		981	
Jobat	963		987	
East	968		975	
<i>Bundelkhand Agency.</i>				
Ajaigarh	942		954	}
Baoni	931		932	
Bijawar	920		923	
Charkhari	938		944	
Chhatarpur	924		926	
Datia	902		919	
Orchha	927		932	
Panna	962		957	
Samthar	924		891	
<i>Baghelkhand Agency.</i>				
Baraundha	903		924	}
Kothi	989		1,004	
Maihar	1,023		1,037	
Nagod	1,011		1,025	
Rewa	996		1,007	
Sohawal	1,015		1,025	
Rest of Central India Agency	933		941	

NOTE.—The figures for Khaniadhana have been included in the East.

SUBSIDIARY TABLE II.

Number of females per 1,000 males at different age periods by Religion.

Age.	All religions.		Hindu.		Muslim.		Tribal.		Jain.		Christian.		Others.	
	1931.	1921.	1931.	1921.	1931.	1921.	1931.	1921.	1931.	1921.	1931.	1921.	1931.	1921.
1	2	3	4	5	6	7	8	9	10	11	12	13	14	15
CENTRAL INDIA.														
0—1	1,013	961	1,004	957	1,068	964	1,119	997	924	1,006	986	893	968	1,000
1—2	1,076	1,064	1,071	1,063	1,062	1,050	1,154	1,087	1,041	1,050	1,014	940	1,093	944
2—3	1,113	1,135	1,110	1,132	1,102	1,078	1,168	1,220	1,058	1,062	1,085	1,069	902	1,421
3—4	1,055	1,180	1,052	1,173	1,066	1,276	1,089	1,206	1,011	1,004	1,156	991	857	2,286
4—5	986	1,074	983	1,073	992	1,082	1,028	1,083	1,005	1,053	1,046	831	885	2,000
<i>Total 0—5</i>	<i>1,049</i>	<i>1,086</i>	<i>1,044</i>	<i>1,033</i>	<i>1,058</i>	<i>1,089</i>	<i>1,110</i>	<i>1,125</i>	<i>1,006</i>	<i>1,033</i>	<i>1,047</i>	<i>938</i>	<i>940</i>	<i>1,452</i>
5—10	914	980	911	978	911	1,005	960	986	941	1,018	1,051	949	874	848
10—15	874	811	872	810	873	798	905	842	865	746	1,013	881	974	878
15—20	950	797	950	798	914	806	1,031	882	828	834	664	328	878	907
20—25	977	1,046	975	1,045	923	959	1,084	1,270	888	934	441	309	814	752
25—30	941	1,018	944	1,012	872	941	1,000	1,226	847	837	506	941	765	861
<i>Total 0—30</i>	<i>952</i>	<i>953</i>	<i>951</i>	<i>949</i>	<i>931</i>	<i>940</i>	<i>1,015</i>	<i>1,031</i>	<i>901</i>	<i>899</i>	<i>761</i>	<i>649</i>	<i>876</i>	<i>922</i>
30—40	932	932	938	936	835	873	974	964	829	896	785	373	742	550
40—50	899	899	907	908	816	822	879	844	856	888	608	548	667	623
50—60	939	970	951	984	823	850	898	905	872	927	684	612	644	560
60 and over	1,036	1,169	1,101	1,183	914	989	1,104	1,212	1,008	1,133	1,171	728	811	693
<i>Total 30 and over</i>	<i>938</i>	<i>955</i>	<i>946</i>	<i>964</i>	<i>837</i>	<i>870</i>	<i>943</i>	<i>943</i>	<i>865</i>	<i>933</i>	<i>730</i>	<i>447</i>	<i>710</i>	<i>656</i>
Total all Ages (Actual population).	948	854	949	954	899	913	989	1,002	887	913	752	591	816	801
Total all Ages (Natural population).	940	851

SUBSIDIARY TABLE III.

Number of females per 1,000 males at different age periods by Religions and by Natural Divisions.

Age.	All Religions.	Hindu.	Muslim.	Tribal.	Jain.	Christian.	Others.
1	2	3	4	5	6	7	8
WEST.							
0—1	1,040	1,029	1,076	1,140	864	955	923
1—2	1,077	1,070	1,056	1,103	1,004	1,023	1,013
2—3	1,102	1,096	1,081	1,169	1,069	1,109	870
3—4	1,044	1,037	1,059	1,088	1,017	1,144	813
4—5	974	964	998	1,132	980	1,050	872
<i>Total 0—5</i>	<i>1,048</i>	<i>1,040</i>	<i>1,053</i>	<i>1,117</i>	<i>982</i>	<i>1,054</i>	<i>901</i>
5—10	919	913	916	964	958	1,072	904
10—15	899	899	886	905	898	1,019	984
15—20	982	987	920	1,043	832	643	850
20—25	978	980	913	1,095	879	425	827
25—30	895	893	852	995	828	586	814
<i>Total 0—30</i>	<i>957</i>	<i>955</i>	<i>930</i>	<i>1,019</i>	<i>900</i>	<i>752</i>	<i>879</i>
30—40	865	865	805	959	788	775	790
40—50	847	853	780	879	823	607	646
50—60	878	888	787	906	827	682	597
60 and over	969	970	880	1,119	949	1,188	739
<i>Total 30 and over</i>	<i>873</i>	<i>876</i>	<i>803</i>	<i>939</i>	<i>824</i>	<i>725</i>	<i>707</i>
Total all Ages (Actual population).	929	929	887	996	871	744	816
Total all Ages (Natural population).							

Figures not available.

SUBSIDIARY TABLE III—concl'd.

Number of females per 1,000 males at different age periods by Religions and by Natural Divisions—concl'd.

Age.	All Religions.	Hindu.	Muslim.	Tribal.	Jain.	Christian.	Others.
1	2	3	4	5	6	7	8
EAST.							
0—1	980	977	1,142	991	1,148	1,444	1,200
1—2	1,074	1,073	1,088	1,091	1,161	923	2,167
2—3	1,126	1,124	1,176	1,158	1,029	846	1,077
3—4	1,066	1,065	1,090	1,093	994	700	1,077
4—5	997	998	976	1,003	1,075	1,000	947
<i>Total 0—5</i>	<i>1,050</i>	<i>1,048</i>	<i>1,074</i>	<i>1,068</i>	<i>1,078</i>	<i>965</i>	<i>1,167</i>
5—10	909	909	894	972	898	718	738
10—15	847	847	827	905	770	923	932
15—20	915	915	896	1,000	814	1,056	1,017
20—25	975	976	960	1,019	916	903	731
25—30	990	992	939	1,029	907	1,136	557
<i>Total 0—30</i>	<i>947</i>	<i>987</i>	<i>934</i>	<i>993</i>	<i>902</i>	<i>938</i>	<i>862</i>
30—40	1,008	1,010	944	1,072	965	929	545
40—50	959	960	948	884	967	614	792
50—60	1,013	1,017	955	845	1,033	727	906
60 and over	1,266	1,279	1,050	1,002	1,201	1,000	1,545
<i>Total 30 and over</i>	<i>1,014</i>	<i>1,017</i>	<i>958</i>	<i>970</i>	<i>1,005</i>	<i>795</i>	<i>726</i>
Total all Ages (Actual Population).	968	969	942	987	939	889	814
Total all Ages (Natural population).							

Figures not available.

NOTE.—Figures for Khaniadhana have been included in the East.

SUBSIDIARY TABLE IV.

Number of Females per 1,000 Males for certain Selected Castes.

Caste.	NUMBER OF FEMALES PER 1,000 MALES.						
	All ages.	0—6.	7—13.	14—16.	17—23.	24—43.	44 and over.
1	2	3	4	5	6	7	8
1. Ahir	914	1,021	841	776	951	907	934
2. Baiga (Hindu and Tribal).	1,002	1,039	900	895	1,104	1,033	941
3. Balai	1,004	1,054	948	1,022	1,114	964	989
4. Bania	928	1,002	925	813	880	918	969
5. Banjara	876	1,017	766	811	967	881	778
6. Bansphor	943	1,029	842	802	942	990	945
7. Bhil (Hindu and Tribal) . .	978	1,078	889	990	1,175	925	878
8. Brahman	918	994	849	716	854	962	985
9. Chamar	983	1,033	888	887	1,028	1,017	989
10. Dhobi	979	1,000	920	841	1,020	992	1,032
11. Gadaria	932	1,010	874	939	973	916	898
12. Gujar	864	998	843	835	946	810	804
13. Gond (Hindu and Tribal) . .	1,018	1,103	902	917	1,107	1,042	965
14. Jat	827	939	864	742	848	769	948
15. Kachhi	976	1,044	896	813	1,019	994	1,004
16. Kayastha	867	947	885	714	848	838	905
17. Koli	993	1,032	927	885	1,058	994	1,015
18. Kotwar (Hindu and Tribal)	1,026	1,034	906	942	1,007	1,073	2,132
19. Kurmi	952	1,028	926	786	967	956	963
20. Lodhi	937	968	836	918	1,077	941	916
21. Mali	940	1,011	895	802	1,054	919	936
22. Mehtar	942	982	819	871	1,106	937	967
23. Moghia (Hindu and Tribal)	947	1,038	795	1,004	981	960	951
24. Nai	931	1,009	872	801	964	917	976
25. Rajput	903	1,001	851	789	905	894	923
26. Sondhia	883	988	875	810	903	876	824
27. Sor (Hindu and Tribal) . .	947	952	970	827	955	1,033	857
28. Teli	968	1,012	888	898	1,023	966	1,003
<i>Muslim.</i>							
29. Jolaha	983	1,031	1,096	1,184	968	903	865
30. Pathan	873	1,024	908	810	894	825	783
31. Sheikh	890	1,041	878	845	915	844	833

APPENDIX.

Size and Sex constitution of families.

An attempt has been made for the first time in this Census to collect information as to rates of fertility and mortality and size and sex constitution of families in the Central India Agency. It is obviously impossible to obtain this kind of information through the ordinary enumeration agency. Even the medical department is not a suitable medium for the collection of such information. There is a complete lack of public societies and organizations working for social welfare in Central India whose assistance could have been invoked in this matter. For these reasons it has not been possible to secure a sufficient number of returns to be useful for any conclusive inferences.

2. The information was collected in the form prescribed by the Census Commissioner for India which contained the following heads of enquiry :—

1. Age.
2. Husband's age.
3. Husband's occupation and caste or religion.
4. Duration of married life (*i.e.*, number of years since commencement of co-habitation).
5. Sex of first child (whether quick or still born).
6. Number of children born alive.
7. Number of children still living.
8. Ages of children still living.

About 5,000 returns in all were collected through the courtesy of the Census Officers of Dhar and Bhopal and the Chief Medical Officer in Central India. Some of these had to be ignored in compiling each table owing to defective record under some head or other. The highest number of slips which could be dealt with for any one of the tables was 4,380 which is too small to be of any practical value for analytical purposes and this value is further diminished by the following considerations :—

- (1) Age returns (specially in case of females) are not reliable.
- (2) The duration of married life may in some cases have been counted from the date of formal marriage instead of from the period of commencement of co-habitation.
- (3) Children born alive but dying soon after birth may have been omitted.

3. The results of the enquiry are exhibited in the tables that follow without any detailed discussion of the statistics. Few very brief and general points may however be mentioned. The figures indicate a preponderance of males at the first birth, the ratio being 732 females to 1,000 males. The average number of children born alive is 4 per family. Omitting the occupations for which less than 10 families were examined, the traders show the highest average (5) and the scavengers and sweepers the lowest (2). Considered in relation to caste, the Bohras, a trading class among the Muslims appear to be the most prolific with an average of 7 children born alive per family. Ahirs, Kurmis and Patlias (a section of the Bhils) with an average of 5 come next. With reference to the age of wife at marriage, the families with wife married between the ages of 13 and 19 years show a lower average than those with wife married at a later age. These figures, however, do not refer exclusively to completed fertility cases and cannot therefore be true index of the size of families. The percentage proportion of sterile marriages in relation to the wife's age at marriage works out as follows :—

Age of marriage.	DURATION OF MARRIED LIFE.			
	0—4.	5—9.	10—14.	15 and over.
1	2	3	4	5
13—14 . . .	54	9	5	5
15—19 . . .	43	10	9	3
20—30 . . .	26	9	9	7
30 and over . .	28	44	10	10

SEX TABLE I.—*Sex of First Born.*

Locality.	Number of females first born.	Number of males first born.	Number of females first born per 1,000 males first born.	Number of slips examined.
1	2	3	4	5
CENTRAL INDIA AGENCY	1,543	2,107	732	4,374
Indore Residency	14	16	875	30
Dhar	1,063	1,439	727	3,007
Nowgong	40	71	563	152
Malwa Bhil Corps	74	90	822	235
Bhopal	352	491	717	950

NOTE.—Slips in which Sex of the first born was not given were ignored.

SEX TABLE III.—*Size of families by occupation of husband.*

Sub-class No.	Occupation of husband.	No. of families examined.	Total No. of children born alive.	Average per family.	No. of children surviving.	Proportion of surviving to total 1,000 born.
1	2	3	4	5	6	7
	CENTRAL INDIA AGENCY	4,362	15,416	4	9,790	635
I	Exploitation of animals and vegetation.	154	509	3	298	585
	1. Non-cultivating Proprietors	1	2	2	2	1,000
	2. Tenant cultivators	143	466	3	275	590
	3. Raisers of live stock, milkmen, herdsman and fishermen.	10	41	4	21	512
III	Industry	156	517	3	312	603
	1. Artisans and other workmen	146	501	3	304	607
	2. Scavengers and sweepers	10	16	2	8	500
IV	Transport	9	31	3	22	710
	Bullock cart and other vehicles drivers.	9	31	3	22	710
V	Trade	142	675	5	437	647
VI	Public Force	166	505	3	392	776
	1. Army (Malwa Bhil Corps)	164	492	3	387	787
	2. Police (Village Watchmen).	2	13	7	5	385
VII	Public Administration	92	334	4	229	686
VIII	Professions and Liberal Arts	9	57	6	35	614
	1. Religions	2	8	4	6	750
	2. Law, Medicine and Instruction.	7	49	7	29	592
IX	Persons living on their income	1	11	11	5	455
X	Domestic Service	102	329	3	191	581
XI	Insufficiently described occupation	47	137	3	86	628
	1. Contractors, Clerks, Cashiers, etc., otherwise unspecified.	2	1	1
	2. Labourers unspecified	45	136	3	86	632
XII	Unproductive (Beggars, Prisoners, etc.).	8	34	4	22	647
XIII	Occupation not returned	3,476	12,277	4	7,761	632

NOTE.—Slips in which occupation of husband was obscure or doubtful were ignored.

SEX TABLE IV.—*Size of Families by Caste or Religion of Family.*

Caste or Religion.	No. of Families examined.	Total No. of children born alive.	Average per Family.	No. of children surviving.	Proportion of surviving to 1,000 born.	NO. OF FAMILIES WITH WIFE MARRIED AT			
						13—14.	15—19.	20—30.	30 and over.
1	2	3	4	5	6	7	8	9	10
CENTRAL INDIA AGENCY.	4,380	15,223	3	8,373	550	1,045	1,484	523	103
Ahir . . .	57	261	5	157	602	18	23	8	2
Balai . . .	88	289	3	186	644	13	27	15	2
Bania . . .	148	550	4	317	576	55	24	7	1
Banjara . . .	197	653	3	426	652	27	74	21	3
Bharud . . .	94	303	3	176	581	33	27	18	3
Bhil . . .	396	1,006	3	745	741	83	191	40	5
Bhilala . . .	290	1,105	4	837	757	40	103	63	8
Bohra . . .	52	346	7	184	532	23	21	3	..
Brahman . . .	175	613	4	369	602	35	59	5	..
Chamar . . .	101	382	4	217	568	13	54	8	2
Dangi . . .	94	261	3	166	636	16	20	10	1
Dhakad . . .	66	235	4	155	660	15	5	3	1
Gaoli (Gwal) . . .	108	260	2	193	742	22	34	9	1
Kachhi . . .	58	222	4	85	383	46	9	13	7
Korku . . .	356	959	3	576	601	70	155	27	3
Kurmi . . .	89	482	5	174	361	65	12	3	2
Mankar . . .	111	428	4	252	589	22	55	12	1
Mewati . . .	77	249	3	185	743	18	26	5	2
Muslim . . .	297	1,279	4	902	705	67	78	113	32
Patlia . . .	58	275	5	175	636	21	20	6	..
Rajput . . .	259	795	3	599	753	54	89	15	7
Sirvi . . .	168	565	3	301	533	44	69	20	2
Unspecified . . .	289	1,085	4	669	617	60	85	36	2
Others . . .	752	2,620	3	327	129	185	224	63	16

SEX TABLE V.—*Average size of Family correlated with Age of Wife at marriage.*

Age of wife at marriage.	Number of families.	Number of children born alive.	Average per family observed.	Number of children surviving.	Average per family observed.
1	2	3	4	5	6
CENTRAL INDIA AGENCY . . .	2,478	8,462	8	5,853	2
13—14	772	2,374	3	1,548	2
15—19	1,272	4,414	3	2,949	2
20—30	387	1,505	4	1,063	3
30 and over	47	169	4	93	2

NOTE.—Slips in which either marriage age was below 13—14 are omitted altogether and also in which either the number of children born alive or number of surviving children was not given were ignored.

SEX TABLE VI.—Proportion of fertile and sterile marriage.

Age of wife at marriage.	DURATION OF MARRIAGE YEARS.							
	0—4.		5—9.		10—14.		15 and over.	
	Fertile.	Sterile.	Fertile.	Sterile.	Fertile.	Sterile.	Fertile.	Sterile.
1	2	3	4	5	6	7	8	9
CENTRAL INDIA AGENCY.	257	213	523	59	568	46	1,245	60
13—14	83	99	221	21	211	12	366	20
15—19	132	99	233	25	277	26	672	24
20—30	37	13	60	6	71	7	188	14
30 and over	5	2	9	7	9	1	19	2

NOTE.—Slips in which duration of married life was not given have been ignored.

SEX TABLE VII.—Duration of marriage correlated with Caste or Religion of Family.

Caste or Religion of husband.	DURATION OF MARRIAGE WITH PRESENT WIFE.																	
	Under 10 years.			10 years.			10—19.			20—31.			32.			33 and over.		
	No. of families.	No. of children.	Average No. of children.	No. of families.	No. of children.	Average No. of children.	No. of families.	No. of children.	Average No. of children.	No. of families.	No. of children.	Average No. of children.	No. of families.	No. of children.	Average No. of children.	No. of families.	No. of children.	Average No. of children.
1	2	3	4	5	6	7	8	9	10	11	12	13	14	15	16	17	18	19
CENTRAL INDIA AGENCY.	1,416	1,967	1	377	1,013	3	1,205	4,701	4	1,006	5,205	5	35	178	5	341	2,159	6
Ahir	12	18	2	5	15	3	27	135	5	10	68	7	3	25	8
Balai	29	34	1	9	34	4	19	75	4	28	134	5	1	4	4	2	8	4
Bania	46	66	1	10	26	3	42	166	4	37	213	6	2	17	9	11	62	6
Banjara	71	104	1	14	30	2	41	158	4	51	256	5	6	21	4	14	84	6
Bharud	30	37	1	8	22	3	24	70	3	26	127	5	1	5	5	5	42	8
Bhil	179	213	1	41	114	3	110	370	3	38	146	4	1	8	8	27	155	6
Bhilala	82	148	2	30	109	4	95	453	5	63	237	4	20	158	8
Bohra	8	23	3	3	16	5	19	110	6	12	83	7	10	114	11
Brahman	61	59	1	5	11	2	45	165	4	37	225	6	1	6	6	26	147	6
Chamar	44	57	1	3	8	3	22	107	5	24	163	7	8	47	6
Dangi	35	37	1	12	36	3	22	74	3	19	94	5	2	10	5	4	10	3
Dhakad	9	15	2	6	14	2	21	67	3	22	100	5	8	39	5
Gaoli (Gwal)	48	49	1	9	24	3	24	50	3	18	69	4	9	68	8
Kachhi	17	30	2	2	6	3	17	71	4	16	85	5	2	10	5	4	20	5
Korku	139	180	1	27	59	2	69	233	3	89	389	4	32	118	4
Kurmi	20	46	2	5	17	3	31	141	5	25	186	7	8	92	12
Mankar	34	58	2	11	32	3	26	102	4	29	130	4	1	10	10	10	96	10
Mewati	30	65	2	15	45	3	17	62	4	15	77	5
Muslim	79	136	2	20	55	3	101	449	4	74	477	6	3	21	7	20	141	7
Patlia	12	17	1	3	13	4	16	73	5	19	121	6	3	21	7	5	30	6
Rajput	82	95	1	23	62	3	59	179	3	56	244	4	3	3	1	36	212	6
Sirvi	72	97	1	12	22	2	36	142	4	36	220	6	1	1	1	11	83	8
Unspecified	66	92	1	22	37	2	105	413	4	73	416	6	1	3	3	22	124	6
Others	211	291	1	82	206	3	217	836	4	189	945	5	7	38	5	46	284	6

CHAPTER VI.

Civil Condition.

103. **The basis of the figures.**—For the purposes of this chapter the whole population is divided into three classes, *viz.*, unmarried, married and widowed. On the Enumeration Cover the following instruction was given :—

Column 6 (Married, etc.)—Enter each person, whether infant, child or grown up, as either married, unmarried or widowed. Divorced persons, who have not remarried, should be entered as widowed.

The Code contained the following amplified instructions :—

A woman who has never been married must be shown in column 6 as unmarried, even though she be a prostitute or concubine. Persons who are recognised by custom as married are to be entered as such even though they have not gone through the full ceremony, *e.g.*, widows who have taken a second husband by the rite known in some parts as *Pat, Natra, Nikah, Baithana, Dharjana*, etc., or persons living together whose religious or social tenets enjoin or allow cohabitation without preliminary formalities.

Here and there some women living in loose relationship might have returned themselves as married. This scarcely affects the figures which may be accepted as accurate for all purposes. The term married as applied to Indian conditions requires an explanation. Owing to the custom of early marriage in the bulk of the population marriage in pre-puberty stage is merely an irrevocable betrothal. The girl stays with her parents after the religious ceremony and she joins her husband's home after attaining puberty. Generally there is a second ceremony before she is initiated into the duties of matrimony. In later or post-puberty marriages the term marriage approximates to the married state. The term widowed is inclusive of divorced persons who have not re-married.

104. **Introductory.**—Marriage is the very basis and foundation of human society in primitive and advanced cultures. In the biological side it is the desire for mating and parenthood and sanction and approval of the community are obtained for such a wish by going through recognised legal or ritualistic or sacramental formalities. The latter constitute an important and essential element and are universally preceded by betrothal—a preliminary act to marriage. The most prevalent type of marriage is patrilocal in which the bride moves to her husband's community and takes up a residence in a home set up by her husband. Matrilocality in which the husband joins the community of his wife and often renders service for her parents during a stipulated period, is prevalent among certain castes in Central India and is known as the custom of *ghar-jamai*.¹ Apart from territorial or racial limits, the institution of marriage is hedged round with three restrictions—endogamy, exogamy and hypergamy. The Indian caste endogamy and exogamy are well known and familiar. The exogamous subdivision denotes a group from within which its male members cannot take their wives. The law of endogamy prevents a man or woman from marrying outside his or her social group. Hypergamy is not universal in its operation. It is restricted to Rajputs and to few castes only. It permits a man to marry a woman of an inferior section but a girl is obliged to marry in her or preferably higher section and on no account into a lower one. The norm of marriage that prevails in overwhelming numbers is of course monogamy. Polygamy and polyandry are but variants of monogamy and the various customs of extra-connubial liberties and sexual licenses should be viewed primarily in relation to monogamous marriage as an institution.

“ Monogamy as pattern and prototype of human marriage is universal. The whole institution, in its sexual, parental, economic, legal and religious aspects, is founded on the fact that the real function of marriage—sexual union, production and care of children, and the co-operation which it implies—requires essentially two people, and two people only, and that in the overwhelming majority of cases, two people only are united in order to fulfil these facts.

Conjugation necessarily takes place only between these two organisms; children are produced by two parents only, and always socially regarded as the off-spring of one couple; the economics of the household are never conducted group-wise; the legal contract is never entered upon jointly; the religious sanction is given only to the union of two. A form of marriage based on communism in sex, joint parenthood, domesticity, group contract, and a promiscuous sacrament has never been described. Monogamy is, has been and will remain the only true type of marriage. To place polygyny and polyandry as ‘ forms of marriage ’ co-ordinate with monogamy is erroneous.”²

¹ See Appendix to this Chapter.

² For a treatment of the question of marriage from the standpoint of functional anthropology, see the article on Marriage by Bronislaw Malinowski in the *Encyclopædia Britannica*, 14th Edition, from which this extract is taken.

105. **Main statistics.**—In Imperial Table VII will be found the statistics for age, sex and civil condition and table VIII furnishes the same information for certain selected castes. At the end of this chapter, the following five Subsidiary Tables will be found :—

- I.—Distribution by Civil Condition of 1,000 of each Sex, Religion and main Age-period at each of the last five Censuses.
- II.—Distribution by Civil Condition of 1,000 of each Sex at certain ages in each Religion and Natural Division.
- III.—Distribution by main Age-periods and Civil Condition of 10,000 of each Sex and Religion.
- IV.—Proportion of the Sexes by Civil Condition at certain ages for Religions and Natural Divisions.
- V.—Distribution by Civil Condition of 1,000 of each Sex at certain ages for Selected Castes.

They show, what has now become a commonplace in the statistics of Indian civil condition, three features *viz.*—

- (a) universality of marriage,
- (b) early marriage and
- (c) high proportion of widows.

106. **Universality of marriage.**—In Central India 444 males per mille and 331 females per mille are unmarried. The proportion in each of the civil conditions by quinquennial age-periods is given in the table below. The diagram shows the distribution in age-periods given in Subsidiary Table I.

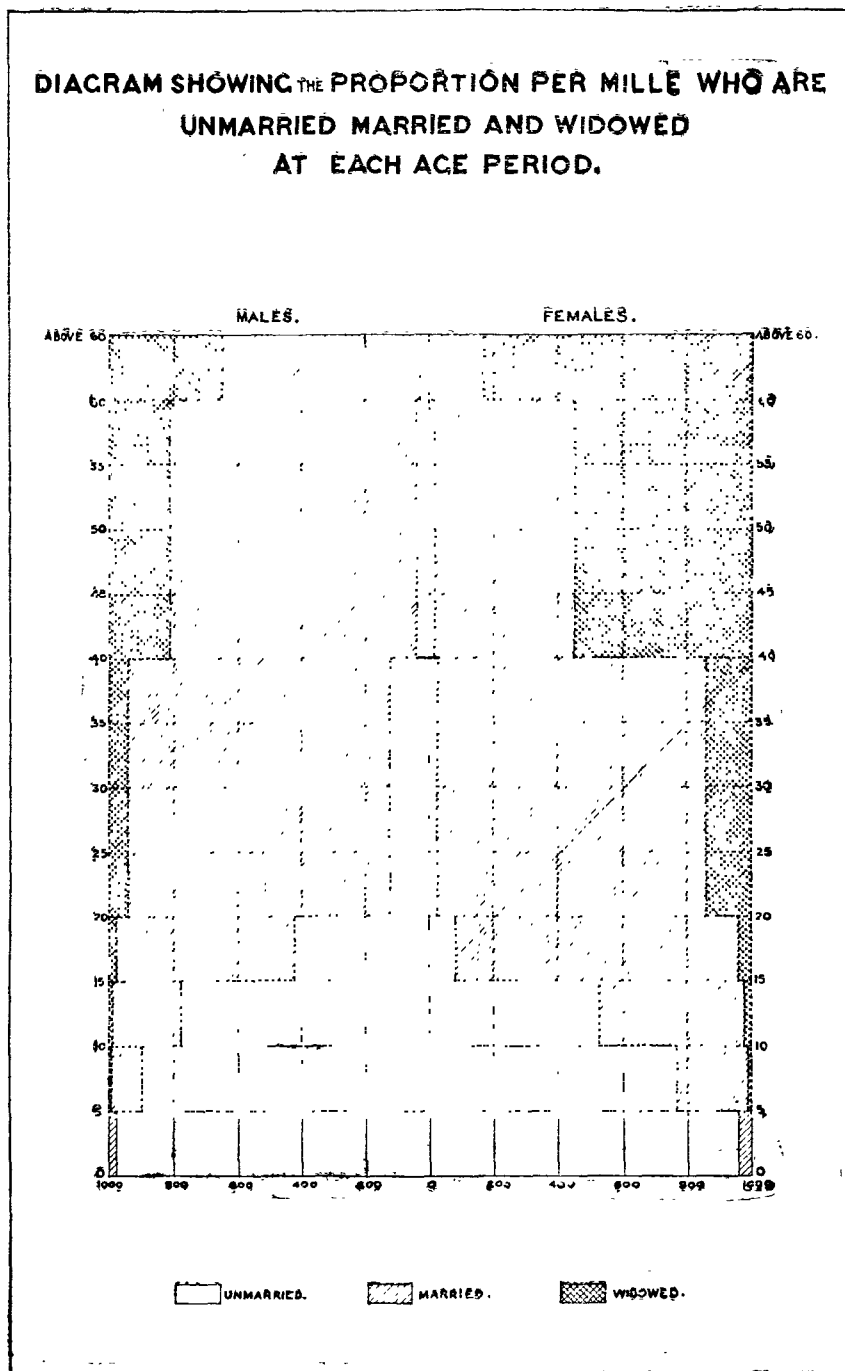

Distribution by Civil Condition of 1,000 of each Sex in each age-period.

Age.	PER 1,000 IN AGE-PERIODS.					
	Unmarried.		Married.		Widowed.	
	Males.	Females.	Males.	Females.	Males.	Females.
1	2	3	4	5	6	7
0—5. . .	981	970	18	29	1	1
5—10 . . .	895	771	102	223	3	6
10—15 . . .	780	529	214	460	6	11
15—20 . . .	420	86	560	882	20	32
20—25 . . .	245	35	724	916	31	49
25—30 . . .	103	24	846	876	51	100
30—35 . . .	74	23	859	828	67	149
35—40 . . .	54	15	838	683	108	302
40—45 . . .	48	14	817	601	135	385
45—50 . . .	40	14	773	427	187	559
50—55 . . .	36	12	750	361	214	627
55—60 . . .	32	7	688	232	280	761

In the total population nearly one-half is married, 39 per cent. are unmarried and the remaining 11 per cent. are widowed. 49 per cent. of the males and 51 per cent. of the females are married and 6 per cent. of males and 15 per cent. of females are widowed. When the age-periods are examined, there are 29 per mille girls below 5 who are married and already one in a thousand has become a widow, never perhaps likely to get married again. Before the age of 20 only 9 per hundred amongst females are left unmarried. The rest are either married or widowed. By the age of 30, both among males and females, few are left unmarried. At the age of 40, there is only one spinster left in a hundred.

This universality of marriage is nothing that is peculiar to India. As was pointed out in the 1911 India Report 'it is only in the artificial and economic conditions of the West that marriage has ceased to be regarded as inevitable, and that prudential and other considerations cause many to remain celibate'. According to Westernmarck 'marriage is rooted in the family rather than family in marriage'. In all communities, whether Hindu, Muslim or Tribal the desire to get married and have children is a natural instinct and a wife in many classes is of an economic necessity. It is not the universality of marriage in India that is interesting or even alarming. It is the consequences that flow from it that have always attracted the attention of and invited criticisms—sometimes just and sometimes uncharitable—by the observers of Indian social conditions. They will be dealt with when we come to child marriages and the condition of the widowed.

107. Early age of marriage.—A second feature emphasised by the diagram and the figures is the early age at which the marriage takes place. Below the age of 5, nearly 3 per cent. of the girls are already married. Below 20 the figures are striking. 19 per cent. of males and 34 per cent. of females are in a married state. Below 30 nearly 50 per cent. of the females are married. Below the age of 5, 8,796 boys and 14,738 girls are married. In many lower castes marriages in childhood are common and amongst all classes of Hindus pre-puberty marriage before the ages of 12 or 13 is the general practice. Amongst certain sections of the Muslims and few advanced communities marriages take place shortly after puberty. Early marriage is generally the rule and later marriage the exception.

108. High proportion of widows.—The disparity in numbers between the widowers and the widows is at once noticeable. Custom decrees a widower can marry but a widow cannot. Early marriage adversely affects the females because on being widowed they cannot remarry. Then the disparity in marriage ages results in the higher proportions of widows. Widow re-marriage is taboo in the upper Hindu classes. The lower elements in Hindu society resort to widow marriages but such of those who wish to rise up in the social ladder eschew widow re-marriage as a badge of respectability. The figures show that 720 girls under the age of 5, before they have understood what life is, have become widows. Before the age of 10, 6 girls in a thousand have become widows. At the prime of life, below 25, every twentieth woman in a hundred is a widow.

DISTRIBUTION OF 1,000 OF EACH SEX IN EACH MAIN RELIGION BY FOUR AGE PERIODS

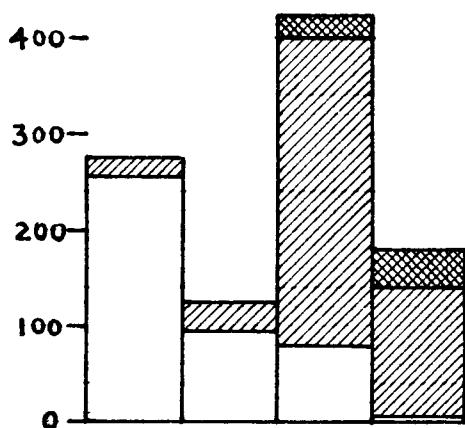

HINDU MALES

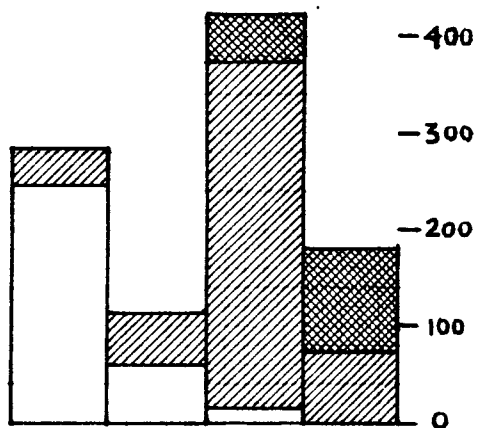

HINDU FEMALES

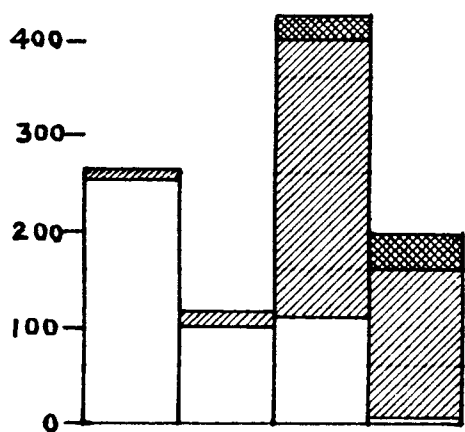

MUSLIM MALES

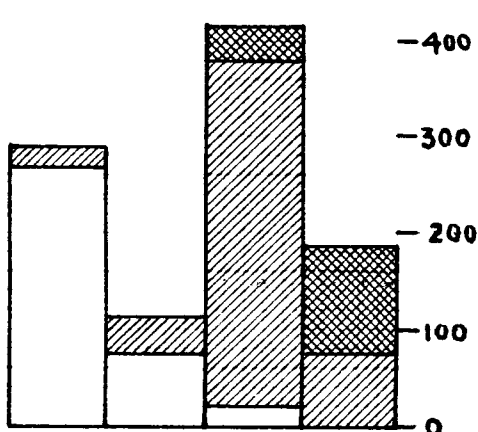

MUSLIM FEMALES

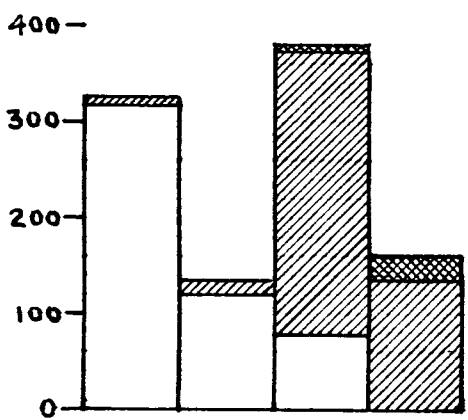

TRIBAL MALES

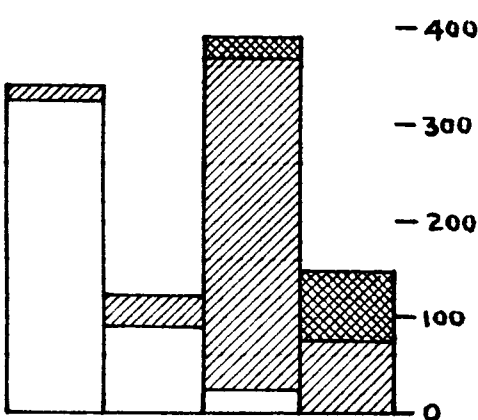

TRIBAL FEMALES



JAIN MALES

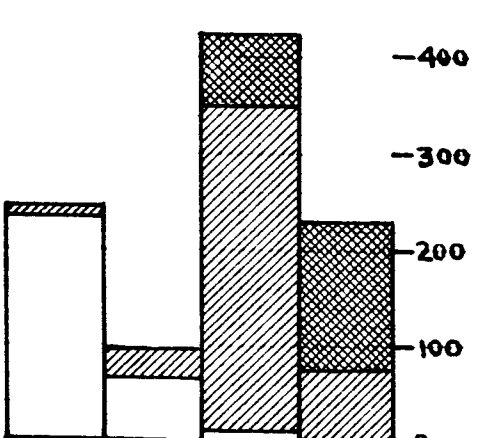

JAIN FEMALES

UNMARRIED
 MARRIED
 WIDOWED

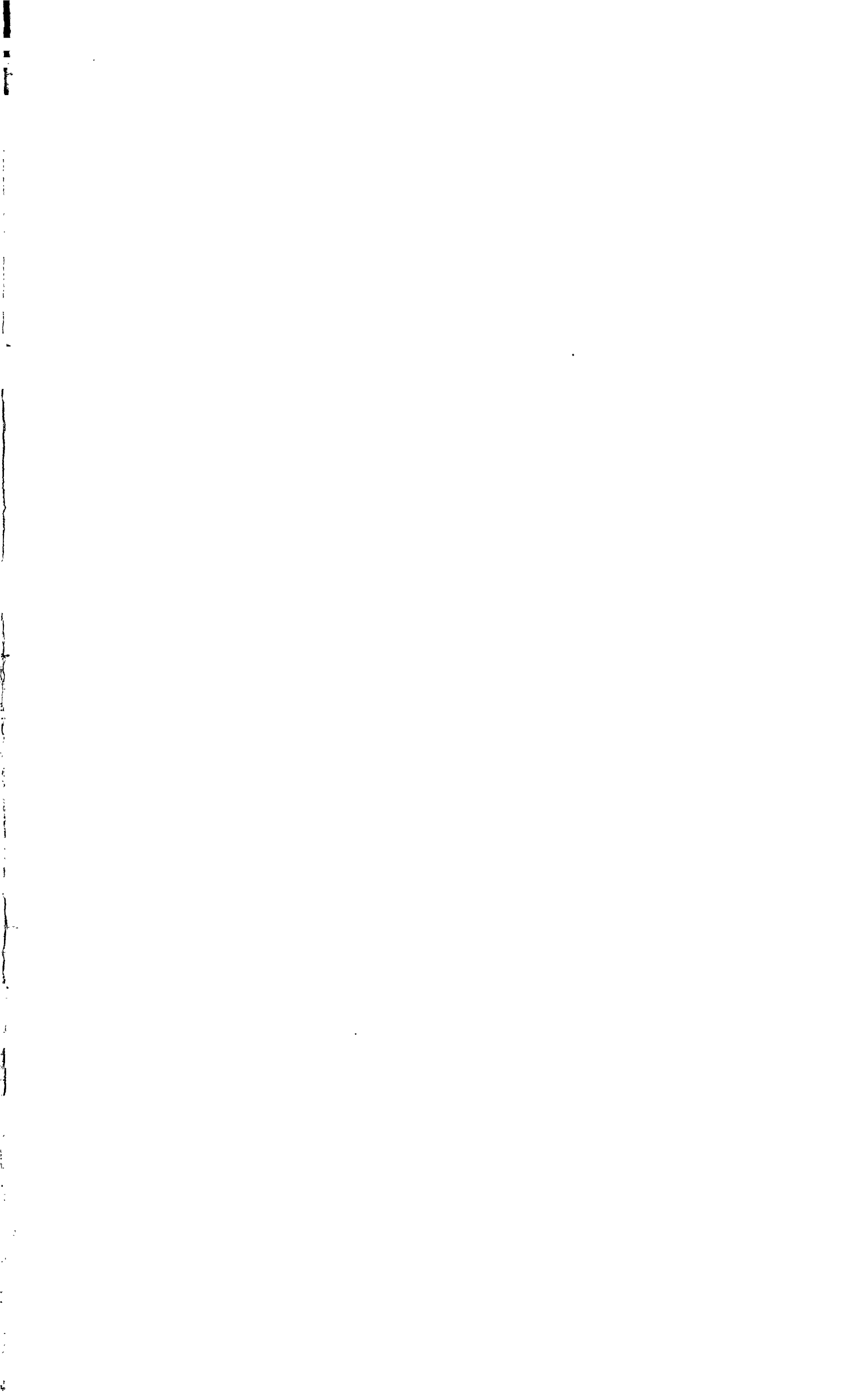

DISTRIBUTION OF 1000 OF EACH SEX IN EACH MAIN RELIGION BY CIVIL CONDITION

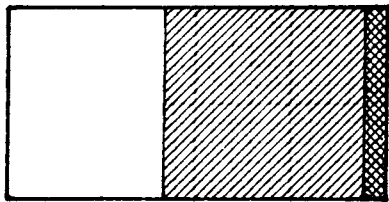

HINDU MALES

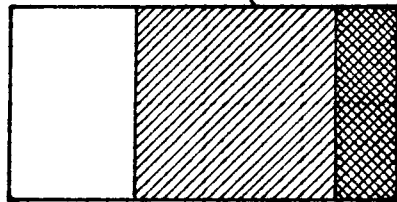

HINDU FEMALES

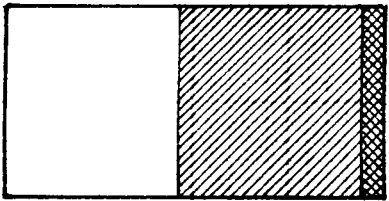

MUSLIM MALES

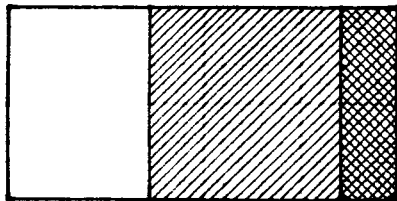

MUSLIM FEMALES

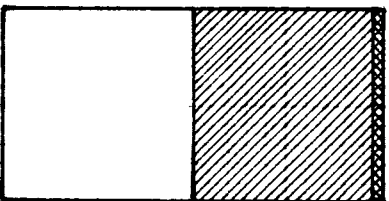

TRIBAL MALES

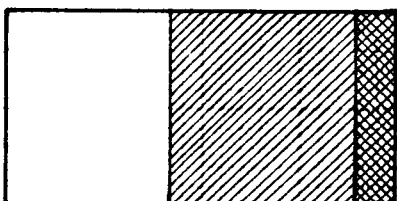

TRIBAL FEMALES

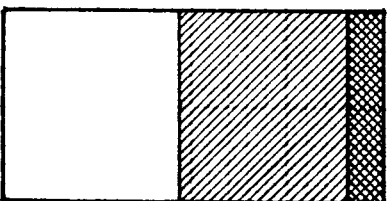

JAIN MALES

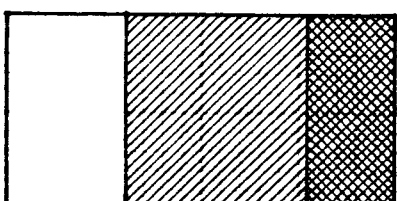

JAIN FEMALES

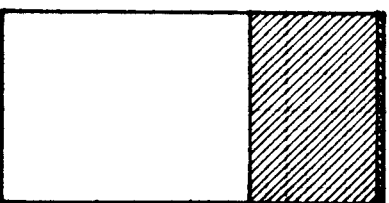

CHRISTIAN MALES

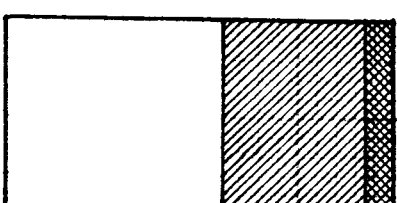

CHRISTIAN FEMALES

UNMARRIED

MARRIED

WIDOWED

109. **Civil Condition in different Religions.**—The universality of marriage is again seen when we analyse the civil condition by different religions. The

Unmarried at age 40—60 by Religion.

Religion.	NUMBER PER MILLE AGED 40—60 WHO ARE UNMARRIED.	
	Males.	Females.
1	2	3
All Religions	41	13
Hindu	43	13
Muslim	27	13
Tribal	15	9
Jain	102	6
Christian	96	105

The Christian population contains a large European element and it may be ignored. The Jains alone have 102 males per mille who are unmarried. The celibacy practised by certain Jain sects possibly accounts for this comparatively high proportion. The female proportion is in accordance with that of the other religious communities. The primitive tribes have the least proportion of unmarried males and females. The Hindu proportion would be still lower but for the wandering beggars, *sadhuis*, *bairagis* and such other miscellaneous population who have no settled home and

do not generally enter into wedlock.

The distribution of each of the three civil conditions in the different religions in each sex is shown in the diagrams opposite. One noticeable feature therein is the close approximation of Muslim civil condition to that of the Hindus. This is evidently due to the Hindu influences on the Muslim population more especially in the rural parts. The Tribal groups alone have a larger element of unmarried persons. The Hindu and Muslim widows are 159 and 146 per mille while the followers of Tribal religion have 102. When the age-periods are examined, the attitude of each religious community towards marriage is brought out as the figures given in the margin show. The Hindus marry early but the Muslims and

Married at certain age-periods by Religion.

Age.	NUMBER OF MARRIED PER MILLE.					
	Hindu.		Muslim.		Tribal.	
	Males.	Females.	Males.	Females.	Males.	Females.
1	2	3	4	5	6	7
0—5	19	31	10	18	8	9
5—10	108	240	66	133	49	84
10—15	227	481	125	334	123	269
15—20	576	888	416	855	488	817
20—30	790	894	709	919	805	929
30—40	848	756	855	805	896	839

the Tribals do not altogether discard early marriage. In the age below 10, the Hindu female proportion is twice that of the Muslims and thrice that of the Tribals. By 20 the proportion of female in all the three is nearly equal. The Tribals marry later than the Hindus and the Muslims. This

tendency towards a later marriage amongst the Muslims and the Tribals is only noticeable below 15. After that age it is not so pronounced. Turning to the proportion of widows among these three religions, we find that the Tribals have the lowest proportion in the three age-periods shown in the table. Though the Muslims have fewer widows compared with the Hindus yet

Widowed at certain age-periods by Religion.

Age.	NUMBER OF WIDOWED PER MILLE.					
	Hindu.		Muslim.		Tribal.	
	Males.	Females.	Males.	Females.	Males.	Females.
1	2	3	4	5	6	7
15—20	21	34	19	23	16	16
20—40	61	140	62	105	46	86
40—60	190	544	169	522	128	445

their proportion is fairly high and at the higher ages it approximates to that of the Hindus. The Hindus constitute more than 88 per cent. of the total population in Central India and the three main characteristics of civil condition enumerated above *viz.*, universal-

ity of marriage, early marriage and a larger proportion of widows are strikingly brought out in the statistics which are in main influenced by them. The Muslims only appear to maintain a seeming difference; they share more of the Hindu characteristics and they do not influence the statistics materially. The Tribals do by their strong deviation from certain Hindu customs, though they too are coloured by the all-pervading effect of Hinduism.

110. **Early marriage.**—In the India Report of 1911 it was shown that Central India is one of the areas where the custom of child marriages is prevalent and that whereas in the Central Provinces, Rajputana and the United Provinces the castes most addicted to infant marriages also belong to the lower social strata an exception to this general rule occurs in Central India where infant marriage is common amongst the Brahmans, the Rajputs taking the second place. In 1921 the All-India figures showed that in the period 0—5, 6 boys and 11 girls per mille of each were married and 32 and 88 respectively in the period 5—10.

In Central India 18 boys and 29 girls per mille of each sex are married in the period 0—5 and 102 and 223 respectively in the period 5—10. The corresponding figures for the Hindus are 19 and 31 in the period 0—5 and 108 and 240 in the period 5—10. The figures for the Hindus are therefore slightly higher than the general proportions and it is in them the custom of child marriage is widely prevalent. The number for Muslim and Tribal is much smaller as will be seen from the inset table in paragraph 109 above.

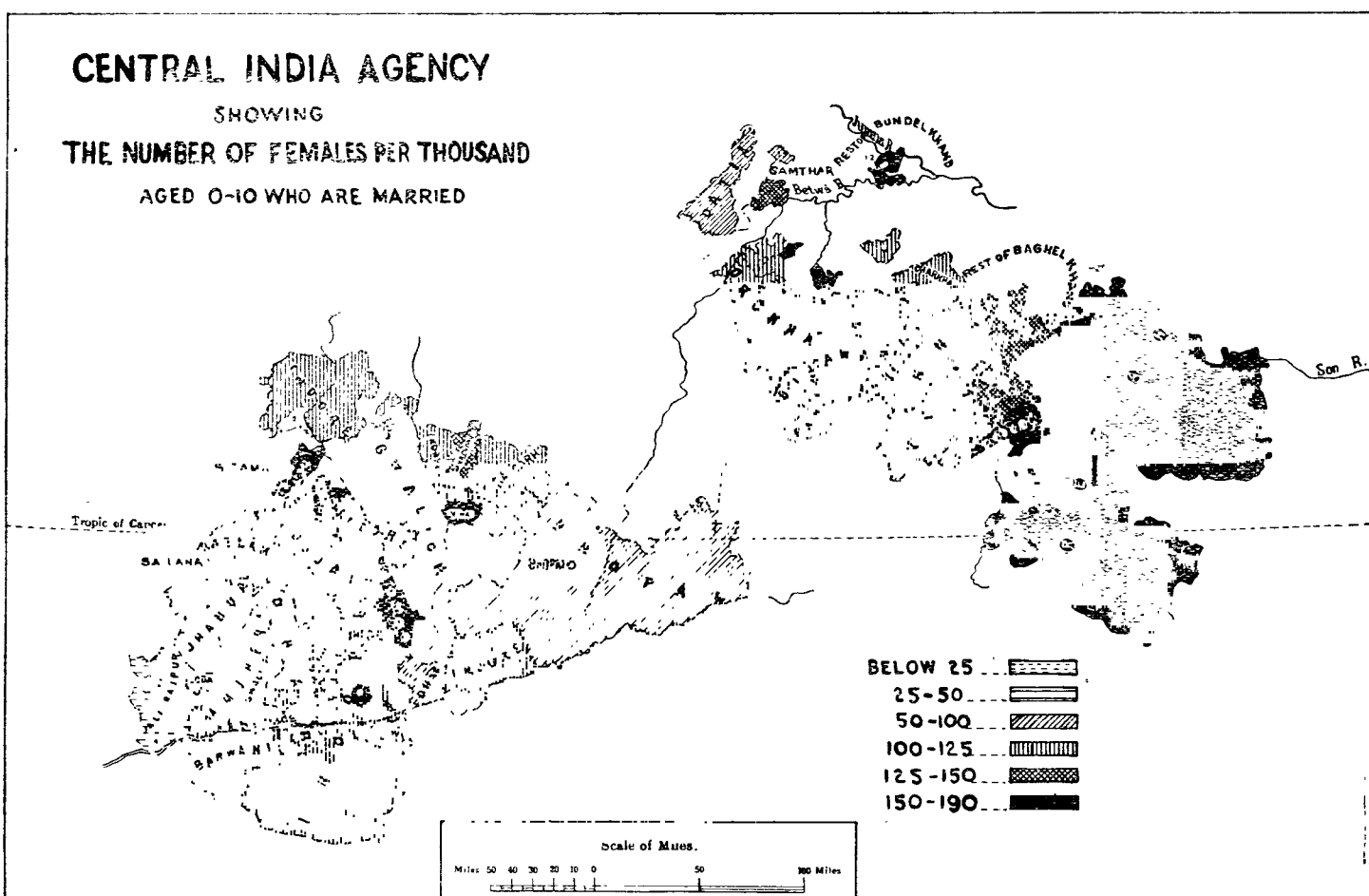

The prevalence of early marriage by locality is shown in the map. The number of girls married or widowed per 1,000 aged less than 10 in the principal States is given in the margin. The territorial distribution reveals certain interesting features.

Number of girls below ten married or widowed per 1,000.

State.	Proportion.	State.	Proportion.
1	2	1	2
Central India Agency	119	Ajaigarh	110
Jaora	197	Bijawar	109
Sitamau	177	Chhatarpur	105
Dewas (Senior and Junior)	165	Orchha	102
Rewa	159	Dhar	95
Maihar	154	Sailana	94
Nagod	143	Bhopal	94
Khilchipur	138	Datia	89
Samthar	132	Panna	88
Rajgarh	123	Ratlam	81
Narsinghgarh	119	Barwani	45
Charkhari	118	Jhabua	42
Indore	117	Ali-Rajpur	14

The proportions are higher in the central portion of Bundelkhand and the lowest are found in the farthest eastern tract of Panna and the farthest western tract of Datia. In the Western Division of Central India the western Malwa

principal States is given in the margin. The territorial distribution reveals certain interesting features. Taking the Eastern Division of the Agency, the incidence is highest in the States of Baghelkhand, *viz.*, Rewa (159), Maihar (154) and Nagod (143). There is a considerable drop in the Bundelkhand tract.

States show a very high proportion closely followed by the northern Malwa tracts. Indore, Dhar and Bhopal occupy an intermediate position. The most striking things are the proportions in the Bhil tracts of Ali Rajpur, Jhabua and Barwani where they are the lowest. Here the Tribal custom has successfully countervailed against the orthodox Hindu system. One clue to these variations may be found in the distribution of certain castes in the different localities. The caste composition in the East and West varies to a great extent. The Sarwaria Brahmans who form about 47 per cent. of the total Brahman population in Central India are mainly concentrated in Rewa and other Baghelkhand States. The Jijhotia and Kanaujia Brahmans are found in Bundelkhand. Some castes like Telis and Balais who specialise in early marriages are concentrated differently. The former are largely concentrated in Baghelkhand and the latter in Malwa. Another caste Kurmi which has a reputation for child marriage is concentrated in Baghelkhand whereas Lodhis are mainly found in Malwa and Bundelkhand.

In Malwa the variations are understandable according to the regional grouping. In Bhopal the Muslim element keeps down the proportion but this curiously is in contradistinction to Jaora which has the highest proportion. Indore has considerable urban population and a section of this population is influenced by the modern progressive ideas regarding early marriage. The Tribal figures have also some influence in localities like Indore, Dhar, Sailana and Ratlam and this influence is more markedly brought out on the figures for Barwani, Ali-Rajpur and Jhabua where the incidence is the least.

111. Early Marriage and Caste.—This leads to the prevalence of early marriage in different castes. Subsidiary Table V gives the figures for different

Proportion of married and widowed at certain ages by Caste.

Caste.	NUMBER PER 1,000 MARRIED AND WIDOWED.			
	Males.		Females.	
	0—6.	7—13.	0—6.	7—13.
1	2	3	4	5
<i>A.—High figures.</i>				
Kurmi	107	418	151	605
Teli	50	301	83	481
Gadaria	28	301	60	521
Jolaha (Muslim)	31	359	53	543
Balai	17	143	34	457
Dhobi	22	172	36	395
Gujar	26	186	44	457
Sondhia	14	154	32	438
Basor	37	225	52	401
Ahir	22	184	63	398
Koli	26	202	41	395
Jat	26	142	41	371
Lodhi	10	132	32	362
Kachhi	22	170	37	359
Brahman	16	149	33	313
Bania	14	135	38	301
<i>B.—Low figures.</i>				
Rajput	17	75	42	249
Gond	17	116	26	242
Mehtar	21	116	30	227
Chamar	22	183	48	213
Baiga	14	87	18	170
Sheikh	11	73	18	176
Pathan	9	45	14	150
Kayastha	17	36	24	147
Bhil	8	60	9	140
Banjara	15	36	13	134

castes and the marginal table is prepared by extracting the figures from it and arranging them in two categories—high figures and low figures—for purposes of contrast. In class A the lead is taken by cultivating castes like Kurmi and Gadaria, followed by other cultivating castes like Ahir, Gujar, Jat, Kachhi and Lodhi. The depressed castes of Balai and Basor have high proportions but the Chamar surprisingly has not. The Brahmans and the Baniyas have the lowest female proportion of married in the age-period 7—13 in this group. The effect of Hindu influence is seen in the figures for Jolahas which stand in contrast to those for Pathans and Sheikhs. In class B, the Tribal groups like Gond, Baiga and Bhil have lower proportions, showing they are still resisting this aspect of Hinduisation. The depressed castes of Chamar and Mehtar are evidently more advanced than Balai and Basor. In the light of the above analysis, the conclusion stated in the India Report for 1911 needs an amendment. It is possible owing to the inclusion of Gwalior figures in the Central India Agency the position stated represented the facts as they then were.

We should now say that child marriage is prevalent to a high degree in Central India and that it is common amongst the good agricultural and cultivating castes and also in some of the lower castes. The Brahmans and the Rajputs occupy an intermediate position and the primitive tribes are comparatively least addicted to the customs of child marriage.

General Remarks.—On a calculation¹ it is found that about 52 per cent. of girls under the age of 15 are affected or likely to be affected by the prevalence of early marriage in Central India. In the absence of comparative figures prior to 1921 Census, it is not possible to say whether there has been a progressive rise

¹ Report of the Age of Consent Committee, para. 221.

in the age of marriage. The figures for the decade in the early age groups show no such indication. The practice in fact seems to be growing stronger. This is what is to be expected. Nothing but economic stress or visitation of any calamities would tend to postpone marriage in these parts. Such factors like education or modern ideas towards matrimony touch but a very minute fraction of the population. The masses are little affected by any such influences. In few urban centres and certain advanced classes of the migrant population in the States here and there, there may be a desire to postpone marriages to a later age. There is a great hiatus between this urban class and the indigenous rural population.

As is well-known though there is early marriage, it does not mean that there is an effective marital life. Certain customs which are designated by different names in different localities operate in a way to defer the consummation of marriage. According to the report of the Age of Consent Committee which investigated into the problem of child marriage in British India it is stated that deferred consummation rarely acts as a check and early consummation is the general practice. The injunction of Brahmans, the impatience on the part of elderly widowers who marry young girls, the anxiety of the parents to hand over the girl to her husband in case he is going wrong or due to poverty and the disintegration of the joint family system and the consequent weakening of check it once imposed—these are some of the causes advanced to show that early consummation is the common practice. They are in general applicable to these parts also.

The orthodox and conservative section of Hindu society sees nothing wrong in early marriage which, to them, is an institution that has been sanctified by custom, usage and tradition. To the more advanced it is an abhorrent practice in the modern times. Even in Europe the age of marriage for girls was considerably lower than what it is now. In the Renaissance period a large proportion of girls in Latin Countries were married at the age of 15 and even at an earlier age.¹ Among primitive people in different parts of the world girls are married habitually soon after puberty. Some would go so far as to say there is nothing inherently wrong in child marriages.

“In passing we may refer to the general and almost unchallenged assumption made by Europeans that the child marriages common among Oriental peoples must necessarily be held responsible for serious physical damage to the women, and adversely affect their future fertility. There appears, however, to be no evidence that child marriages nor even the custom of pre-nubile intercourse (common among Oceanic peoples) have any physically harmful consequences and the conviction of its harmfulness is in all probability a superstition arising from the same causes as the demand so passionately advocated in England by sexually dissatisfied women and sexually starved men that the female “age of consent” should again be postponed beyond the age fixed by the existing law.”²

The evils of child marriage however lie not in the institution as such but in its practical effects. Early cohabitation results in premature child births, many times in rapid succession. This does affect the health of the young and immature mother, seriously wrecking her constitution. In primitive societies, their organisation and well-accepted restrictions in marital life, mitigate the evil consequences of unrestricted mating. As Mr. Pitt-Rivers points out in a later section when dealing with the hygienic and eugenic aspects of polygyny that among the professedly monogamous people the essential dissimilarity of the male and female sexual cycle is habitually ignored.³ In India it is both ignored and not understood. We have no definite idea as to the working of early marriages in Hindu society in earlier times. In its disintegrating stage in modern times, every kind of check or restriction has either disappeared or has become nugatory. To seek merit in an institution whose effects are anything but good is to assess false values and to ignore the obvious. A proper approach to the problem of marriage—infant or adult—is from the standpoint of sex and a right attitude towards it on the social side and of a correct appreciation of the sexual factor from the biological side. Reformers oppressed with a sense of rapid progress would seek salvation in legislative enactments. While nobody denies that in a modern State, legislative aid is necessary in readjusting social maladjustments, legislation is only one of the means to an end.

¹ Pitt-Rivers. *The Clash of Culture and Contact of Races*, 117.

² *Ibid.*, foot-note.

³ *The Clash of Culture*, 128.

112. **The Widowed.**—A second consequence of early marriages is the number of young widows who have to remain in a widowed state all through their life. Coupled with the fact that there is a restriction to the remarriage of widows especially amongst the Hindu castes, we notice as the figures show a large proportion of widows. In a hundred of each sex, there are 6 widowers and 16 widows in Central India. The corresponding proportions in 1921 were 8 and 18. In the age-period 15—40, there are 112 widowed per mille. In the inset table the number of widows per mille in the main religions aged 15—40 for the 1921 and 1931 Censuses has been shown. In

Widows at 15—40 by Religion.

Religion.	NUMBER PER 1,000 WOMEN AGED 15—40 WHO ARE WIDOWED.	
	1931.	1921.
1	2	3
All Religions	112	126
Hindu	116	131
Muslim	86	100
Tribal	70	69
Jain	171	209

the ten years there has been a small

Widows at 24—43 by caste.

Caste.	PROPORTION PER MILLE OF FEMALES AGED 24—43 WHO ARE WIDOWED.
	1
	2
Brahman	298
Bania	273
Rajput	258
Kayastha	252
Kurmi	173
Gadaria	172
Teli	166
Basor	145
Gond	143
Baiga	116
Bhil	105

decrease in all the religions excepting the Tribals among whom there has been a very slight increase. The Jains lead in prohibiting the remarriage of their widows in the reproductive ages. From Subsidiary Table V it is apparent that the proportion of widows is greatest in the upper strata of Hindu society; those castes which observe the custom of early marriage have a lower proportion of widows as they in many cases resort to widow remarriage and the proportion of widows is least among the Tribal group. This is shown in the marginal table. Amongst the Jolahas who practise child marriage, the proportion of widows aged 24—43, is 153. The Sheikhs have the lowest—60.

SUBSIDIARY TABLE I.

Distribution by civil condition of 1,000 of each sex, religion and main age period.

Religion and Age.	UNMARRIED.				MARRIED.				WIDOWED.			
	Males.		Females.		Males.		Females.		Males.		Females.	
	1931.	1921.	1931.	1921.	1931.	1921.	1931.	1921.	1931.	1921.	1931.	1921.
1	2	3	4	5	6	7	8	9	10	11	12	13
All Religions . . .	444	461	331	335	495	464	513	488	61	75	156	177
0-5 . . .	981	984	970	974	18	15	29	24	1	1	1	2
5-10 . . .	895	947	771	866	102	49	223	126	3	4	6	8
10-15 . . .	780	775	529	464	214	214	460	513	6	11	11	23
15-20 . . .	420	514	86	117	560	460	882	837	20	26	32	46
20-40 . . .	128	151	25	22	812	763	839	834	60	86	136	144
40-60 . . .	41	51	13	13	773	766	448	470	186	183	539	517
60 and over . . .	32	49	8	15	619	608	159	149	349	343	833	836
Hindu . . .	438	454	323	324	500	469	518	494	62	77	159	182
0-5 . . .	980	983	967	971	19	16	31	26	1	1	2	3
5-10 . . .	889	942	754	852	108	54	240	140	3	4	6	8
10-15 . . .	766	757	506	431	227	231	481	544	7	12	13	25
15-20 . . .	403	491	78	102	576	482	888	850	21	27	34	48
20-40 . . .	124	148	25	20	815	763	835	830	61	89	140	150
40-60 . . .	43	53	13	12	767	760	443	464	190	187	544	524
60 and over . . .	34	51	8	14	613	599	159	146	353	350	833	840
Muslim . . .	467	464	363	355	471	461	491	476	62	75	146	169
0-5 . . .	989	988	981	978	10	11	18	20	1	1	1	2
5-10 . . .	932	968	863	920	66	29	133	72	2	3	4	8
10-15 . . .	871	886	659	629	125	107	334	356	4	7	7	15
15-20 . . .	565	668	122	143	416	314	855	825	19	18	23	2
20-40 . . .	167	184	24	33	771	741	871	852	62	75	105	15
40-60 . . .	27	40	13	23	804	790	465	492	169	170	522	45
60 and over . . .	18	36	10	25	653	645	138	148	329	319	852	87
Tribal . . .	511	542	438	466	450	415	460	427	39	43	102	17
0-5 . . .	992	993	991	991	8	6	9	8	..	1	..	1
5-10 . . .	950	985	914	970	49	14	84	27	1	1	2	3
10-15 . . .	874	916	727	776	123	80	269	215	3	4	4	9
15-20 . . .	496	697	167	329	488	290	817	651	16	13	16	20
20-40 . . .	108	124	23	32	846	816	891	889	46	60	86	79
40-60 . . .	15	28	9	18	857	860	546	597	128	112	445	385
60 and over . . .	10	35	7	15	729	726	213	209	261	239	780	75
Jain . . .	472	488	305	286	438	403	464	441	90	109	231	273
0-5 . . .	968	972	986	983	32	26	11	15	..	2	3	2
5-10 . . .	955	979	872	943	44	18	122	50	1	3	6	7
10-15 . . .	911	920	635	499	88	74	353	474	1	6	12	27
15-20 . . .	585	673	40	44	401	318	907	878	14	9	53	78
20-40 . . .	237	276	12	19	699	638	783	741	64	86	205	240
40-60 . . .	102	117	6	17	644	617	368	357	254	266	626	626
60 and over . . .	48	94	5	14	501	463	109	121	451	443	886	865
Christian . . .	659	679	560	597	321	297	373	340	20	24	67	63
0-5 . . .	987	995	993	991	11	3	6	7	2	2	1	2
5-10 . . .	975	988	968	982	25	7	31	18	..	5	1	..
10-15 . . .	962	981	933	954	38	14	65	43	..	5	2	3
15-20 . . .	848	953	571	647	145	44	420	338	7	3	9	15
20-40 . . .	546	564	158	275	438	416	784	677	16	20	58	48
40-60 . . .	96	101	105	196	825	805	589	448	79	94	306	356
60 and over . . .	114	136	146	119	729	568	110	102	157	296	744	779
Others . . .	443	461	368	434	487	479	499	451	70	60	133	115
0-5 . . .	984	989	972	993	16	11	28	7
5-10 . . .	933	967	837	938	67	33	160	62	3	..
10-15 . . .	857	878	655	787	133	122	326	204	10	..	19	9
15-20 . . .	539	806	215	469	426	185	749	510	35	9	36	21
20-40 . . .	193	319	68	189	737	618	841	736	70	63	91	75
40-60 . . .	45	56	34	47	790	845	476	635	165	99	490	318
60 and over . . .	49	93	10	19	590	640	212	269	361	267	778	712

SUBSIDIARY TABLE II.
Distribution by civil condition of 1,000 of each sex, at certain ages in each religion and Natural Division.

MALES.

Religion and Natural Division.	ALL AGES.																	
	0-5.			5-10.			10-15.			15-40.			40 AND OVER.					
	Unmarried.	Married.	Widowed.	Unmarried.	Married.	Widowed.	Unmarried.	Married.	Widowed.	Unmarried.	Married.	Widowed.	Unmarried.	Married.	Widowed.			
	2	3	4	5	6	7	8	9	10	11	12	13	14	15	16	17	18	19
CENTRAL INDIA AGENCY.																		
All Religions	444	495	61	981	18	1	895	102	3	780	21	6	193	756	51	40	747	213
Hindu	438	500	62	980	19	1	880	108	3	766	227	7	187	761	52	41	742	217
Muslim	467	471	62	989	10	1	932	66	2	871	125	4	254	694	52	25	775	200
Tribal	511	450	39	902	8	..	950	49	1	874	123	3	197	764	39	14	838	148
Jain	472	438	90	908	32	..	955	44	1	911	88	1	316	631	53	92	617	291
Christian	650	321	20	967	11	2	975	25	..	962	38	..	611	374	14	97	817	86
Others	443	487	70	984	16	..	933	67	..	857	133	10	209	669	62	46	755	199
WEST.																		
All Religions	457	480	63	983	16	1	929	68	3	839	156	5	204	744	52	36	748	216
Hindu	449	486	65	981	18	1	925	72	3	828	167	5	193	754	53	38	740	222
Muslim	475	463	62	989	10	1	941	58	1	893	104	3	269	679	52	26	773	201
Tribal	517	444	39	993	7	..	954	45	1	883	114	3	203	758	39	15	835	150
Jain	465	442	93	960	39	1	958	41	1	919	80	1	318	629	53	88	618	294
Christian	663	317	20	986	12	2	979	21	..	965	35	..	620	366	14	99	814	87
Others	448	488	64	992	8	..	945	55	..	864	128	8	279	668	53	48	766	186
EAST.																		
All Religions	430	511	59	979	20	1	867	139	4	715	277	8	181	768	51	44	746	219
Hindu	420	512	59	979	20	1	854	142	4	710	282	8	181	769	50	45	744	211
Muslim	438	500	62	988	11	1	902	94	4	797	195	8	200	745	55	23	780	197
Tribal	471	490	39	985	14	1	920	77	3	809	184	7	157	805	38	10	854	136
Jain	493	425	62	991	9	..	948	51	1	880	110	1	303	641	51	104	614	282
Christian	578	405	17	1,000	923	77	..	923	77	..	434	552	14	82	852	66
Others	416	482	102	989	61	..	877	123	..	830	153	17	224	669	107	31	688	281

SUBSIDIARY TABLE II—concl.
Distribution by civil condition of 1,000 of each sex at certain ages in each religion and Natural Division—concl.

Religion and Natural Division.	FEMALES.																	
	ALL AGES.			0—5.			5—10.			10—15.			15—40.			40 AND OVER.		
	Unmarried.	Married.	Widowed.	Unmarried.	Married.	Widowed.	Unmarried.	Married.	Widowed.	Unmarried.	Married.	Widowed.	Unmarried.	Married.	Widowed.	Unmarried.	Married.	Widowed.
CENTRAL INDIA AGENCY.																		
All Religions	331	513	156	984	20	7	8	223	6	11	460	13	39	849	112	12	392	596
Hindu	323	518	159	967	31	2	754	240	6	506	481	13	37	847	116	12	388	600
Muslim	363	491	146	981	18	1	863	133	4	659	384	7	40	868	86	12	395	592
Tribal	438	460	102	991	9	..	914	84	2	727	269	4	56	874	70	9	486	505
Jain	305	464	231	986	11	3	872	122	6	635	353	12	18	811	171	6	314	680
Christian	580	373	67	993	6	1	968	31	1	933	65	2	257	697	46	111	520	369
Others	368	499	133	972	28	..	837	160	3	655	326	19	104	819	77	29	422	549
WEST.																		
All Religions	380	501	149	974	25	1	803	193	4	571	420	9	45	854	101	14	388	598
Hindu	338	508	154	970	29	1	778	217	5	539	451	10	42	852	106	15	380	605
Muslim	374	483	143	981	18	1	883	113	4	688	306	6	50	867	83	12	394	594
Tribal	444	454	102	992	7	1	920	78	2	737	259	4	58	874	68	9	475	516
Jain	308	467	225	986	11	3	883	111	6	650	341	9	22	818	160	7	314	679
Christian	560	314	66	993	6	1	966	32	2	931	67	2	251	702	47	109	522	363
Others	364	510	126	971	29	..	853	143	4	634	346	20	99	824	77	36	445	519
EAST.																		
All Religions	311	526	163	966	33	1	736	257	7	480	505	15	33	843	124	9	398	593
Hindu	309	527	164	965	33	2	731	261	8	475	510	15	33	842	125	9	396	595
Muslim	327	516	157	981	18	1	790	205	5	554	434	12	35	869	96	13	401	586
Tribal	402	498	100	979	20	1	873	124	3	658	334	8	43	873	84	6	558	436
Jain	297	456	247	987	12	1	841	152	7	591	390	19	8	787	255	3	312	685
Christian	561	370	69	1,000	1,000	972	28	..	322	636	42	146	488	366
Others	387	445	167	974	26	..	760	250	..	746	236	18	129	790	81	..	318	682

SUBSIDIARY TABLE III.

Distribution by main age periods and civil condition of 10,000 of each Sex and Religion.

Religion and Age.	MALES.			FEMALES.		
	Unmarried.	Married.	Widowed.	Unmarried.	Married.	Widowed.
1	2	3	4	5	6	7
All Religions	4,445	4,945	610	3,314	5,128	1,558
0—10	2,590	160	5	2,522	330	10
10—15	971	267	8	607	528	13
15—40	813	3,176	214	164	5,570	472
40 and over	71	1,342	383	21	700	1,063
Hindu	4,385	4,995	620	3,228	5,180	1,592
0—10	2,567	170	5	2,469	352	10
10—15	956	283	8	580	551	14
15—40	789	3,212	218	158	3,579	490
40 and over	73	1,330	389	21	698	1,078
Muslim	4,667	4,709	624	3,632	4,905	1,463
0—10	2,517	97	3	2,666	200	7
10—15	1,025	147	5	752	382	8
15—40	1,075	2,935	221	191	3,596	358
40 and over	50	1,530	395	23	727	1,090
Tribal	5,110	4,501	389	4,381	4,598	1,021
0—10	3,160	89	1	3,258	140	4
10—15	1,175	165	4	889	328	5
15—40	752	2,922	150	220	3,420	274
40 and over	23	1,325	234	13	710	738
Jain	4,715	4,380	905	3,054	4,637	2,302
0—10	2,176	84	2	2,326	152	11
10—15	936	91	1	637	354	11
15—40	1,392	2,785	233	77	3,408	720
40 and over	211	1,420	669	14	723	1,567
Christian	6,586	3,215	199	5,598	3,735	667
0—10	2,222	40	2	3,095	55	4
10—15	980	38	..	1,280	89	2
15—40	3,247	1,989	77	1,083	2,937	196
40 and over	137	1,148	120	140	654	465
Others	4,426	4,867	707	3,677	4,996	1,327
0—10	2,302	92	..	2,444	225	4
10—15	784	121	9	714	355	22
15—40	1,245	3,092	287	468	3,684	348
40 and over	95	1,562	411	51	732	953

SUBSIDIARY TABLE IV.
Proportion of Sexes by Civil Condition at certain ages for Religions and Natural Divisions.

NUMBER OF FEMALES PER 1,000 MALES.

Natural Division and Religion.	ALL AGES.														
	0—10.			10—15.			15—40.			40 AND OVER.					
	Unmarried.	Married.	Widowed.	Unmarried.	Married.	Widowed.	Unmarried.	Married.	Widowed.	Unmarried.	Married.	Widowed.			
1	2	3	4	5	6	7	8	9	10	11	12	13	14	15	16
CENTRAL INDIA AGENCY.	707	983	2,421	923	1,948	1,943	592	1,875	1,616	190	1,065	2,089	282	495	2,630
Hindu	699	985	2,438	913	1,965	1,925	576	1,851	1,617	190	1,058	2,137	275	498	2,633
Muslim	700	936	2,106	952	1,847	1,829	660	2,333	1,613	160	1,101	1,454	408	427	2,480
Tribal	853	1,016	2,608	1,026	1,577	2,285	753	1,977	1,225	291	1,164	1,821	555	533	3,139
Jain	575	939	2,264	948	1,591	6,210	603	3,459	9,000	49	1,086	2,739	59	451	2,078
Christian	640	874	2,521	1,047	1,041	2,000	983	1,739	..	251	1,111	1,913	768	429	2,903
Others	678	838	1,532	866	2,000	..	743	2,390	2,000	306	972	930	438	383	1,892
WEST.	712	969	2,212	925	2,398	1,709	612	2,423	1,671	201	1,059	1,818	356	455	2,435
Hindu	699	1,031	2,209	908	2,510	1,626	585	2,432	1,662	201	1,045	1,858	353	454	2,410
Muslim	699	925	2,030	957	1,813	2,238	682	2,607	1,902	159	1,104	1,399	369	408	2,374
Tribal	854	1,018	2,615	1,031	1,595	3,058	755	2,054	1,320	292	1,171	1,754	560	525	3,179
Jain	577	918	2,106	951	1,363	6,333	634	3,819	8,000	56	1,077	2,478	69	431	1,961
Christian	628	878	2,469	1,060	1,190	2,000	984	1,950	..	235	1,109	1,886	740	432	2,853
Others	663	855	1,593	854	2,526	..	722	2,656	2,500	292	1,007	1,191	482	377	1,813
EAST.	700	997	2,671	920	1,682	1,959	568	1,050	1,579	178	1,071	2,394	211	543	2,877
Hindu	698	998	2,681	917	1,078	1,989	566	1,535	1,590	178	1,070	2,415	205	544	2,880
Muslim	702	974	2,378	935	1,926	1,214	574	1,843	1,262	162	1,092	1,640	571	497	2,885
Tribal	841	1,003	2,562	987	1,509	1,091	736	1,648	1,000	287	1,122	2,254	513	580	2,863
Jain	566	1,006	2,831	480	2,478	6,000	517	2,756	11,000	25	1,113	3,620	28	525	2,509
Christian	863	812	3,500	892	972	333	..	730	1,138	3,000	1,200	385	3,750
Others	759	751	1,333	933	1,167	..	837	1,444	1,000	393	808	517	..	424	2,222

SUBSIDIARY TABLE V.

Distribution by Civil Condition of 1,000 of each sex at certain Ages for selected Castes.

DISTRIBUTION OF 1,000 MALES OF EACH AGE BY CIVIL CONDITION.

Caste.	ALL AGES.						0-6.			7-13.			14-18.			17-23.			24-43.			44 AND OVER.				
	Un-married.	Married.	Widowed.	Un-married.	Married.	Widowed.	Un-married.	Married.	Widowed.	Un-married.	Married.	Widowed.	Un-married.	Married.	Widowed.	Un-married.	Married.	Widowed.	Un-married.	Married.	Widowed.	Un-married.	Married.	Widowed.		
																									2	3
<i>Hindu.</i>																										
Ahr	417	515	68	978	21	1	816	179	5	504	480	16	279	688	33	72	843	85	25	718						
Beiga (Hindu and Tribal)	501	463	30	986	14	..	913	83	4	684	301	15	382	584	34	41	914	45	12	839						
Bala	399	545	56	983	16	1	867	188	5	464	520	16	163	810	27	24	912	64	11	773						
Bania	436	470	94	986	13	1	865	181	4	649	386	15	382	620	48	194	765	101	68	607						
Banjara	538	403	59	985	12	3	964	33	3	819	163	18	508	466	31	114	815	71	28	780						
Banphor	402	540	58	963	36	1	775	219	6	449	520	31	184	763	48	46	888	71	47	744						
Bhli (Hindu and Tribal)	519	445	36	982	8	..	940	57	7	719	275	6	333	652	15	52	897	51	14	819						
Brahman	480	489	81	984	15	..	851	142	3	608	379	13	422	552	26	201	711	88	106	588						
Chamar	411	540	49	978	21	1	817	178	5	457	525	18	171	801	28	31	909	60	16	782						
Dhobi	417	521	62	978	21	1	828	164	8	507	476	17	232	735	33	54	867	79	27	740						
Gadaria	374	547	79	972	22	6	699	278	28	373	599	28	179	776	45	45	863	892	22	683						
Gujar	406	516	78	974	22	4	814	180	6	512	470	28	283	679	38	94	116	90	40	689						
Gond (Hindu and Tribal)	453	593	44	983	16	1	884	112	4	604	383	13	273	699	28	46	893	61	13	827						
Jat	411	593	86	974	24	2	858	188	4	607	374	19	317	637	46	97	804	99	36	673						
Kachhi	421	518	61	978	21	1	830	165	5	517	467	16	234	730	36	67	857	76	17	744						
Kayastha	509	399	92	983	16	1	964	35	1	843	152	5	572	387	41	197	704	99	76	618						
Koli	395	538	67	974	25	1	798	196	6	476	504	20	225	732	43	57	860	83	36	781						
Kotwar (Hindu and Tribal)	389	548	63	982	18	..	816	176	8	465	512	23	187	780	33	85	884	81	17	780						
Kurmi	397	564	75	983	104	3	582	407	11	362	616	22	198	761	41	80	828	92	33	685						
Lodhi	441	491	69	960	10	..	868	130	2	576	412	12	318	650	32	87	820	98	27	747						
Mali	414	511	75	981	18	1	894	98	3	573	418	9	281	681	38	53	862	85	30	697						
Mohar	471	471	58	979	19	2	884	118	3	629	367	14	389	631	30	71	833	76	24	738						
Moghla (Hindu and Tribal)	483	475	42	987	18	..	902	97	1	640	356	4	276	692	32	45	903	52	23	791						
Nal	416	510	74	980	19	1	847	147	6	561	430	19	274	691	35	71	838	91	29	706						
Rajput	477	444	79	983	16	1	925	72	3	699	283	18	411	553	36	150	759	91	69	651						
Fondha	416	494	90	986	13	1	846	146	8	579	394	27	282	668	32	94	805	101	59	646						
Sor (Hindu and Tribal)	434	504	62	930	68	2	860	131	8	472	514	14	303	644	53	48	838	114	17	816						
Teel	380	554	66	950	49	1	699	298	8	399	571	30	203	755	42	54	886	80	29	731						
<i>Muslim.</i>																										
Jolaha	385	571	94	969	29	3	641	349	10	872	568	60	198	687	115	42	861	97	23	706						
sthan	474	462	64	991	9	..	765	44	1	786	206	8	522	464	24	108	818	74	19	738						
Sheikh	466	466	68	989	10	1	927	70	3	769	220	11	470	501	29	99	816	85	22	733						

SUBSIDIARY TABLE V—concl'd.
Distribution by Civil Condition of 1,000 of each sex at certain Ages for selected Castes—concl'd.

Caste.	DISTRIBUTION OF 1,000 FEMALES OF EACH AGE BY CIVIL CONDITION.																					
	ALL AGES.			0—6.			7—13.			14—16.			17—23.			24—43.			44 AND OVER.			
	Un-married.	Married.	Widowed.	Un-married.	Married.	Widowed.	Un-married.	Married.	Widowed.	Un-married.	Married.	Widowed.	Un-married.	Married.	Widowed.	Un-married.	Married.	Widowed.				
1	2	3	4	5	6	7	8	9	10	11	12	13	14	15	16	17	18	19	20	21	22	
<i>Hindu.</i>																						
Ahr	303	548	140	637	61	2	602	380	0	100	873	27	31	634	35	20	810	170	11	348	640	
Baiga (Hindu and Tribal)	415	483	102	982	17	1	830	102	8	333	649	18	69	896	33	11	873	116	7	445	348	
Palal	294	543	163	966	32	2	543	440	8	55	910	35	15	947	28	8	795	197	7	318	675	
Bania	291	489	220	962	36	2	699	291	10	102	860	88	29	807	74	16	711	273	11	281	708	
Banjara	405	479	166	987	12	1	806	132	2	290	689	12	50	923	27	14	843	143	15	398	592	
Bansphor	317	558	125	948	51	1	599	392	9	150	817	33	32	925	43	17	838	145	45	407	548	
Bhil (Hindu and Tribal)	453	400	87	991	8	1	800	138	2	343	649	8	87	896	17	17	878	105	12	445	543	
Brahman	290	475	235	967	30	3	687	363	10	130	822	48	30	877	93	14	688	298	6	271	723	
Chamar	313	548	139	952	47	1	587	305	8	90	888	22	28	941	31	26	802	172	11	357	632	
Dhobi	306	540	154	964	36	..	603	388	7	121	897	22	39	920	41	19	812	169	11	331	638	
Gadaria	285	568	147	940	55	5	479	506	15	83	842	73	29	914	57	13	815	173	15	366	619	
Gujar	281	568	151	956	43	1	543	451	6	80	901	19	18	947	35	7	824	169	4	358	638	
Gond (Hindu and Tribal)	370	505	125	974	24	2	758	237	5	242	734	24	54	914	32	12	845	143	8	398	596	
Jat	285	524	191	959	30	2	629	362	9	145	825	30	24	927	48	12	770	218	8	323	609	
Kachhl.	313	532	155	963	36	1	641	351	8	94	884	22	33	932	35	18	796	186	9	326	665	
Kayastha	333	444	223	976	23	1	853	140	7	332	650	28	54	859	87	12	736	252	4	294	702	
Koli	293	545	160	959	39	2	605	384	11	134	833	33	35	919	46	15	809	184	11	364	625	
Kotwar (Hindu and Tribal)	294	545	161	970	29	1	626	364	10	137	844	193	59	898	43	14	802	184	6	368	626	
Kurmi	236	609	155	849	147	4	395	587	18	58	913	29	17	947	36	9	818	173	13	368	619	
Lodhi	314	520	166	968	31	1	638	355	7	151	818	31	57	894	49	31	754	215	36	355	609	
Mali	307	517	176	975	25	..	641	353	6	109	850	41	65	893	42	32	772	196	12	293	695	
Mehar	353	503	144	970	29	1	773	223	4	182	799	19	42	923	35	12	820	168	9	316	675	
Moghla (Hindu and Tribal)	352	513	135	963	36	1	687	311	2	83	878	39	26	933	21	4	812	184	13	370	617	
Nal	298	536	166	958	40	2	627	365	8	97	873	30	28	933	39	18	797	185	16	320	664	
Rajput.	327	469	204	958	40	2	751	342	7	252	719	29	56	867	77	28	714	258	19	381	700	
Soudha	277	554	169	968	31	1	562	432	6	75	902	23	10	952	38	5	793	202	7	580	613	
Sor (Hindu and Tribal)	322	567	111	917	76	25	682	314	4	205	782	13	49	912	39	9	843	148	6	534	469	
Tel	276	572	152	917	80	3	519	469	12	71	904	25	26	940	34	17	817	166	8	330	682	
<i>Muslim.</i>																						
Jolana	289	573	138	947	53	..	457	505	38	247	707	40	86	786	123	37	810	153	2	507	491	
Fathan	375	478	147	986	18	1	830	148	2	297	688	15	78	892	30	22	832	146	10	332	655	
Shekh	302	485	153	982	17	1	824	172	4	265	714	21	59	907	34	17	823	60	14	333	653	

APPENDIX.

A note on the custom known as *Ghar-jamai*.

In paragraph 286 of the India Report for 1911, Sir Edward Gait has discussed the prevalence of a custom known as *Ghar-jamai*. It is one of considerable anthropological interest and an enquiry was made as to its prevalence in Central India. The results show that it is fairly wide-spread amongst different castes and they are summarised below. The information has been collected in different parts of Malwa and the notes show that the accounts regarding the exact share the son-in-law is allowed to inherit in case a son is subsequently born to his father-in-law, vary in certain places.

- | | |
|---|---|
| 1. Bargunda (Wandering caste) | . The practice is prevalent in the absence of a male issue to the father-in-law but he is not entitled to any share in the property except to that which has been given in <i>Kanyadan</i> . |
| 2. Kulmi or Kurmi (Cultivator) | . The custom is general in the absence of any issue to the father-in-law. He is allowed to inherit the property but if a son is born to the father-in-law, the <i>Ghar-jamai</i> is entitled to only half the share in the property. (The practice appears to be different in the Hindustani Kurmis, among whom the son-in-law can only inherit if an instrument is executed before the <i>Panches</i> .) |
| 3. Bhil (Forest tribe) | } The practice is prevalent. The son-in-law is allowed to inherit the property. In the event of a son being born the <i>Ghar-jamai</i> gets as much property as is allowed to him. |
| 4. Korku (Forest tribe) | |
| 5. Gujar (Cultivator) | |
| 6. Kir (Cultivator) | |
| 7. Bhopa (Wandering caste) | . The son-in-law gets no share in the property if a son is born. |
| 8. Chamar (Tanner and labourer) | } The <i>Ghar-jamai</i> is allowed to inherit the property after his father-in-law's death but in case a son is born to his father-in-law he has to forego his claim to half the property. (Another statement is he has no right to it.) |
| 9. Balai (village servant and labourer) | |
| 10. Moghia (Wandering fowler and hunter). | The <i>Ghar-jamai</i> gets half the share in the property if a son is born to his father-in-law. |
| 11. Kirar (Cultivator) | . The practice is prevalent and the <i>Ghar-jamai</i> can only inherit in the absence of other near relatives. He gets the whole property. |
| 12. Pardhi (Hunter and fowler) | . The <i>Ghar-jamai</i> can inherit the whole property of his father-in-law in the absence of any sons; otherwise he gets $\frac{1}{4}$ th of it. |
| 13. Kuchbandhia (Gypsy, a wandering caste). | In the absence of a son, the <i>Ghar-jamai</i> is kept who gets the whole property if a document is executed effecting a transfer. If there is no such document, he only gets a share. |
| 14. Bedia (Vagabond gypsy) | . If a son is born, the <i>Ghar-jamai</i> does not succeed but is given a share only. |
| 15. Nat (Acrobat) | . The custom is prevalent and in the absence of a son the <i>Ghar-jamai</i> inherits the whole property. |
| 16. Sansia (Vagrant criminal tribe) | . The prevalence of the practice is reported. |

The practice is sometimes prevalent in the higher castes, but does not easily come to light. The exigency of matrimonial market is perhaps responsible for the following advertisement in an Indian paper :—

She (the girl) has just entered 9th year of age and is getting proper education and household training. The bridegroom must be of 10 to 14 years of age with adequate education and good family connections. The girl's grandfather wants to celebrate the marriage next year. After the marriage the boy will be required to live with the bride's family where he will be treated and brought up as son and heir.

CHAPTER VII.

Infirmities.

113. **The basis of the figures.**—The Enumeration Book Cover contained the following instructions :—

Column 18 (Infirmities).—If any person be insane, or blind of both eyes, or suffering from corrosive leprosy, or deaf and dumb enter the name of the infirmity in this column; otherwise put a X. Do not enter those who are blind of one eye only or who are suffering from white leprosy only.

No further instructions were issued and in the Abstraction Office the procedure laid down in the Imperial Census Code, Part II, was followed.

114. **Introductory.**—The number of infirmities recorded were the same as in the last Census. They are insanity, deaf-mutism, blindness and leprosy. That the statistics relating to infirmities are, of all the Census statistics, perhaps the least trustworthy has now become a commonplace in the Indian Census literature. None but a qualified medical man can properly diagnose them. Their inclusion in a population Census is not justified as the Census enumerator of the type available in the rural parts is least fitted to secure correct returns. He is generally unable to find out for himself the existence of any of the infirmities and neither can he exercise any control over the inaccuracies in the returns due to wilful concealment or omissions. The infirmity column is placed last in the Schedule. More often than not, his unsavoury questions about bodily infirmities will fail to elicit the right response. On the other hand the collection of statistics under this head is justified on the ground that the decennial Census provides the only opportunity to collect statistics relating to infirmities. However imperfect and vitiated the figures may be, they provide some information as to the incidence of various infirmities by locality, age and sex. The errors are constant from Census to Census and some useful comparisons are possible. In Central India at present they are, however, of little local use. Medical help or relief has yet to make much headway in many States. No useful information has been made available by the States and the previous Agency Reports contain scant material on the subject of infirmities. The discussion will be confined to an analysis of the main figures.

The following points show the sources of error under each of the four infirmities :—

- (i) In some countries an attempt has been made at the Census to distinguish violent forms of mental derangement or insanity proper and idiocy. In India the Census figures include both. This proportion can only be guessed. In the age-period 5-10, 14 persons in 100,000 are returned as insane whereas the proportion rises to 32 in the age-period 25-30. This may point to the fact that very much less than half the number who are returned as insane were congenital idiots.
- (ii) True deaf-mutism is a congenital defect and persons suffering from it are relatively short-lived. The proportions of such persons to the total number living at each age-period should therefore show a steady decline, and if there is a rise at the higher ages this can only be due to the erroneous inclusion of persons who have lost their hearing late in life.
- (iii) The instructions were strictly to the effect that none but those who are totally blind should be recorded. It is possible that those who are partially blind or who are suffering from defective eye-sight due to cataract in the old age may have been included.
- (iv) It is very difficult for the enumerator to diagnose leprosy from leucoderma, yaws and syphilis. He rarely examines the persons and even if he did, he cannot diagnose the cases correctly

The record of these infirmities is further vitiated by the danger of wilful concealment. Nobody is willing, unless its outward manifestation cannot possibly be hidden, to disclose leprosy which is considered to be a loathsome disease. Amongst the higher classes the prevalence of insanity and deaf-mutism is not admitted and in all classes maladies affecting the children never properly come to light. Concealment is least among the blind. The blind always attract pity. The poorer classes trade upon it. Concealment amongst females is marked and general except in blindness. The number of females to males in the other three infirmities is less in every locality. This suggests more concealment amongst the females. It is possible as it is recognised in leprosy, that a particular malady may attack the males more than the females but the disproportion points towards the tendency to conceal.

115. Reference to statistics.—The statistics relating to infirmities are recorded in Table IX—divided into two parts. Part I shows the distribution of the population afflicted according to age and Part II their distribution according to locality. The following Subsidiary Tables are appended to the Chapter:—

- I—Infirm per 100,000 of the total population.
- II—(a) Infirm per 100,000 and
(b) female infirm per 1,000 males. } at certain age-periods.
- III—Age distribution of 10,000 infirm.

In this Census the table of infirmity by selected castes has been abandoned.

116. Variation.—The total number of the afflicted under each of the four infirmities for the present and the last Censuses is shown in the marginal table.

Comparison of Infirmities in 1931 and 1921.

Infirmity.	Number afflicted with ratio per hundred thousand of the population.	
	1931.	1921.
1	2	3
Total	18,025	14,159
Insane	1,549 23	824 14
Deaf-mute	1,896 29	1,749 29
Blind	13,657 207	10,637 178
Lepor	1,084 16	949 16

It will be seen the variation is uneven. Insanity has increased by 88 per cent. and blindness by 28 per cent. Leprosy registers a rise of 14 per cent. while deaf-mutism has increased by 8.4 per cent. As figures prior to 1921 are not available it is not possible to study the variation in the preceding decades. Restricting ourselves to the inter-censal period, it will be seen that the total number of afflicted during the decade has increased by 3,866 or by 27 per cent. The increase in the total population during the decade is 10.5 per cent. The rise in the infirmities is therefore somewhat serious. No very satisfactory explanation can be advanced except it be the vagaries of the figures themselves.

Greater accuracy over the previous enumeration could easily be claimed. There is no serious ground to put forward such a claim nor has there been any change in the method of tabulation. The figures are best left alone to speak for themselves.

117. Comparison with contiguous Provinces.—The marginal table gives comparative figures for each infirmity for the neighbouring Provinces. Insanity prevails to an equal extent in Central India, the United Provinces and Rajputana. Gwalior appears to be less affected while the Central Provinces show higher figures. Central India and Rajputana are much less affected by deaf-mutism than any of the other Provinces. In this Agency Blindness affects the people more than in Gwalior, but

Infirm per 100,000 compared with neighbouring Provinces.

Province.	INSANE.		DEAF-MUTE.		BLIND.		LEPER.	
	Males.	Fe-males.	Males.	Fe-males.	Males.	Fe-males.	Males.	Fe-males.
1	2	3	4	5	6	7	8	9
Central India Agency	28	18	32	25	166	248	22	10
United Provinces	29	16	62	42	260	330	47	11
Gwalior State	16	10	40	45	130	241	15	9
Rajputana Agency	29	16	32	23	234	334	7	3
Central Provinces and Berar.	35	21	92	65	210	313	80	51

vinces. In this Agency Blindness affects the people more than in Gwalior, but

the other contiguous Provinces show a still higher figure. As regards Lepers, Central India occupies an intermediate position.

118. **Multiple infirmities.**—Before each infirmity is noticed separately

Cases of double and triple infirmities.

Infirmities.	Per-sons.	Males.	Fe-males.
1	2	3	4
Total	158	79	79
Insane and Blind	30	16	14
Insane and Leper	1	1	..
Insane and Deaf-mute	56	28	28
Leper and Blind	13	8	5
Leper and Deaf-mute	1	1	..
Blind and Deaf-mute	54	23	31
Insane, Deaf-mute and Blind.	3	2	1

the returns of co-existent infirmities may be considered. It will be seen that the total population afflicted *viz.*, 18,025 is less by 161 than the total of all the 4 infirmities. That is because the marginally noted cases of co-existent infirmities were recorded. 155 persons suffer from double infirmities in the manner detailed in the table and 3 persons are afflicted with the triple misfortune of insanity, deaf-mutism and blindness. Corresponding figures for 1921 are unavailable as the entries relating to dual infirmities were ignored.

Insanity.

CENTRAL INDIA AGENCY
SHOWING
THE DISTRIBUTION OF INSANE
BY STATES

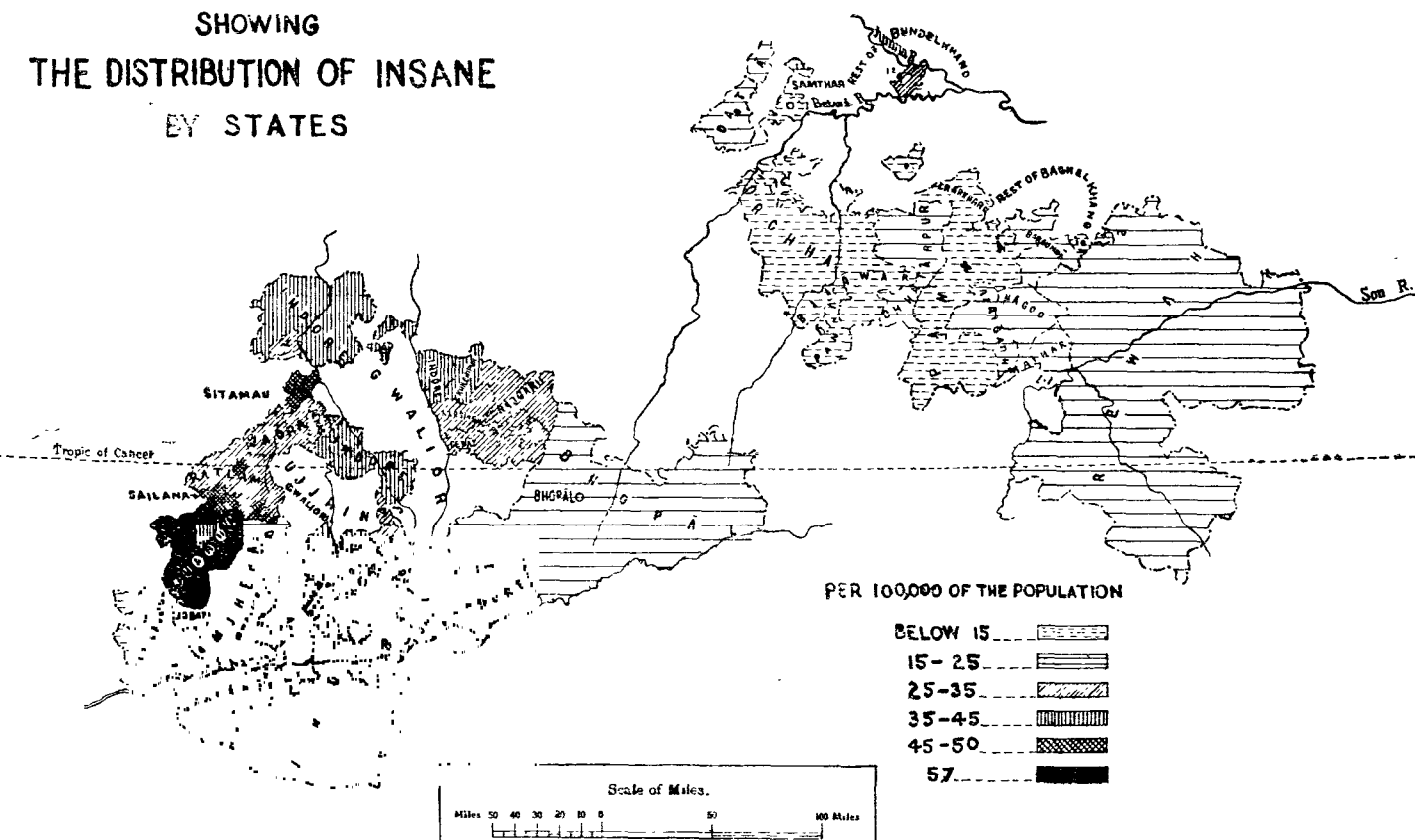

119. **Locality.**—28 per 100,000 males and 18 per 100,000 females were returned as insane in Central India. The proportions vary from State to State and the same is illustrated for both the sexes together in the map. Insanity is more prevalent in the West than in the East. The former has more towns and insanity is supposed to be a concomitant of civilization. Its incidence is high in the central and western Malwa States. In the Bhopal Agency as we move west from eastern Malwa it increases. Thus Bhopal has only 15 and Khilchipur at the farthest west has 35. The whole tract is homogeneous and there is no reason why it

Insanity in the West.

State.	Proportion per 100,000.
1	2
Sailana	48
Sitamau	45
Indore	37
Khilchipur	35
Rajgarh	33
Jaora	31
Narsinggarh	27
Bhopal	15

DIAGRAM SHOWING THE NUMBER PER 100,000 OF EACH SEX IN EACH DECENNIAL AGE - PERIOD

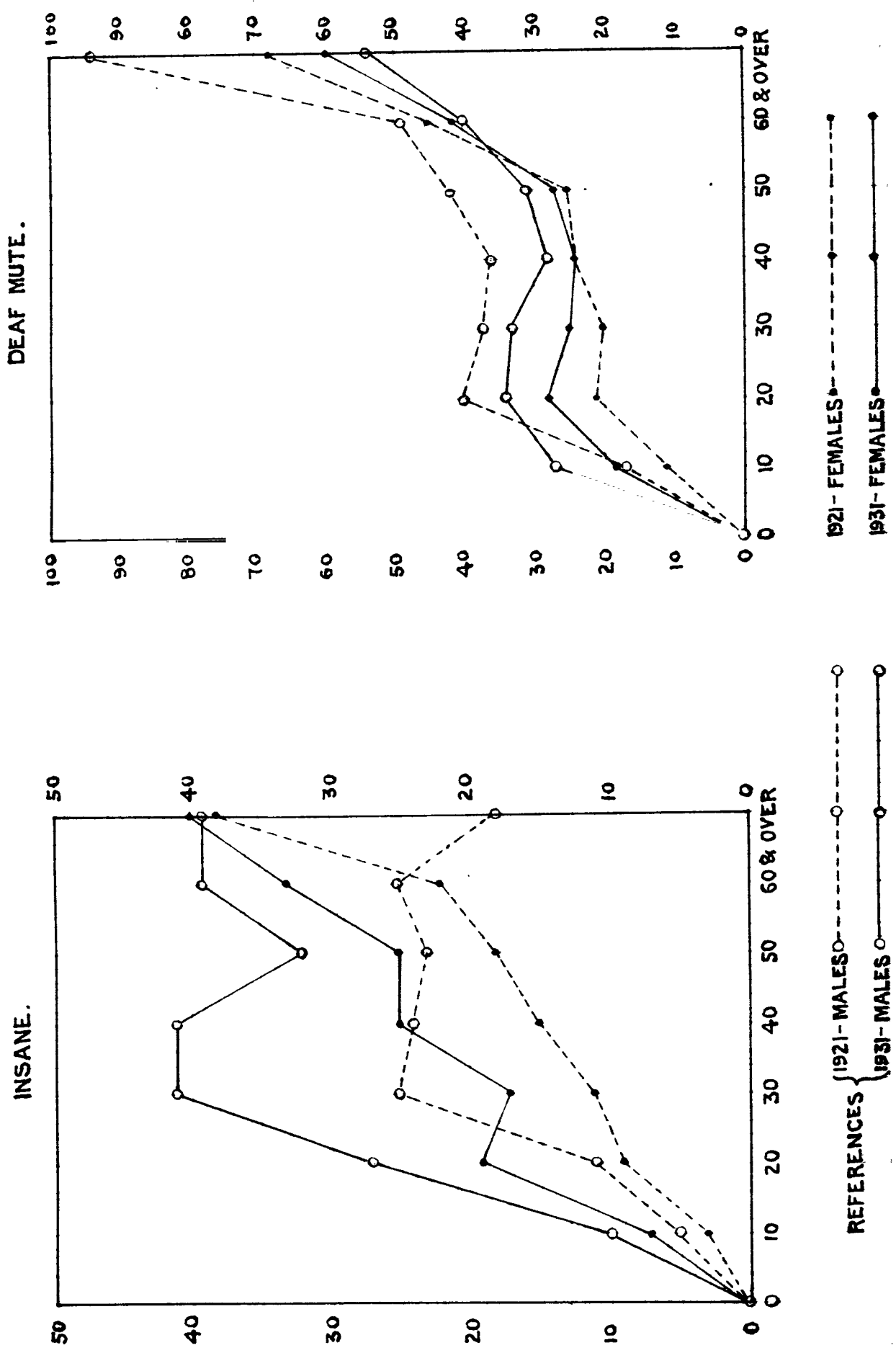

should vary. It is doubtful whether in Central India locality has any influence. It is stated that insanity prevails in the hills or at the foot of the hills. The scattered nature of the territories makes it difficult to verify this. The compact States

Insanity in hill States.

Locality.	Proportion per 100,000.
1	2
Jhabua	57
Barwani	29
Ali-Rajpur	11

in the Vindhya, however, do not support this conclusion. While Jhabua shows the highest incidence for the whole of Central India the similar tract of Ali-Rajpur shows the lowest whereas Barwani has half of Jhabua's proportion. These are Bhil areas and the fluctuations are not easily traceable to any definite causes. The proportions in the principal States of the Eastern Division are given below :—

Datia	22
Chhatarpur	15
Orchha	14
Charkhari	11
Panna	9
Samthar	6
Ajaigarh	19
Nagod.	20
Maihar	16
Rewa	18

120. Age and Sex.—From the statistics it appears that insanity is more prevalent among the males than among the females. The number of females afflicted to 1,000 males is 604. Next to leprosy this is the lowest ratio. In cases of unmarried females there is perhaps concealment. In the upper classes women have a greater standard of comfort, which helps them to tide over crises in life arising out of maternity or ill-health. The proportionate number of insanes by age-periods is given in different forms in Subsidiary Tables II and III. The proportion by decennial age-periods is illustrated graphically. The rise in the curves shows that insanity develops before 30. It is somewhat earlier among the females in the age-period 10-20. There is another rise for them in the period 30-40. These two periods correspond respectively to those of premature motherhood and of the strain of excessive child-bearing and other family worries. Thereafter the curves show a decline. This may mean the insane die and fall out in number, but Subsidiary Table III shows otherwise. The proportion of male and female lunatics is highest over 55.

During the decade insanity has increased by 88 per cent. This is almost three times the rise in blindness and six times that in leprosy. I am inclined to suspect the increase in insanity and the accuracy of the returns lends itself to doubt. Insanity includes other kinds of mental disorder and our returns to be accurate must exclude the congenitally weak-minded. Complete insanity manifests itself in adolescence and if there is a decrease in the number of insane at the age-period 0-10 it ought to point to a greater degree of accuracy. The figures show that 4 per 100,000 were returned as insane in 1921 in the age-period 0-10 while the corresponding number for 1931 in the same age group is 9 per 100,000. Instead of a decrease, the increase is doubled. A considerable error of diagnosis has crept in and the figures for insane include those who are suffering from some form or another of congenital idiocy. The increase in lunacy is therefore much exaggerated and the rise cannot be over 25 per cent.

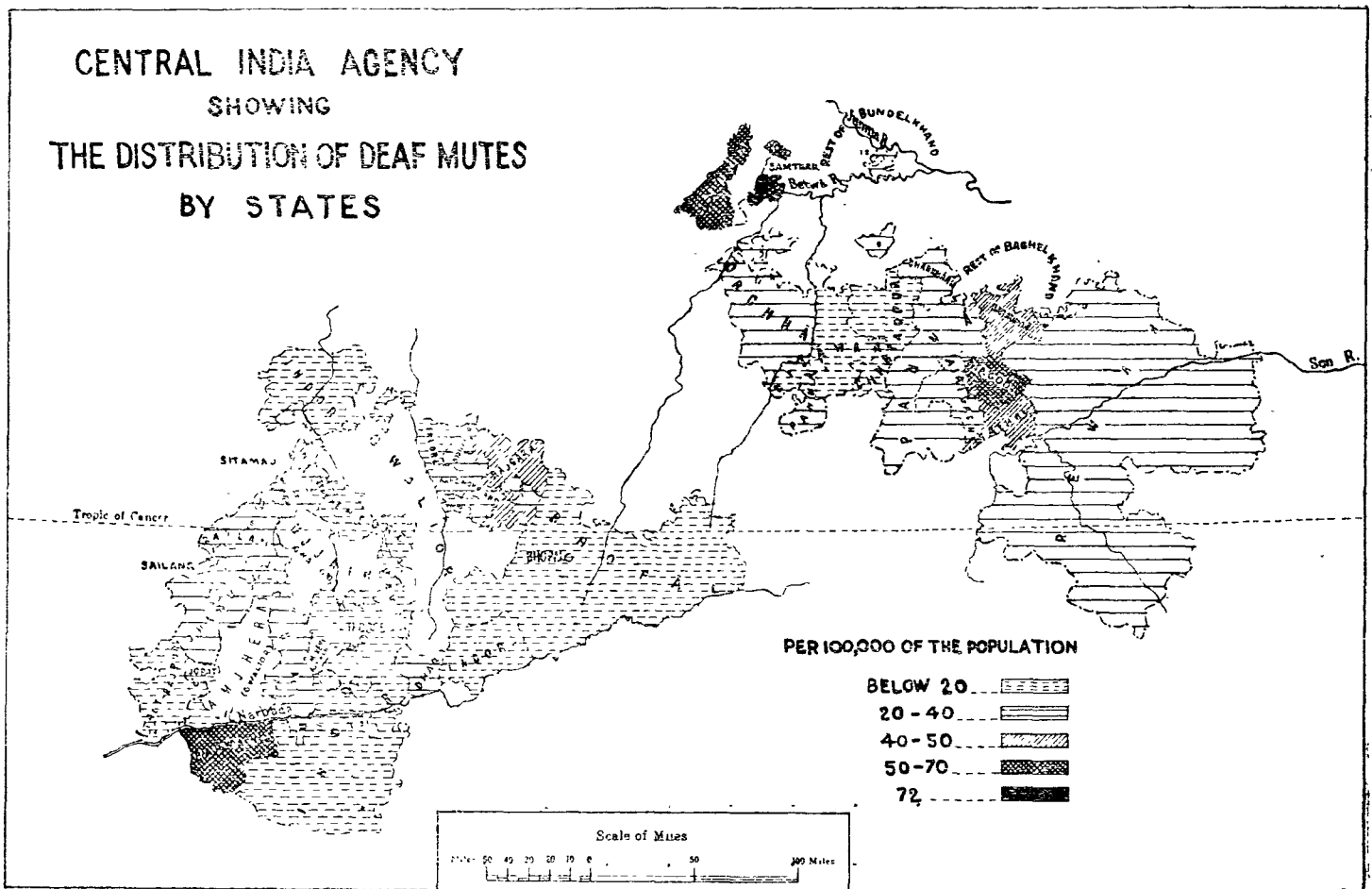
Deaf-mutism.

121. **Main figures.**—According to the Census 32 males per 100,000 and 25 females per 100,000 are deaf-mute, in Central India. The proportional variation and distribution is set out in the map. The proportions in different localities are given in the marginal table. It is stated that deaf-mutism co-exists with cretinism and goitre and it is also believed the pathogenic effect of certain waters has some connection with the spread of this infirmity. There is no information available to prove or disprove these conclusions so far as these parts are concerned. This is a question for investigation by the expert. There appears to be some connection between insanity and deaf-mutism and the returns of double infirmities show that 56 persons were returned as insane and deaf-mute. At the same time it should also be pointed out that

Deaf-mutism by locality.

WEST.		EAST.	
Locality.	Proportion per 100,000.	Locality.	Proportion per 100,000.
1	2	1	2
Sitamau . . .	43	Samthar . . .	72
Barwani . . .	59	Datia . . .	67
Rajgarh . . .	46	Nagod . . .	60
Khilchipur . .	37	Maihar . . .	42
Jhabua . . .	34	Ajaigarh . . .	37
Sailana . . .	32	Charkhari . .	31
Narsingharh . .	28	Orchha . . .	27
Jaora . . .	30	Panna . . .	27
Indore . . .	18	Rewa . . .	35
Bhopal . . .	19	Chhatarpur . .	19

nearly an equal number *viz.*, 54 were returned as blind and deaf-mute. In discussing insanity we also saw that in Eastern Central India the number of insanes was less as compared with that in the West, whereas the proportion of deaf-mutes has perceptibly increased in the East. The order according to deaf-mutism is shown along with the order according to insanity in the following table :—

Comparative orders according to Insanity and Deaf-mutism.

WEST.			EAST.		
Locality.	Order according to deaf-mutism.	Order according to Insanity.	Locality.	Order according to deaf-mutism.	Order according to Insanity.
1	2	3	1	2	3
Sailana	6	2	Datia	2	1
Sitamau	3	3	Chhatarpur	10	6
Indore	10	4	Orchha	8	7
Khilchipur	4	5	Charkhari	7	8
Jaora	7	7	Panna	9	9
Rajgarh	2	6	Samthar	1	10
Narsinghgarh	8	9	Ajaigarh	5	3
Bhopal	9	10	Nagod	3	2
Jhabua	5	1	Maihar	4	5
Barwani	1	8	Rewa	6	4

In some places the orders are hopelessly displaced. Nevertheless the coincidence in other cases merits recognition. Some colour is lent to the idea that insanity and deaf-mutism overlap in these areas and it is perhaps just a chance that the enumerator has thrown them into one category or another.

122. **Age and Sex.**—The distribution of the deaf-mutes by decennial age-periods in 1921 and 1931, is shown in the preceding diagram. The greatest number is concentrated in the age-periods 5-10 and 10-20. Deaf-mutism is generally congenital but children afflicted with it suffer omission as the parents will not disclose its existence. Many are ignorant of its existence as it is usual for the parents to think that it is merely a case of retarded development. Our figures are subject to this omission and also to a wrong inclusion of those who are in senile decay in the later ages. The deaf-mutes are short-lived and there should be a steady decline between 30 and 50. The increase in the figures in the later age-periods after 55 is the result of including persons who are hard of hearing due to old age. The proportion of females to one thousand males is 759. This proportion is higher than that of insanity.

Blindness.

CENTRAL INDIA AGENCY
SHOWING
THE DISTRIBUTION OF BLINDNESS
BY STATES

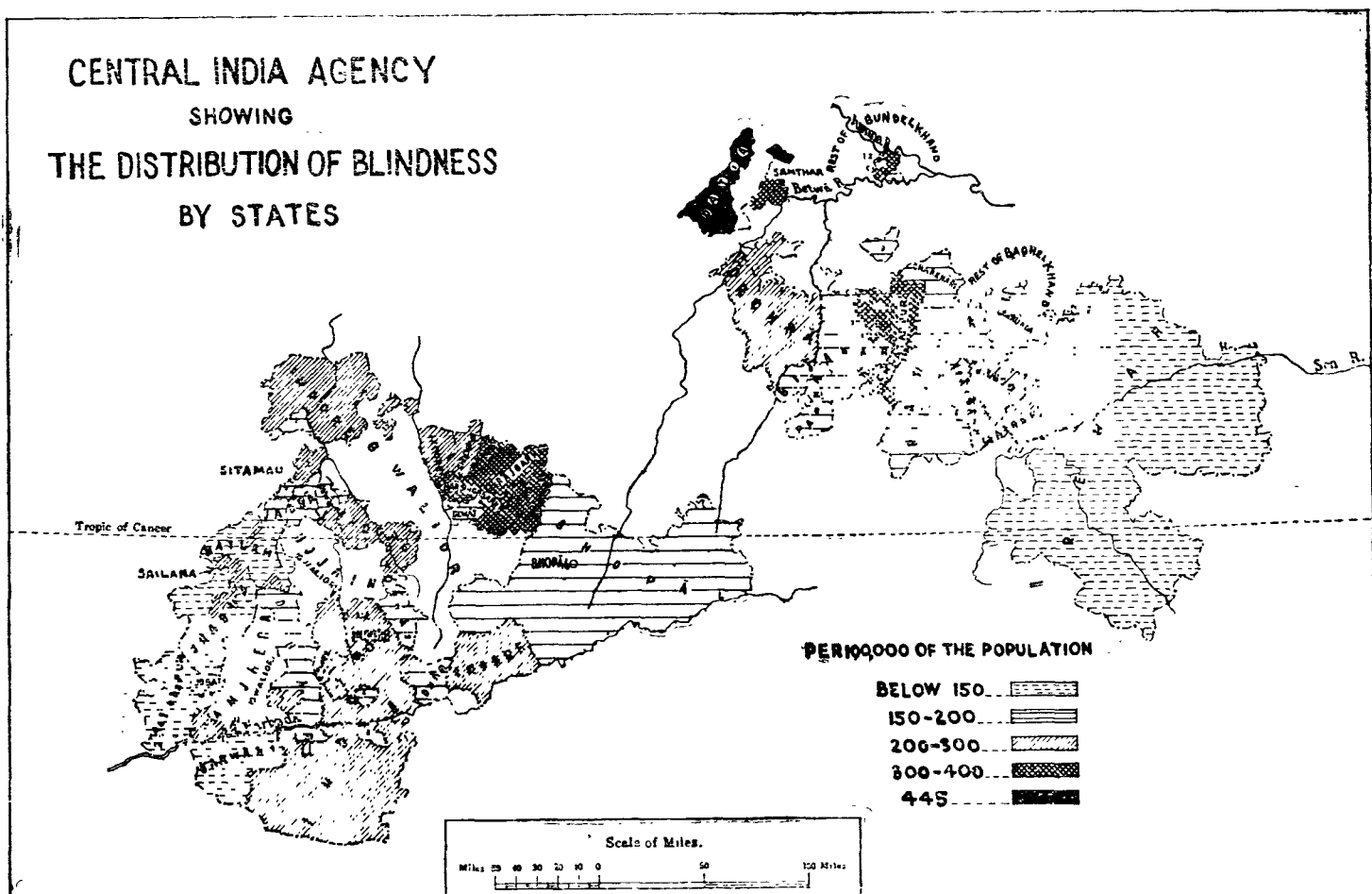

123. **Main figures.**—In Central India 166 males per 100,000 and 248 females per 100,000 are totally blind. The map sets out the variations from State to

State. It is least prevalent in the hilly States of Ali-Rajpur (13), Barwani (132), Jhabua (128) and Rewa (142). It is more marked in those places which lie wholly on the plateau or on the low-lying parts in the East. These include Datia (445), Samthar (384), Rajgarh (326), Narsinghgarh (312) and Baoni (376). Blindness is supposed to be less prevalent in parts where the climate is humid and the country green. It is more common in places which have an arid soil and are exposed to glare. This supports to some extent the distribution in Central India, but it is extremely doubtful if locality has a marked influence. Central India enjoys a mild climate, abundant rainfall and its landscape is always pleasing to the eye. In Western countries the most reliable statistics deal with blindness in the first quarter of life. There it is found that congenital anomalies cause 25 per cent. of blindness. Ophthalmia neonatorum causes approximately another 25 per cent. Syphilis accounts for 10 per cent. of blindness. Atrophy of the optic nerve and injuries respectively cause under 10 per cent. It seems the causes for blindness are also to be sought for in the diseases of the body besides the external influences like locality or physical environment.

Blindness by locality.

WEST.		EAST.	
Locality.	Proportion per 100,000.	Locality.	Proportion per 100,000.
1	2	1	2
Rajgarh	326	Datia	445
Narsinghgarh	312	Samthar	384
Indore	268	Chhatarpur	353
Khilchipur	263	Ajaigarh	295
Sailana	228	Orchha	255
Sitamau	214	Maihar	248
Bhopal	197	Nagod	203
Jaora	197	Charkhari	187
Barwani	132	Panna	152
Jhabua	128	Rewa	142

extent the distribution in Central India, but it is extremely doubtful if locality has a marked influence. Central India enjoys a mild climate, abundant rainfall and its landscape is always pleasing to the eye. In Western countries the most reliable statistics deal with blindness in the first quarter of life. There it is found that congenital anomalies cause 25 per cent. of blindness. Ophthalmia neonatorum causes approximately another 25 per cent. Syphilis accounts for 10 per cent. of blindness. Atrophy of the optic nerve and injuries respectively cause under 10 per cent. It seems the causes for blindness are also to be sought for in the diseases of the body besides the external influences like locality or physical environment.

124. Age and Sex.—The returns for blind include those who are born with the infirmity and those who acquire it in life. The age distribution of blind persons by decennial age-periods is illustrated graphically. Blindness increases with age. Proportionately the number of afflicted in age-period 10-15 is twice that in the age-period below 5. Its prevalence amongst males is not marked between the ages of 20 and 40. It is more marked amongst females in these ages. Both amongst males and females, in ages 55-60 there are twice as many as those in 45-50. Over 60, 13 per mille among males and 22 per mille among females are blind.

The number of females afflicted per 1,000 males is 1,420 and this is the only infirmity where concealment among females is least. The sex ratio increases over the age of 30 with great rapidity as the table shows. Females are afflicted more than the men because they spend most of the time in ill-ventilated places and in low-roofed cooking places where the smoke is injurious to the eye. There are other causes also. Women have little vitality left after they are over 30. In India they age soon due to the burden of early motherhood. Then there is so much ignorance. In backward areas like Central

Ratio of female blindness by age.

Age-period	Ratio of females to 1,000 males.
1	2
30—35.	1,379
35—40.	1,668
40—45.	1,780
45—50.	1,663
50—55.	1,558
55—60.	1,890
60 and over	1,806

India where medical facilities are yet wanting, crude eye operations are performed which in large number of cases result in permanent injury. Ignorance, dirt, lowered vitality and want of medical aid—these are in turn responsible for the high incidence of blindness among women.

During the decade the number of blind have increased by 3,020. This increase should be attributed in part to a greater accuracy in enumeration. The marginal table shows that the greater portion of increase has taken place in the age-periods above 45 years. The increase in the later age-groups is double that in the earlier ones. Here at least the enumerator has followed the instructions strictly by excluding dim-sighted or partially blind persons.

Variation in blindness at certain age-periods.

Year.	UNDER 45 YEARS.		45 YEARS AND ABOVE.	
	Males.	Females.	Males.	Females.
1	2	3	4	5
1931	2,866	3,123	2,777	4,891
1921	2,500	2,398	2,180	3,559
Variation	366	725	597	1,332

ly by excluding dim-sighted or partially blind persons.

DIAGRAM SHOWING THE NUMBER PER 100,000 OF EACH SEX IN EACH DECENNIAL AGE-PERIOD

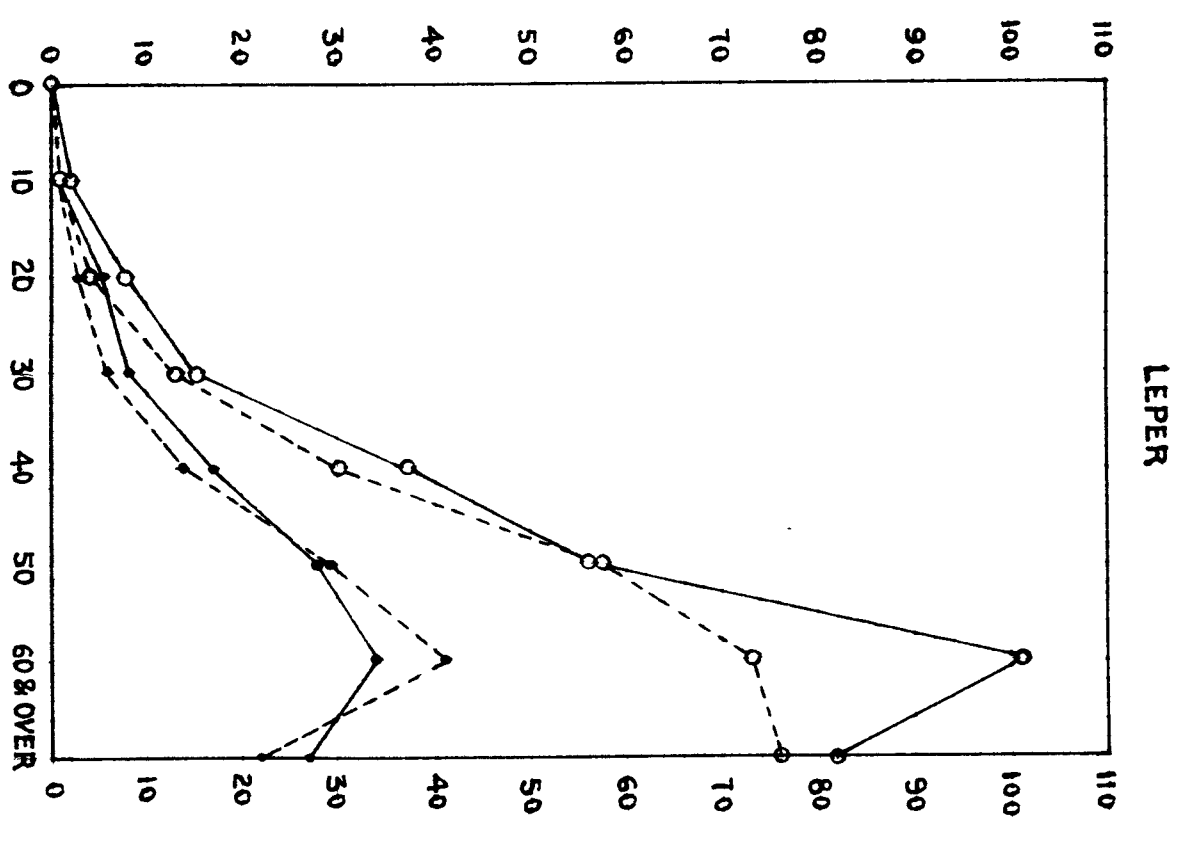
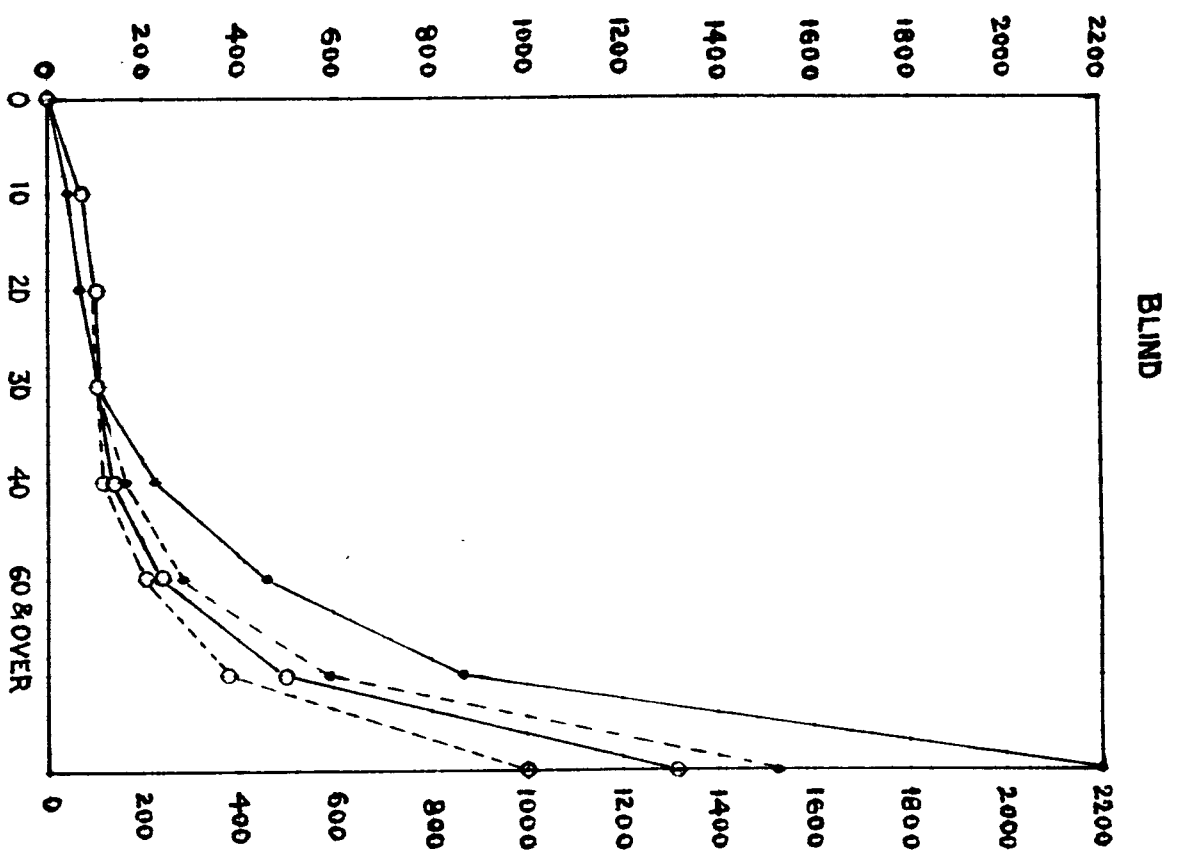

REFERENCES: - 1921 - MALES - - - - - 1931 - MALES - - - - - 1931 - MALES

1921 - FEMALES - - - - - 1931 - FEMALES - - - - - 1931 - FEMALES

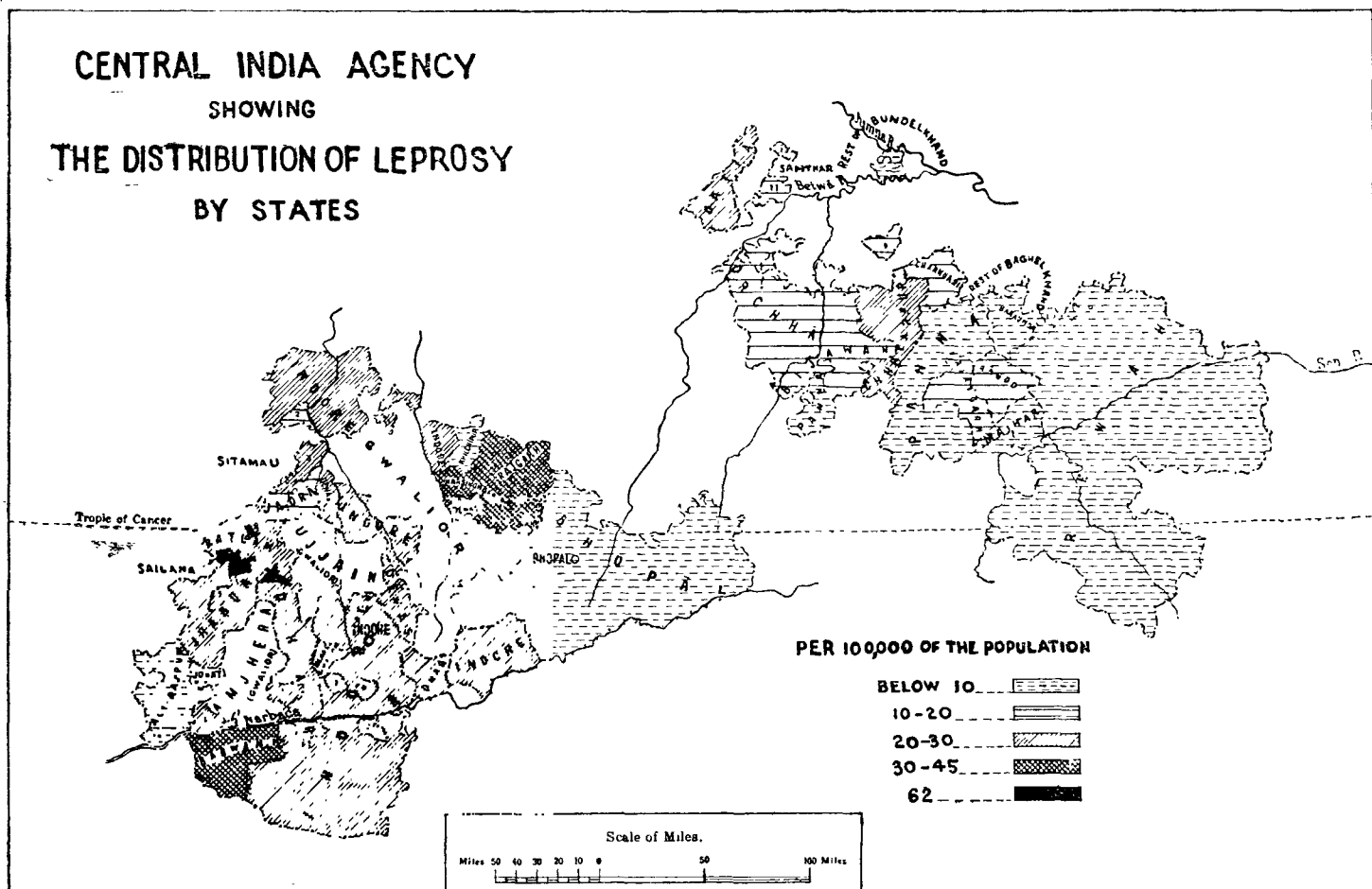
Leprosy.

125. **Main figures.**—22 males per 100,000 and 10 females in 100,000 are returned as lepers in Central India. The map illustrates the distribution by States.

Number of leper (both sexes combined) per 100,000 in the principal States, 1931 and 1921.

WEST.			EAST.		
Locality.	1931.	1921.	Locality.	1931.	1921.
1	2	3	1	2	3
Sailana	62	66	Datia	28	27
Narsinghgarh	44	29	Chhatarpur	28	31
Rajgarh	37	19	Bijawar	18	10
Barwani	31	17	Charkhari	13	12
Dhar	29	53	Ajaigarh	12	21
Sitamau	28	30	Samthar	12	3
Indore	23	20	Orchha	10	13
Jhabua	23	16	Rewa	8	5
Ratlam	22	14	Maihar	6	2
Dewas	20	22	Panna	5	4
Jaora	19	19			
Bhopal	9	14			
Khilchipur	9	26			
Ali-Rajpur	6	6			

The proportion varies considerably. In Sailana there are 62 per 100,000 while in seven States—Bhopal, Khilchipur, Rewa, Ali-Rajpur, Maihar, Panna and Baoni—the proportion is less than 10 per hundred mille. The marginal table sets out the leprosy distribution in Central India. In Malwa, Sailana continues to be the region of maximum concentration of lepers both for the Natural Division as well as for the Agency. In Narsinghgarh, Rajgarh and Barwani there is an appreciable increase. Dhar and Khilchipur show considerable decrease. The marked omission of female returns affects the figures of these localities. In other cases the figures show regional continuity. In the East as we move east from Datia, leprosy appears to grow less in intensity and here too the regional continuity of figures persists. Datia and Chhatarpur continue to be the centres of maximum concentration while Panna and Rewa have the lowest proportion both in 1931 and 1921.

126. **Age and Sex.**—The age distribution of the lepers shows that it increases steadily after the age of 30 and up to the sixtieth year. Below 5 no returns are recorded and in the age-period 10-20, the proportion is 7 per 100,000. Unlike the other three infirmities leprosy is not congenital and its prevalence is to be looked for in the later age-periods. The leper is short lived and the curves fall after the age of sixty. Concealment among females is highest in leprosy. There are only 426 females to 1,000 males.

SUBSIDIARY TABLE I.

Infirm per 100,000 of the total population.

Natural Division.	INSANE.				DEAF-MUTE.				BLIND.				LEPER.			
	Males.		Females.		Males.		Females.		Males.		Females.		Males.		Females.	
	1931.	1921.	1931.	1921.	1931.	1921.	1931.	1921.	1931.	1921.	1931.	1921.	1931.	1921.	1931.	1921.
1	2	3	4	5	6	7	8	9	10	11	12	13	14	15	16	17
CENTRAL INDIA AGENCY	28	16	18	11	32	36	25	23	166	152	248	203	22	21	10	10
West	36	22	23	16	26	40	20	26	116	176	259	224	29	28	13	14
1. British Pargana of Manpur	28	..	61	47	56	41	61	47	84	82	153	61	..
2. Indore	43	25	31	18	18	29	18	15	207	184	328	279	32	29	14	11
<i>Bhopal Agency.</i>																
3. Bhopal	18	16	12	14	24	52	13	41	154	252	240	269	10	15	8	13
4. Khilchipur	50	33	19	11	58	99	14	42	237	255	288	260	8	52	9	..
5. Narsingharh	29	25	24	19	34	36	22	31	228	142	396	206	67	36	20	21
6. Rajgarh	45	17	20	15	55	96	36	40	266	179	386	164	63	25	11	13
<i>Malua Agency.</i>																
7. Dewas States	46	8	15	11	15	39	12	23	152	148	238	172	22	26	17	17
8. Jaora	39	41	23	17	38	25	21	10	176	141	218	165	27	30	10	7
9. Ratlam	40	32	27	17	31	57	25	39	116	84	157	142	27	5	17	22
10. Sailana	67	29	29	23	22	165	41	60	206	244	249	280	89	93	35	38
11. Sitamau	82	44	7	8	54	44	29	39	238	161	190	265	34	44	22	16
<i>Southern Central India States Agency.</i>																
12. Ali-Rajpur	11	4	10	5	23	17	14	7	8	7	18	9	11	4	..	7
13. Barwani	31	3	26	12	63	23	55	17	104	66	159	89	49	28	13	5
14. Dhar	28	35	14	16	24	30	23	28	128	176	178	240	41	70	17	35
15. Jhabua	65	26	48	18	39	43	28	34	115	51	140	96	32	17	13	15
16. Jobat	10	22	..	77	10	..	40	33
East	20	9	13	7	38	31	31	19	159	127	237	182	15	14	7	7
<i>Bundelkhand Agency.</i>																
17. Ajaigarh	18	9	19	14	43	46	31	22	258	184	331	205	14	23	10	19
18. Baoni	40	10	11	..	20	10	43	21	232	127	531	368	..	69	..	11
19. Bijawar	22	5	5	6	15	29	23	7	157	93	184	185	28	10	7	9
20. Charkhari	14	2	7	2	42	9	19	18	174	176	199	210	16	17	9	7
21. Chhatarpur	17	9	12	11	21	45	17	19	280	197	425	303	41	42	14	20
22. Datia	22	12	21	7	71	49	62	27	309	257	581	478	41	39	15	15
23. Orchha	15	9	13	9	32	19	21	13	199	203	311	292	15	15	5	11
24. Panna	12	4	6	6	30	9	23	7	118	97	186	129	6	3	4	5
25. Samthar.	12	17	81	74	62	13	243	176	525	396	23	6
<i>Baghelkhand Agency.</i>																
26. Baraundha	71	36	..	26	..	272	..	367	..	12	..	26	..
27. Kothi	37	20	..	20	93	50	9	10	93	120	188	119	..	10
28. Maihar	18	6	14	6	47	24	37	18	232	132	264	124	12	3
29. Nagod	24	6	16	9	51	53	69	41	173	122	232	215	16	18	3	12
30. Rewa	22	11	14	7	38	30	32	20	116	79	167	95	9	7	7	3
31. Sohawal	..	11	24	37	38	16	86	69	99	93
Rest of Central India Agency.	22	13	7	5	29	37	13	28	138	198	265	290	17	24	2	15

NOTE.—Figures for Khaniadhana have been included in the East.

SUBSIDIARY TABLE II.

(a) Infirm per 100,000 and
(b) Female infirm per 1,000 males } at certain age-periods.

Age.	TOTAL AFFLICTED.		INFIRM PER 100,000.						LEPER.		FEMALES INFIRM PER 1,000 MALES.				
			INSANE.		DEAF-MUTE.		BLIND.				Total afflicted.	Insane.	Deaf-mute.	Blind.	Leper.
	Males.	Fe-males.	Males.	Fe-males.	Males.	Fe-males.	Males.	Fe-males.	Males.	Fe-males.					
1	2	3	4	5	6	7	8	9	10	11	12	13	14	15	16
Total	246	299	28	18	32	25	166	248	22	10	1,155	604	759	1,420	428
0-5.	68	51	4	4	16	12	47	35	792	1,211	788	775	..
5-10	129	97	17	11	40	26	70	61	3	1	691	600	596	794	400
10-15	133	103	19	14	29	21	80	66	7	3	680	663	648	722	379
15-20	203	153	38	24	40	31	118	88	11	7	714	593	868	705	647
20-25	181	125	37	15	36	25	101	82	10	5	674	380	661	794	515
25-30	192	180	44	20	28	25	104	126	19	11	883	418	837	1,143	552
30-35	195	200	41	23	25	23	99	148	32	9	947	528	851	1,379	244
35-40	284	379	41	27	31	25	117	303	44	26	1,251	622	776	1,668	568
40-45	279	411	32	23	28	22	176	340	45	29	1,356	712	712	1,780	583
45-50	469	721	33	27	36	35	334	636	70	27	1,342	708	846	1,663	337
50-55	503	701	34	27	34	24	367	635	72	23	1,263	730	649	1,558	291
55-60	973	1,610	47	42	51	41	793	1,498	90	36	1,657	906	800	1,890	403
60 and over	1,488	2,309	39	40	54	60	1,321	2,197	81	27	1,685	1,100	1,200	1,806	366

SUBSIDIARY TABLE III.

Age Distribution of 10,000 Infirm.

Age.	INSANE.				DEAF-MUTE.				BLIND.				LEPER.			
	Males.		Females.		Males.		Females.		Males.		Females.		Males.		Females.	
	1931.	1921.	1931.	1921.	1931.	1921.	1931.	1921.	1931.	1921.	1931.	1921.	1931.	1921.	1931.	1921.
1	2	3	4	5	6	7	8	9	10	11	12	13	14	15	16	17
Total	10,000	10,000	10,000	10,000	10,000	10,000	10,000	10,000	10,000	10,000	10,000	10,000	10,000	10,000	10,000	10,000
0-5.	197	143	394	179	742	303	770	212	409	372	223	217	26	15	..	33
5-10	776	655	772	567	1,651	955	1,296	1,197	558	709	312	386	197	93	185	199
10-15	828	552	909	657	1,132	1,432	966	1,045	599	675	305	379	382	185	339	331
15-20	1,273	961	1,252	687	1,197	946	1,369	667	673	487	335	255	447	185	679	265
20-25	1,253	1,247	789	836	1,095	808	954	788	578	479	323	327	434	387	525	397
25-30	1,387	1,166	961	746	798	808	880	682	558	517	449	421	763	587	988	530
30-35	1,118	1,227	978	1,194	622	1,019	697	1,045	468	637	454	633	1,132	1,206	648	1,093
35-40	932	1,125	961	806	621	587	636	561	656	549	770	542	1,250	1,020	1,667	993
40-45	611	879	686	1,045	482	854	452	803	579	918	726	864	1,105	1,932	1,512	1,821
45-50	497	695	583	507	482	423	538	318	856	536	1,002	530	1,329	958	1,049	993
50-55	383	491	463	955	343	542	293	894	718	976	787	1,121	1,040	1,345	710	1,954
55-60	331	389	497	149	325	230	342	258	964	412	1,283	536	816	603	772	298
60 and over	414	470	755	1,672	510	1,093	807	1,530	2,384	2,733	3,031	3,789	1,079	1,484	926	1,093

CHAPTER VIII.

Occupation.

Section I.—Introductory.

127. **Reference to Statistics.**—The detailed figures relating to the functional distribution of the people are exhibited in Imperial Table X which gives for the Agency as a whole and for each principal unit the distribution of the total population among earners, working dependents and non-working dependents with the total number of earners who have a secondary occupation and secondly the number of persons following each kind of occupation as their principal means of livelihood, as working dependents and as subsidiary to other occupations. The detailed statistics are summarised, proportioned and compared with previous figures in the following subsidiary tables appended to this Chapter :—

I General Distribution of Occupation :—

- (a) Earners (Principal Occupation) and working Dependents.
- (b) Earners (Subsidiary Occupation).

II Distribution by Sub-Classes in Natural Divisions and Districts :—

- (a) Earners (Principal Occupation) and working Dependents.
- (b) Earners (Subsidiary Occupation).

III Occupation of Females by Sub-Classes and selected Orders and Groups.

IV Selected Occupations giving comparative figures for 1921 and 1931.

VI Number of persons employed in—

- (a) Railways,
- (b) Posts and Telegraphs and
- (c) Irrigation.

Subsidiary Tables V, VII and VIII relating to occupations of Selected Castes and organized industry have been omitted. Imperial Tables XI—Occupation by Caste, Tribe or Race and XII—Educated Unemployment have not been compiled for the Agency as a whole.

128. **The basis of the figures.**—The information relating to the occupation followed by the whole population was obtained from the answers elicited from columns 9, 10, 11 and 12 of the General Schedule. The classification of the enumerated as Earner or Dependant was recorded in column 9 and particulars relating to occupation generally in columns 10 (Principal Occupation) and 11 (Subsidiary Occupation) and if any one was engaged in an organized industry it was entered in column 12. The main instructions for filling up these columns as printed on the Cover of the Enumeration Book for the guidance of the Enumerator ran as follows :—

Column 9.—Enter “ Earner ” or “ Dependent ”. A woman who does house work is a dependent, so is a son who works in the field but does not earn separate wages. A cultivator cultivating as a principal occupation is an Earner.

Column 10.—Enter the principal means of livelihood of all persons who actually do work or carry on business, whether personally or by means of servants or who live on house-rent, pension, etc. Enter the exact occupation and avoid vague terms such as “ service ”, “ writing ” or “ labour ”. Write particulars such as Private Servant, Bania’s Cook ; Clerk, Army Department. Replies such as are given to a Magistrate are not enough. For example in the case of labour, say whether in the fields, or in a Coal mine or jute factory, cotton mill or lac factory, or Earthwork, etc. In the case of agriculture, distinguish between persons who do not cultivate personally, who cultivate their own land, who cultivate rented land and who are hired labourers. If a person makes the articles he sells he should be entered as “ maker and seller ” of them. Women and children

who work at any occupation which helps to augment the family income by permanent and regular work for which a return is obtained in cash or kind must be entered in column 9 as earner and their occupation shown in column 10. For dependents make a X only in column 10.

Column 11.—Enter here any occupation which actual workers pursue at any time of the year in addition to their principal occupation. Thus, if a person lives principally by his earnings as a boatman but partly also by fishing, the word “boatman” will be entered in column 10 and “fisherman” in column 11. If an actual worker has no additional occupation a cross (X) will be put. Dependents who help to support the family by subsidiary work without actually earning wages, e.g., a woman who helps in the field as well as doing house work, will be shown in this column. For other dependents a X will be put.

Column 12.—For managers, clerks, operatives and workmen employed in a factory or by any person employing industry fill up the name of the industry i.e., biscuit-making, coal mining. For individual workers not employed by others put a X.

129. Changes in the Occupation Returns.—At the outset it is necessary to understand certain important changes that have been made in the occupation returns which are a marked feature in this Census. In the previous Census the population was divided into “Actual workers” and “Dependents”. ‘Actual workers’ included persons who actually did work or carried on business whether personally or by means of servants, or who lived on their estate, capital, etc. Children who worked at any occupation which helped to augment the family income were also included among Actual workers. Children and women and old or infirm persons who did no work either personally or by means of servants were treated as Dependents. The occupations of the Actual workers were recorded under two heads: Principal and Subsidiary. Under the former the occupation mainly relied on for support and from which the major part of one’s income was derived was shown. Under the latter head any other occupation or the most important of the other occupations followed at any time of the year was recorded. For Dependents the principal occupation of the Actual workers who supported them was shown.

On this occasion the population has been distributed over two broad divisions: Earners and Dependents and the latter have been further distinguished

Distribution of population between workers and Dependents.

Workers and Dependents.	Number per mille of population.
1	2
1921.	
Actual workers	544
Dependents	450
1931.	
Earners	466
Dependents	534
Working Dependents	44
Non-working Dependents	490

as working and non-working dependents. As in 1921, the occupations have been shown under two heads—Principal and Subsidiary; but the definition of Earner does not exactly correspond with that of ‘Actual worker’ in the previous Census. Only those workers who actually earn something to augment the family income by permanent and regular work have been shown as Earners, while persons who by casual and part time assistance in the work of the family contribute to its support without actually earning wages have been treated as dependents. Thus the dependents in this Census must include a number of persons who according to the procedure

of previous Census might have been classed as workers. Again, unlike the Census of 1921 when the occupation of their supporters was shown for all the dependents, on this occasion the actual work done by any dependents has been shown against them as subsidiary occupation while non-working dependents have been shown without any occupation at all.

130. Earners and working dependents.—It is apparent from above that it was necessary to make a clear and as far as possible unambiguous distinction between an earner and a working dependent. A wholtime worker in an occupation was generally an earner. A part-time worker when he obtained wages was also an earner. But a member of a family who works whole time in assisting the earner in the family occupation or a part-time assistant who helps the family in its occupation without receiving any wages becomes a working dependent. The following instructions given in the Imperial Census Code Chapter VII were service

able in understanding the nature of the implications involved in these distinctions :—

(9) Only those women and children will be shown as earners who help to augment the family income by permanent and regular work for which a return is obtained in cash or in kind. A woman who looks after her house and cooks the food is not an earner but a dependent. But a woman who habitually collects and sells firewood or cowdung is thereby adding to the family income, and should be shown as an earner. A woman who regularly assists her husband in his work (*e.g.*, the wife of a potter who fetches the clay from which he makes his pots) is an all time assistant, but not one who merely renders a little occasional help. A boy who sometimes looks after his father's cattle is a dependent, but one who is a regular cowherd and earns pay as such in cash or in kind should be recorded as such in column 10. It may be assumed, as a rough and ready rule that boys and girls over the age of 10 who actually do field labour or tend cattle are adding to the income of their family and should therefore be entered in column 10 and 11 according to whether they earn pay or not. Boys at School or College should be entered as dependents. Dependents who assist in the work of the family and contribute to its support without actually earning wages should be shown as dependents in column 9 and under subsidiary occupation in column 11.

In spite of a plethora of instructions and circulars, there was a considerable misunderstanding over these questions and constantly difficulties were cropping up requiring further elucidation. Only two points deserve notice as they are of some importance. In column 11, the occupation of the working dependents was the form of the assistance given and not the name of the occupation in which the dependent assisted. In the case of agriculture, the conditions in which are somewhat distinct and peculiar, the occupation shown in column 11 was classed under the principal occupation of the earners. Otherwise the figures for agricultural labour would have been unduly and even wrongly augmented. It was also laid down that in all cases in which the members of a family are regular and all time assistants of the head member in whose name the cultivatory rights are held the entries for such assistants should be the same as those for the head member. For instance the *patta* of the fields is in the name of the eldest brother in a joint family but his younger brothers and grown up sons equally do the field work with him. All were treated as earners. It rarely happens that merely the legal holder of the cultivatory rights is able to cultivate the fields all by himself without the full and effective help of the able bodied grown up male members in the family. In the case of the boys and girls, the rough and ready rule was those under 12 years should be invariably shown as dependents unless they work for others and obtain wages.

131. Classification Scheme.—In the classification of the returns of occupation Dr. Jacques Bertillon's scheme, as adopted for the Indian Census has been

Class.	Sub-class.
A.—Production of Raw materials.	I. Exploitation of Animals and Vegetation.
B.—Preparation and supply of material substances.	II. Exploitation of minerals.
	III. Industry.
	IV. Transport.
	V. Trade.
C.—Public Administration and Liberal Arts.	VI. Public Force.
	VII. Public Administration.
	VIII. Professions and Liberal Arts.
D.—Miscellaneous . . .	IX. Persons living on their income.
	X. Domestic Service.
	XI. Insufficiently described occupations.
	XII. Unproductive.

followed. The scheme was elaborately explained in the India Report of the 1911 and need not be recapitulated here. All the occupations returned are arranged in 4 main classes divided into 12 sub-classes as shown in the margin. These latter have been further subdivided into 55 Orders and 195 Groups. The more important principles which have been followed in classifying the detailed occupations under the

various groups are noticed in the following extracts from the note which accompanied the Alphabetical Index of Occupations circulated by the Census Commissioner for India :—

- (a) Where a person both makes and sells he is classed as a "maker". On the same principle when a person extracts some substance, such as saltpetre, sulphur, carbonate of soda, etc., from the ground and also refines it, he is shown in sub-class II—Exploitation of Minerals, and not in sub-class III—Industry.
- (2) Industrial and trading occupations are divided into 2 main categories :—
 - (a) those where the occupation is classified according to the material worked in, and
 - (b) those where it is classified according to the use which it serves.

As a general rule the first category is reserved for the manufacture and sale of articles the use of which is not finally determined, but it also includes specified articles for which there is no appropriate head in the second category. For example, while shoe-makers are included in the second category (Order 12, Group 82), the makers of waterbags, saddlery, leather portmanteau and the like are included in the first category (Order 6, Group 51).

In a few cases occupations have been classed according to the material worked in, even though certain articles made of it are specified, because the material used is more characteristic of the occupation than the articles made. Thus makers of palm-leaf fans have been shown in Group 56 rather than Group 99. Makers of bamboo screens, leaf plates, etc., have also been shown in Group 56.

(3) Persons employed in Railway Carriage factories have been shown in Group 112 instead of under Order 15, because these factories in India are always worked direct by the railways. The manufacture and repair of railway trucks and carriages is an integral part of the operations of the railway authorities. The principle on which the classification is made is analogous to that followed in the case of makers and sellers or diggers and refiners.

(4) On the other hand railway police and railway doctors are classified in Groups 157 and 169, respectively, because the primary duty of persons thus employed is, in the one case the prevention and detection of crime, and in the other the healing of disease.

As a general rule it may be said that wherever a man's personal occupation is one which involves special training, *e.g.*, that of a doctor, engineer, surveyor, etc., he is classed under the head reserved for that occupation. Exceptions have been made, however, in cases where the work in which he is employed involves further specialization. For this reason a marine engineer is classed in Group 102 and a river surveyor in Group 103. Officers of Government whose occupation is covered by some other Group (*e.g.*, doctors, clergymen, professors, postal, forest, settlement and railway officers and other establishments, etc.) will be included in that Group and not under Group 159. Government peons and *chuprasis* other than those in the above-mentioned establishments will be included in this Group and not in Group 111.

132. Arrangement of detailed occupations.—The arrangement of detailed occupations generally follows the system adopted in 1921 with few minor adjustments in the nature of re-arrangement of certain occupations within a Sub-Class or Order, amalgamation or amplification of certain Groups and in few cases transfer of a Group from one Order or Sub-Class to another. Consequently the number of Orders has been reduced from 56 to 55 and that of Groups increased from 191 to 195 since the last Census. Some of the more important changes may be noticed here.

The agricultural occupations under Sub-Order (*a*) cultivation, Order 1, Sub-Class I were, in 1921, shown in 5 Groups as follows:—

1. Income from rent of agricultural land.
2. Ordinary cultivators.
3. Agents, managers of landed Estates, clerks, rent collectors, etc.
4. Farm servants.
5. Field labourers.

In the present arrangement the agriculturists have been distinguished as non-cultivating proprietors, cultivating owners and tenant cultivators, the farm servants and field labourers, being shown together as agricultural labourers, while the agents and managers of private owners have been differentiated from State servants, and rent collectors, clerks, etc., have been allotted a separate Group.

Under Sub-Order (*b*) the old Groups have been split up to show separate figures for the more important special crops, such as the Pan-Vine. Under Forestry [Sub-Order (*c*)] the wood-cutters and charcoal burners have been separated from the collectors of forest produce. Among the stock raisers, sheep, goat and pig breeders who were shown separately in the previous Census have been combined with herdsmen and shepherds in Group 23. A new Group (26) has been added for lac cultivation under the raisers of small animals and insects. In the past Census they were probably included with the lac collectors or manufacturers. Sub-Class II—Exploitation of minerals has been wholly re-arranged: the three Orders of 1921 (Mines; Quarries of hard rocks; and Salt, etc.), have been re-classed as non-metallic and metallic minerals and the Groups have been split up to give separate details for the principal metals and other substances. Among the textile industries (Order 5, Sub-Class III), the cotton spinners have been included with the sizers and weavers, wool carders and spinners with the blanket and carpet weavers which latter are no more shown. Other fibres shown separately in 1921 are now classed with rope, twine and string. Under Hides, skins, etc., no distinction is kept between tanners, curriers, etc., and makers of leather articles, while under Ceramics separate details for smaller industries, such as glass and crystal ware and porcelain crockery, have been eliminated. Manufacturers of dyes, paint and ink and Paper, cardboard and papier maché do not now find a separate Group under Chemical Products properly so called and analogous. Of those engaged in Food Industries the manufacturers of Tobacco, Opium and Ganja have

each been allotted a separate Group, while Bakers and biscuit makers, Fish curers and makers of Butter, Cheese and *Ghi* have been merged in Others. Under the industries of Dress and the Toilet, the embroiderers who in 1921 were classed with tailors, milliners, etc., have been shown with the hat and cap makers, while the several building industries have been grouped together. The managers and employees of places of public entertainment, clubs, etc., who were shown under miscellaneous and undefined industries in 1921 have been transferred to Letters, Arts and the Sciences under Professions and Liberal Arts. Other smaller industries in that Order have been grouped together. Under Transport by Water, the ship-owners and their employees have been grouped with boat-owners, etc., and the employees in harbours, docks, etc., with those employed on the maintenance of harbours, rivers, etc., while the labourers of the two categories have also been combined. Trade in wood, cork, etc., has been split up to show separately those dealing in wood (not fuel), in barks, in bamboos and canes and in thatches and other forest produce. Hawkers of drink and foodstuffs have been separated from the hawkers in general and given a separate Group under Hotels, Cafes, restaurants, etc., whilst the groups under Other Trade in foodstuffs have been redistributed as for food industries. Medical practitioners have been distinguished as registered and un-registered ones, Dentists and Veterinary Surgeons. Likewise Authors and Editors, Artists and Sculptors, Astronomers and Botanists, Astrologers and Fortune-tellers have been distinguished this time. Of the domestic servants, only the motor drivers and cleaners have been separately shown, all other classes being amalgamated under other domestic servants.

133. Form of presentation of statistics.—The form in which the occupation statistics are finally presented in Imperial Table X differs from that of 1921 due to the change in the method of enumeration. In 1921 the total number of persons (workers as well as non-workers) dependent on each occupation for their support was shown together with an indication how far agriculture was followed as a secondary occupation in combination with the different principal means of subsistence. Now we are not in a position to ascertain the extent to which each occupation gives support to the non-working population. Thus we are unable to distribute the entire population according to the means of their livelihood. The distribution of the working population only (Earners and working dependents) according to the occupations followed has therefore been shown in the table which also gives information as to the extent to which each kind of occupation is resorted to as a subsidiary means of livelihood of the people. The arrangement of 1921 enabled us to gauge the extent to which each occupation gave support to the people as the principal means of their livelihood and how far agriculture supplemented other occupations. In the present arrangement we can know how far each occupation engages the working population in various forms, as principal occupation of the chief earners, as the means of employment of the working assistants and as a secondary pursuit of the earners who need to augment their income from the principal source.

134. Difficulties in classification.—To guard against the difficulty in classifying the entries relating to occupation, the States had been requested to send lists of any obscure or local terms that had been used in the schedule together with their exact significance. This was very helpful in the classification of the agricultural occupations which owing to the prevalence of various terms relating to land tenures in the different States would otherwise have presented a good deal of difficulty specially in the classification of the agriculturists. In the States where the rights of ownership usually vest in the Ruler himself and where there is no *Zamindari* system of land revenue settlement, the classes of land holders which can be rightly treated as 'owners' are few. Generally, the *Jagirdars* and *Muafidars* who hold various kinds of land grants in the States have been classed as owners. In Indore State however the class of tenure-holders who are called *Khatedars* and who have an hereditary occupancy right in their holdings have been treated as owners. Certain returns of occupation in dual terms were also noticed, e.g., *ghas-lakri* or *lakri-ghas bechna*. In such cases the returns have been classified according to the term which occurred first. General terms such as 'shop-keeper', 'service' and 'general labour' could not be totally avoided and in fact the use of the last mentioned term had to be permitted to cover the large number of labourers who have no one kind of labour to engage them through the greater part of the year and who are generally employed on all kinds of odd and miscellaneous work, and the figures under Order 52 mostly represent these. Generally speaking, there were no insurmountable difficulties in the way of classification. The abstraction and tabulation work was carried out in a central office at Indore and each State had deputed some officials to it. This enabled co-operation and co-ordination in work and any doubts were settled by reference to the

DIAGRAM SHOWING THE DISTRIBUTION OF THE WORKING POPULATION
1931 BY OCCUPATION

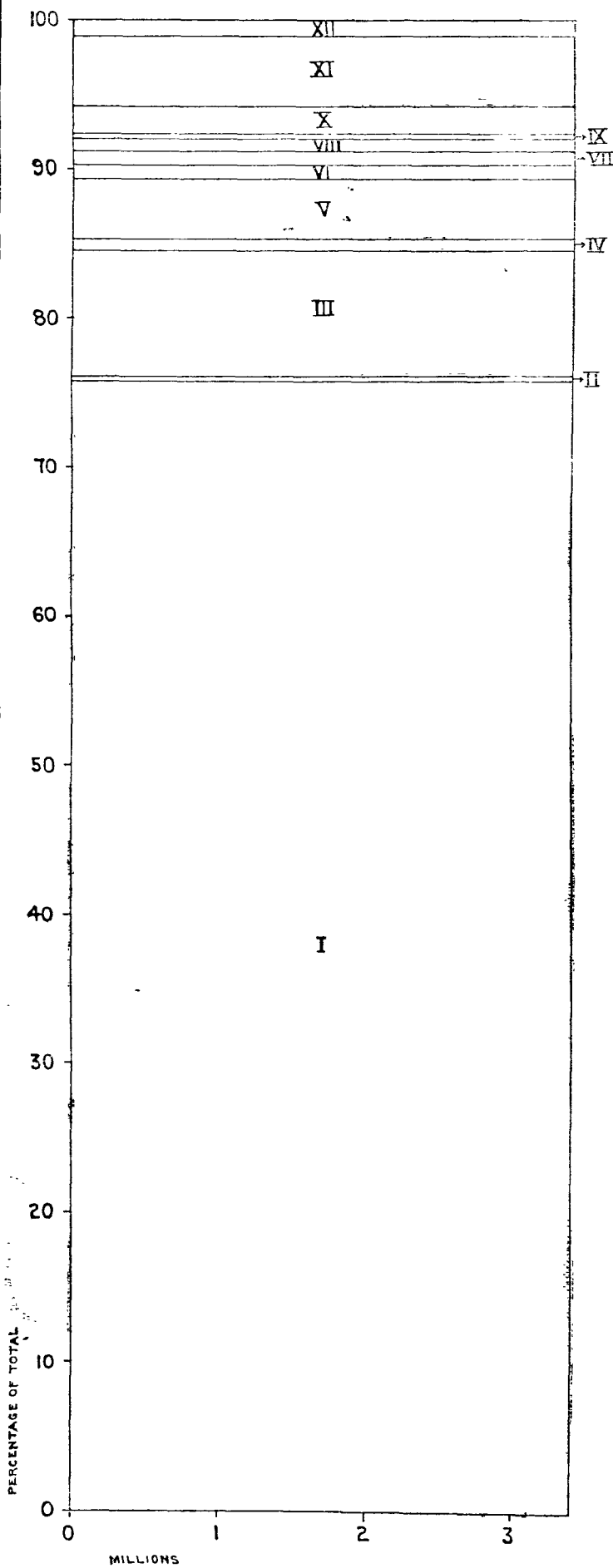

KEY TO SUB-CLASSES.

- I EXPLOITATION OF ANIMALS AND VEGETATION.
- II EXPLOITATION OF MINERALS.
- III INDUSTRY.
- IV TRANSPORT.
- V TRADE.
- VI PUBLIC FORCE.
- VII PUBLIC ADMINISTRATION.
- VIII PROFESSION AND LIBERAL ARTS.
- IX PERSONS LIVING ON THEIR INCOME.
- X DOMESTIC SERVICE.
- XI INSUFFICIENTLY DESCRIBED OCCUPATIONS.
- XII UNPRODUCTIVE.

REFERENCES.

THE WIDTH OF THE COLUMN IS PROPORTIONATE TO THE TOTAL WORKING POPULATION.
THE VERTICAL AREAS ARE THE PERCENTAGES OF EACH OCCUPATION TO THE TOTAL WORKING POPULATION.
THE DIAGRAM IS FOR EARNERS AND WORKING DEPENDANTS COMBINED, AND FOR BOTH SEXES COMBINED.

State officials who were able to explain the significance of any terms used. The Central India Agency has had no local vernacular index of occupations and the general index issued by the Census Commissioner for India has been found to be sufficient for all practical purposes.

135. Accuracy of the Record.—The correct return of occupation has rightly been held to be the most difficult to secure at a general Census. When we bear in mind the agency employed in the collection of the information, the subtleties involved in the distinction between earners and dependents, between principal and subsidiary occupations and between working and non-working dependents and the difficulty felt in cases of multiple occupations, of selecting the two most important ones for entry in the schedule, it is no wonder if inaccuracies have persisted although every attempt is made to minimise the source of errors the most common form of which lies in the use of such general terms as service, labour, agriculture, shop-keeping, etc. It is possible in few cases the traditional caste occupation also may have obscured the real means of subsistence. Some zealous enumerators were of decided opinion that a subsidiary occupation should be entered in all cases for it was thought a pity to let it go blank. This led a local wit in one place to enter the subsidiary occupation of a child of three years as 'playing'. He ought to have gone a step further and entered the principal occupation as 'crying' in column 10 and when not in a fretting mood, its subsidiary occupation as 'playing'. In some cases of combined manufacturer and trader, such as sweetmeat maker and seller, and oil presser and seller, etc., the returns may have been made in the latter class. The vernacular term '*Ghar-ka-kam*' which would ordinarily connote household work was sometimes wrongly used to indicate work in the fields of the family.

Section II.—Statistical results of the Occupation Census.

136. General distribution.—The marginal table gives the general occupational distribution of the population of the Agency. It is also illustrated in the diagram on the opposite page. Of the 6,632,720 persons enumerated 3,384,811 or 51 per cent. are engaged in various occupations as earners and working dependents and 49 per cent. represent the entirely dependant population. Exploitation of animals and vegetation absorbs 39 per cent. of the population which is practically the percentage for the pastoral and agricultural occupations. Next in importance are the industrial occupations which give employment to over 4 per cent. of the population. The bulk of these are, however, unorganised industries connected with the supply of ordinary necessities. Trade absorbs another 2 per cent. of the population. Of the remaining 5 per cent. insufficiently described occupations account for nearly a half, the other half being distributed in other occupations. The insufficiently described occupations represent the returns which could not be classified under any other head. The bulk of these are the general labourers who are engaged on all kinds of work which probably includes agricultural operations to a considerable extent. Transport furnishes employment to 4 persons in a thousand. Public Force and Public Administration employ respectively 5 and 6 persons per thousand while professions and domestic service occupy 5 and 8 respectively. Over 6 persons in a thousand are engaged in unproductive occupations such as beggary and vagrancy.

General Occupational Distribution of the population.

Occupational Sub-Classes.	Number per 10,000 of total population.	
	Earners following occupation as principal means of livelihood and working dependents.	Earners following occupation as subsidiary to other occupations.
1	2	3
All Occupations	5,103	437
I. Exploitation of Animals and Vegetation.	3,871	229
II. Exploitation of Minerals.	5	1
III. Industry . . .	434	70
IV. Transport . . .	40	15
V. Trade . . .	200	53
VI. Public Force . . .	51	5
VII. Public Administration.	62	10
VIII. Professions and Liberal Arts.	50	12
IX. Persons living on their income.	8	1
X. Domestic service	83	8
XI. Insufficiently described occupations.	234	23
XII. Unproductive . . .	65	10

professions and domestic service occupy 5 and 8 respectively. Over 6 persons in a thousand are engaged in unproductive occupations such as beggary and vagrancy.

Central India is pre-eminently an agricultural country many parts of which are unopened and where trade and industry have yet to be developed on modern lines. Agriculture consequently predominates overwhelmingly in every place which is evident from the diagram opposite. The Western Division is on the whole more advanced and shows a lower percentage of agricultural and pastoral population than the East. The States in the southern Bhil country and the extreme east of the Agency individually show a comparatively higher proportion. Industry, trade and other occupations prevail in a greater degree in the West than in the East. Owing to the change in the method of enumeration as already explained exact comparison with the previous figures is not possible. Some

Distribution of working population, 1931 and 1921.

Occupation.	Earners and working dependents, 1931.	Actual workers, 1921.
1	2	3
Total	100	100
1. Pasture and Agriculture.	76	68
2. Industry	9	10
3. Trade	4	5
4. Professions and Liberal Arts.	1	1
5. Others	10	16

idea as to the increase and decrease in the different classes of occupations can however be gained by comparing the proportionate distribution of the working population of 1931 with the "actual workers" of 1921. We find that agriculture has increased considerably at the expense of other occupations.

137. Working and non-working population. (i) Comparison with contiguous Provinces.—Of the 6,632,790 people enumerated in Central India 3,091,515

Proportion of earners, working dependents and non-working dependents per 1,000 of total population.

Province.	WORKING POPULATION.									Non-working dependant population.		
	Total.			Earners.			Working dependents.			Persons.	Males.	Females.
	Persons.	Males.	Females.	Persons.	Males.	Females.	Persons.	Males.	Females.			
1	2	3	4	5	6	7	8	9	10	11	12	13
Central India Agency.	511	333	178	466	315	151	45	18	27	489	180	309
Rajputana Agency.	528	343	185	375	308	67	153	35	118	472	181	291
Gwalior State	493	363	130	436	343	93	57	20	37	507	167	340
United Provinces	487	342	145	418	331	87	69	11	58	513	183	330
Central Provinces and Berar.	528	313	215	419	284	135	109	29	80	472	187	285

not vary much from that shown by the contiguous Provinces. The proportion in which the earners and working dependents are included in this working population however varies. The earners show the highest proportion in Central India and the lowest in Rajputana. The sex proportion among the working population of this Agency is 33 males to 18 females which is practically the same as for the Rajputana Agency. The Central Provinces show a lower ratio of the male workers while the United Provinces and Gwalior State exhibit a higher one. The number of males among the principal earners is about twice that of females in this Agency as well as in the Central Provinces. In Rajputana, Gwalior and the United Provinces the males are nearly 4 times as numerous as females. These proportions indicate that the women in the former Provinces take a greater share with the men in earning their livelihood. Among the dependent population the females naturally preponderate everywhere. The figures show that among the dependent workers the proportion of females is smallest in Central India and greatest in the United Provinces. The other Provinces range between these two extremes. To some extent the variations in the sex proportion may be due to the manner in which the female workers may have been treated as earner or dependent in the enumeration. In Central India the *Pardah* system is less rigid than in the United Provinces and the principal means of subsistence of the people is agriculture. The females in most places are regular workers in the fields and toil with men to an almost equal degree. In many cases the woman is a regular and whole time assistant of the cultivator throughout the agricultural season. In such cases she has not been treated as a dependent but as an earner in this Agency.

have been returned as earners, 293,296 as working dependents and 3,247,979 as non-working dependents. The proportional distribution by Sex is given in the marginal table which also shows the proportions for the contiguous Provinces. In Central India the working population comprises 51 per cent. of the total, while in 1921 it amounted to 54 per cent. The ratio does

DIAGRAM SHOWING THE PROPORTIONS OF THE INDUSTRIAL, COMMERCIAL, PROFESSIONAL AND AGRICULTURAL POPULATION IN CENTRAL INDIA AND IN SOME OF THE PRINCIPAL STATES OF THE CENTRAL INDIA AGENCY

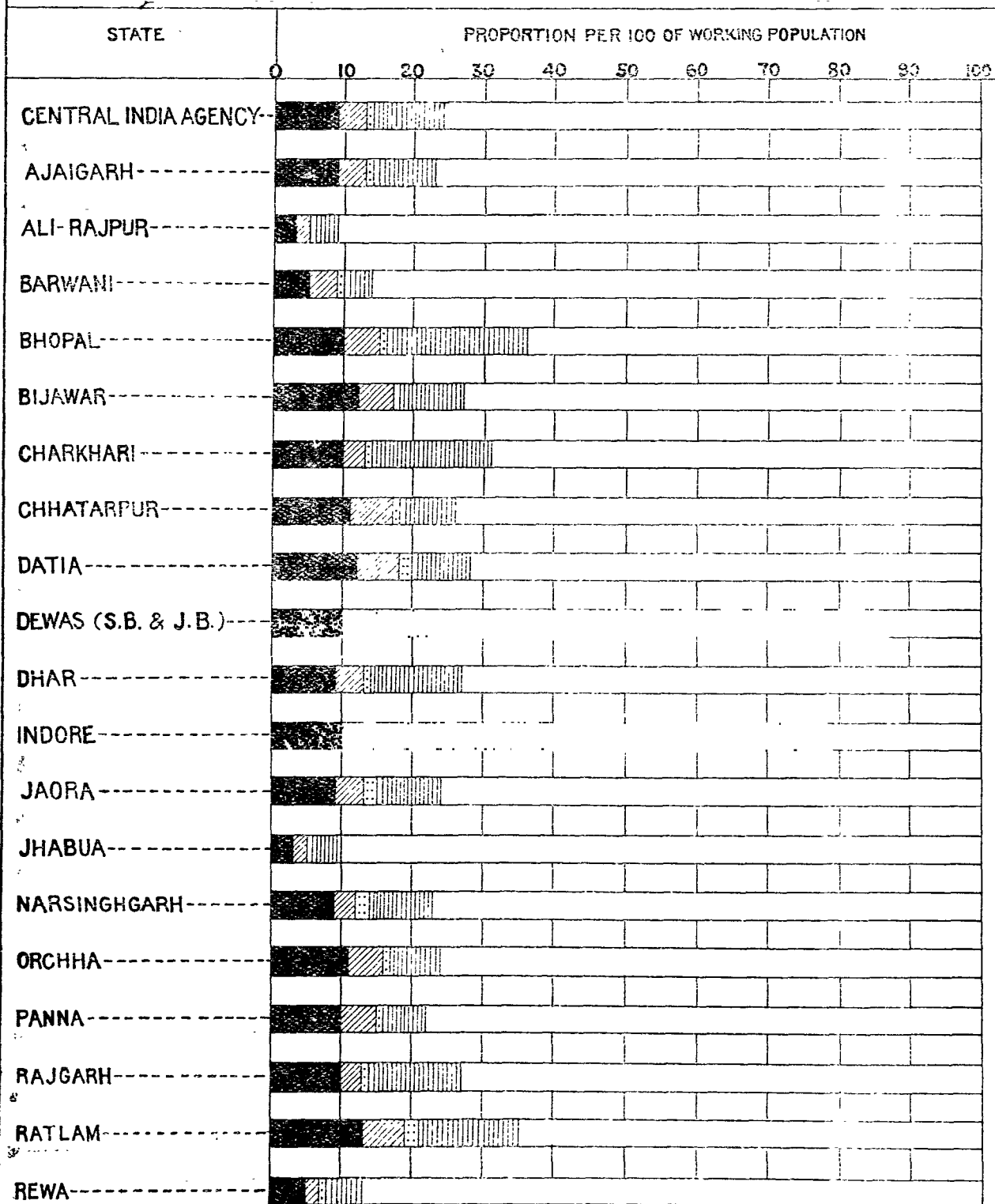

INDUSTRY [Solid Black] COMMERCE [Diagonal Lines /] PROFESSIONS [Dotted] OTHER OCCUPATIONS [Vertical Lines] AGRICULTURE [White]

138. (ii) **By principal States.**—Taking the principal States individually, Sailana shows the highest proportion of the working population being 584 per mille, whilst Charkhari with 437 per

Statement showing the proportions of Earners, Dependents and subsidiary Earners for States in Central India.

States.	PROPORTION PER 1,000 OF TOTAL POPULATION.			Proportion per cent. of earners with subsidiary occupations to total earners.
	Total earners.	Working Dependents.	Non-working Dependents.	
1	2	3	4	5
Central India Agency.	466	45	489	9
1. Indore . . .	445	50	505	8
2. Bhopal . . .	435	18	547	9
3. Khilchipur . . .	376	92	530	9
4. Narsinghgarh . . .	447	118	435	11
5. Rajgarh . . .	444	38	518	12
6. Dewas States . . .	406	34	560	9
7. Jaora . . .	375	138	487	11
8. Ratlam . . .	460	41	499	6
9. Sailana . . .	538	46	416	10
10. Sitamau . . .	474	66	460	15
11. Ali-Rajpur . . .	502	34	464	5
12. Barwani . . .	454	68	478	8
13. Dhar . . .	550	16	434	17
14. Jhabua . . .	472	53	475	6
15. Ajaigarh . . .	517	34	449	9
16. Baoni . . .	463	3	534	7
17. Bijawar . . .	438	31	531	10
18. Charkhari . . .	427	10	563	9
19. Chhatarpur . . .	483	43	474	8
20. Datia . . .	486	10	504	14
21. Orchha . . .	558	9	433	11
22. Panna . . .	527	5	468	8
23. Samthar . . .	488	10	502	16
24. Baraundha . . .	562	11	427	16
25. Maihar . . .	508	5	487	5
26. Nagod . . .	479	34	487	13
27. Rewa . . .	464	65	471	10

1,000 has the lowest proportion. The States of Ratlam, Samthar, Datia and Indore have an almost equal proportion of workers and non-workers. In 19 States out of the 27 for which figures are given in the margin the working population falls between 450 and 550 per 1,000. The burden of dependence is heavier in the States with a low proportion of workers than those with a high proportion.

For the Agency as a whole the proportion of the working dependents is 45 per 1,000 of the total population and for the individual States it ranges from 3 in Baoni to 138 in Jaora. If we arrange the figures in three groups low (below 30 per 1,000), intermediate (between 30 and 60 per 1,000) and high (above 60 per thousand), we find that the middle category which includes Indore, Rajgarh, Dewas, Ratlam, Sailana, Ali-Rajpur and Jhabua in the West and Ajaigarh, Bijawar, Chhatarpur, and Nagod in the East is fairly representative. No satis-

factory explanation is forthcoming for the very high and very low figures in certain cases. It is not at all clear why Panna should show only 5 dependent workers per mille of the population and Charkhari 10 while the intervening and intermingled territory in the Chhatarpur State shows the proportion to be 43. Similarly the difference in the figures for Maihar (5), Nagod (34) and Rewa (65) is inexplicable. The Bhopal figure of 18 working dependents per 1,000 of the population cannot be compared with the high figures returned from Khilchipur (92) and Narsinghgarh (118). Likewise, the difference between the proportions in Dhar (16) and Barwani (68) of the Southern Central India States and in Dewas (34) and Jaora (138) of Malwa is considerable. It would seem that the extent to which the enumerator has been able to follow the instructions distinguishing Earner, Working Dependent and Non-working Dependent has varied, and that in consequence the dependent workers have been treated as Earners in some cases and in others their work has been ignored altogether. The cases falling in the latter category must however be few as in a majority of States the ratio between the working and non-working population does not differ much.

Class A.—Production of Raw Materials.

139. **Production of raw materials.**—The production of raw materials is the basis of all industrial and commercial occupations. This primary industry occupies an overwhelmingly large proportion of the population everywhere in India, and in this Agency it forms the occupation in some form or other of 2,724,052 persons or 41 per cent. of the total and over 80 per cent. of the working population. About 85 per cent. of these follow the occupations in this class as their principal means of subsistence, 10 per cent. as working dependents and 5 per cent. as a secondary occupation in combination with others. This class is broadly divided into two Sub-Classes I.—Exploitation of Animals and Vegetation which practically covers the whole population engaged leaving only 4,028 persons to be employed in the other Sub-Class II.—Exploitation of minerals,

140. **Agriculture.**—Agriculture comprises 16 groups of occupations and those which are followed in this Agency are noted in the margin. It employs

Distribution of agricultural population in Central India.

Groups of occupations.	NUMBER OF PERSONS FOLLOWING OCCUPATIONS.			
	Total.	As principal occupation.	As working dependents.	As subsidiary to other occupation.
1	2	3	4	5
Agriculture.	2,549,936	2,210,810	216,868	122,258
(a) <i>Cultivation.</i>	2,533,802	2,199,431	216,381	117,990
1. Non-cultivating proprietors taking rent in money or kind.	17,618	13,959	123	3,536
2. Estate Agents and Managers of owners.	200	186	..	14
3. Estate Agents and Managers of Government (States).	122	120	..	2
4. Rent collectors, clerks, etc. . .	1,597	570	1	1,026
5. Cultivating Owners . . .	211,375	196,874	7,147	7,354
6. Tenant cultivators . . .	1,248,017	1,063,656	130,659	53,702
7. Agricultural labourers . . .	1,052,816	922,208	78,439	52,169
8. Cultivators of Jhum, taungya and shifting areas.	2,057	1,858	12	187
(b) <i>Cultivation of special crops, fruit, etc.</i>	16,134	11,379	487	4,268
13. Pan-Vine . . .	4,006	3,577	102	327
14. Market-gardeners, flower and fruit growers.	12,128	7,802	385	3,941

2,550 thousand people in its various branches. This gives a percentage of 38 on the total population and 75 on the working population. About 87 per cent. of the population engaged in agriculture have returned it as their principal occupation, 8 per cent. follow it as working dependents and 5 per cent. as a subsidiary occupation to supplement their income from other principal sources. In 1921 the population engaged in agricultural pursuits was 2,179 thousand or 36 per cent. of the total population. This means that of the actual workers 67 per cent. followed agriculture:

Occupations.	EARNERS AND WORKING DEPENDENTS, 1931.		ACTUAL WORKERS, 1921.	
	Actual number.	Proportion per 1,000 of total working population.	Actual number.	Proportion per 1,000 of total actual workers.
1	2	3	4	5
Agriculture.	2,427,678	717	2,130,523	653
(a) <i>Cultivation.</i>	2,415,812	714	2,117,780	649
1. Non-cultivating proprietors	14,082	4	11,499	4
2—4. Estate Agents, Managers, clerks, etc.	877	..	1,564	..
5. Cultivating owners . . .	204,021	61	1,435,540	440
6. Tenant cultivators . . .	1,194,315	353		
7. Agricultural labourers . . .	1,000,647	296		
(b) <i>Cultivation of special crops.</i>	11,866	3	12,743	4
13. Pan-Vine . . .	3,679	1	12,743	4
14. Market gardeners, flower and fruit growers.	8,187	2		

of which 65 as their principal means of livelihood and 2 only as a subsidiary occupation. It will be noticed that the variation in proportion is more marked in the working population than in the total population. This is due to the fact that the proportion of the working and non-working population has become more or less equal in the figures of this Census. Compared with the actual workers of 1921, the working population of the agriculturists (Earners and working dependents) shows an increase of about 14 per cent. which is about 25 per cent. greater than the general increase in population. This would suggest that the additional increase has been contributed by other occupations and greater accuracy in the record of agricultural labour is prominent in the figures. The total number of persons who maintain themselves from the rent of agricultural land is 17,618 or about 27 per ten thousand of the population. In the case of four-fifths of these it forms the principal occupation and one-fifth have recourse to it as a subsidiary means of subsistence while the number of dependents who assist in this work is negligible. As pointed out already the population of this class represents the persons who hold land from the States in *Jagir* or *Muafi* or service grants. The size of the holding varies according to the nature of the grant. The bulk of them are however small service and religious grants and in most cases the holder

cultivates the land himself or through hired labour and is classified in group 5 as a cultivating owner. Those who are classed in group 1 are the bigger Jagirdars and Muafidars who have larger holdings most of which are let out to tenants. The proportion of those living on rent of agricultural land has practically remained unchanged since the last Census. Cultivation employs 1,459,392 persons or 22 per cent. of the population. Of these 211,375 cultivate their own land and the rest are tenant cultivators. 1 per cent. of the population resort to cultivation under these two groups as a subsidiary business, 2 per cent. follow it in the capacity of working dependents and 19 per cent. as their principal occupation. The cultivating owners and tenant cultivators between them comprise 41 per cent. of the working population. The cultivators have slightly decreased since 1921 when they formed 44 per cent. of the actual workers. Agricultural labour furnishes employment to 1,000,647 persons as principal earners and working dependents and to 52,169 persons as subsidiary earners, that is to say, 15 per cent. and nearly 1 per cent. of the total population respectively. The agricultural labourers have increased considerably during the decade. In 1921 they formed about 21 per cent. of the actual workers, but now the proportion has risen to 30 per cent. Much of this increase appears to be due to a more accurate enumeration of the labourers as the returns under unspecified labour have considerably fallen. Pan-vine and Vegetables are the only special crops grown in Central India. The former is mostly confined to a few States in the East but the latter is general. Special cultivation supplies occupation to 16,134 persons about one-fourth of whom follow it as a subsidiary occupation. The returns have slightly fallen.

141. **Forestry and stock raising.**—Forestry which includes wood-cutters, charcoal burners and collectors of the jungle produce besides the departmental employees gives employment to 19,932 persons or 3 per mille of the population. Nearly two-thirds of these are earners with principal occupation and over one-third are persons whose main occupation is different and who resort to the forest as an additional source of income. In the eastern States these occupations are more prominent. The returns represent collectors of fuel, fruit and wild products from the jungle.

About 20 persons in a thousand are engaged in the raising of stock and pasturage which are closely allied to agriculture. One of these twenty follows these occupations as subsidiary to his other principal occupation and 6 as working dependents and in the case of the remainder they form the chief means of subsistence.

142. **Sub-Class II—Exploitation of minerals.**—The exploitation of minerals engages a very small proportion of the population, 3,513 as principal earners and working dependents and 514 as subsidiary earners. The minerals worked are coal, limestone and other stones, iron, diamond and ochres. Coal and iron are worked only in Rewa State while diamond is found in Panna. Only the collieries at Umaria are worked on an organised basis. Extraction of iron ores once formed an important business in some States in the East but the imported iron has now killed the industry altogether, the small returns from Rewa representing probably the Agarias—who are an off-shoot of the

Persons engaged in the extraction of minerals.

Minerals.	As principal occupation and working dependents.	As subsidiary occupation.
1	2	3
Total	3,513	514
Iron . . .	127	47
Coal . . .	1,841	126
Stone, etc. . .	1,191	238
Diamond . . .	218	25
Others . . .	136	78

Gonds and have adopted the profession of iron-smelting.

Class B.—Preparation and supply of material substances.

143. **Sub-Class III—Industry.**—The industrial population of the Agency comprises 43 per mille of the total as principal earners and working dependents and 7 per mille as subsidiary earners. With the exception of the cotton spinning and weaving mills in Indore City which have been mentioned in Chapter I and the seasonal cotton gins and presses in the main cotton growing areas of Malwa and the Narbada valley, the population of this class is engaged in unorganised industries relating to the supply of personal and household wants. The marginal table gives the distribution of the industrial population in the different Orders and also compares the proportion of the working population with the returns of 1921. Industries connected with the dress and the toilet take the first place. These include a large number of shoe-makers, barbers, tailors and washermen and are

generally well distributed. Wood industries come next and the number is swelled

Distribution of industrial population by Orders.

Orders.	PROPORTION PER 10,000 OF TOTAL POPULATION.		PROPORTION PER MILLE OF WORKING POPULATION.	
	Earners as principal occupation and working dependents.	Earners as subsidiary.	Earners as principal occupation and working dependents, 1931.	Actual workers, 1921.
1	2	3	4	5
Total .	434	70	85	101
Textiles . . .	65	9	13	15
Hides, Skins, etc. . .	9	2	2	4
Wood . . .	71	10	14	15
Metals . . .	26	5	5	6
Ceramics . . .	45	6	9	10
Chemicals . . .	20	6	4	5
Food . . .	16	2	3	4
Dress and toilet . . .	123	25	24	29
Building . . .	18	2	3	4
Others . . .	41	3	8	9

by the ordinary carpenters and bamboo workers and leaf plate makers. The Bansphors (Basors) are the chief bamboo workers and the industry is more prominent in the hilly States of the East where bamboo grows in plenty. Leaf plate making is one of the chief occupations of the Nais and Baris specially in the States of Bundelkhand and Baghelkhand. Textiles occupy the third position. 65 per 10,000 of the population are engaged in this branch of industry as principal earners and working dependents and one-seventh of this number follow it as their subsidiary occupation. Cotton spinning and weaving is the principal group under the textiles and furnishes occupation to over 72 per cent. of the total workers engaged in textile industries. The classification does not distinguish between organised mill workers and ordinary home-workers of the

Distribution of the population engaged in textile industries by States as compared with the proportion of total population.

States.	Proportion of population engaged in textile industries.	Proportion of total population.
1	2	3
Total .	1,000	1,000
Indore . . .	426	199
Rewa . . .	78	239
Orchha . . .	78	47
Bhopal . . .	60	110
Datia . . .	60	24
Dhar . . .	38	37
Dewas States . . .	20	24
Charkhari . . .	20	18
Ratlam . . .	19	16
Chhatarpur . . .	17	24
Rajgarh . . .	15	20
Barwani . . .	14	21
Nagod . . .	8	11
Other States . . .	147	210

weaving classes and the figures necessarily include a large number of workers of the latter kind. Organised spinning and weaving industry is confined to the city of Indore whereas home spinners and weavers are to be found in every place. Indore State alone accounts for nearly 43 per cent. of the total population engaged in any capacity in the textile industries while its population is only 20 per cent. of the total population of the Agency. Ceramics which practically represent the potters and brick and tile makers engage nearly 5 per cent. of the total population as principal earners and working dependents and 6 per mille as subsidiary earners. Metals employ about 3 per cent. of the population and Chemicals, Food and Building industries some 2 per cent. each while 4 per cent. are engaged in miscellaneous and undefined industries.

Compared with 1921 the industrial occupations record a fall collectively as well as individually. The earners and working dependents returned in this Sub-Class are less by 40,109 than the actual workers of 1921 which amounts to a decrease of 12 per cent. The industries connected with the textiles, metals, chemicals, food and dress and the toilet are more affected than the others. The decrease is probably due to the fact that the unorganised indigenous industries are being ousted by cheaper imported articles and some industries which were started in few States after the post-war boom have since languished due to depression and other adverse factors.

144. Sub-Class IV—Transport.—Transport employs 26,624 persons as earners and working dependents and 9,844 persons as earners having recourse to it as a subsidiary occupation. These give a proportion respectively of 40 and 15 per 10,000 of the population. Transport by Road with 17,376 principal workers and dependents and Rail with 7,596 are the two important Orders in this Sub-Class, which show an increase of 69 and 15 per cent. respectively. The greatest increase shown is in group 108—owners, managers, etc., connected with vehicles other than mechanically driven vehicles and Indore alone accounts for 37 per cent. of it.

145. Sub-Class V—Trade.—Trade supports 132,317 persons or 20 per mille of the population as principal earners and working dependents and 35,601 persons or 15 in ten thousand follow it as a subsidiary means of livelihood. In the previ-

ous Census 153,132 persons were employed in commercial occupations as actual

Commercial population in different Orders compared with 1921.

Form of trade.	Number engaged as earners (principal occupation) and working dependents (00's omitted).	Variation per cent. from the number of actual workers in 1921.
1	2	3
Total	1,323	-13.5
Banks, credit, exchange, etc.	77	-5.3
Brokerage, commission.	15	-38.1
Textiles . . .	79	-2.0
Skins, etc. . . .	7	+31.7
Wood	14	+189.1
Metals	7	+32.9
Pottery, bricks and tiles.	15	+2,533.3
Chemical products .	18	-15.6
Hotels, etc. . . .	32	-18.5
Other trade in foodstuffs.	762	-21.1
Clothing and toilet .	36	+491.9
Furniture	6	+230.2
Building materials .	5	+125.6
Means of transport	14	-73.2
Fuel	59	-13.4
Articles of luxury, etc.	55	+17.9
Other sorts . . .	123	-4.4

workers, that is to say, there has been a decrease of nearly 14 per cent. during the past decade. Business in foodstuffs employs more than half the population engaged in trade, bankers, brokers and commission agents comprise 7 per cent., cloth merchants 6 per cent. and dealers in fuel over 4 per cent. Articles of luxury and pertaining to letters and the arts and sciences engage 4 per cent. and hotels, etc., and trade in clothing and toilet articles together employ 5 per cent. while trade in wood, pottery, bricks and tiles, and means of transport accounts for another 3 per cent. The remaining 13 per cent. are employed in various other branches of business. The trade in foodstuffs which is numerically the most important Order in this Sub-Class records a fall of 21 per cent. Grain and pulse merchants have suffered less seriously than others while the dealers in sweetmeats, spices, etc., have considerably increased. The dealers in dairy products, eggs, etc. and fodder for animals show a noticeable fall while those trading in other foodstuffs contribute to the decrease in the largest number. The world-wide economic depression that has

been prevailing of recent years has affected the trading classes seriously everywhere and Central Indian States could not have been able to enjoy immunity from it.

The marginal table shows for certain principal States the distribution by Orders of the population engaged in trade as earners and working dependents. In Central

Distribution of commercial population by Orders for certain States.

State.	Number of earners (principal occupation) and working dependents engaged in trade per mille of total population.	Order 23 Banks, Insurance, etc.	Order 25 Textiles.	Order 32 Foodstuffs.	Order 37 Fuel.	Order 38 Articles of luxury. Letters and Arts, etc.	Others.
1	2	3	4	5	6	7	8
Ratlam	56	8	7	23	1	2	15
Bhopal	51	1	3	28	1	2	16
Dewas	49	3	3	17	1	2	23
Indore	47	4	4	18	2	3	16
Jaora	45	5	5	22	1	3	9
Barwani	38	5	3	25	1	1	3
Dhar	36	5	3	22	..	1	5
Rajgarh	27	2	1	20	1	1	2
Narsinghgarh . . .	25	4	2	15	1	1	2
Ali-Rajpur	15	1	1	10	3
Datia	65	2	2	45	5	2	9
Chhatarpur	58	4	2	42	4	2	4
Orchha	50	3	2	29	2	2	12
Panna	47	1	2	35	5	1	3
Bijawar	45	3	1	31	7	..	3
Maihar	35	..	3	28	2	2	..
Nagod	35	1	1	18	9	2	4
Rewa	24	..	1	17	1	1	4
Charkhari	23	1	2	17	1	2	..

India as a whole 39 per mille of the working population is employed in commercial pursuits, the proportions for the Natural Divisions being 42 and 36 for West and East respectively. Ratlam shows the highest proportion, 56 per mille, in the West and Datia with 65 per mille heads the list in the East. Ali-Rajpur in Bhil country

shows the smallest figure in the Agency as well as in the West while Charkhari is the least commercial in the East. The town of Ratlam which comprises more than one-third of the total population of the State and which is an important Railway junction is apparently responsible for the position occupied by the State in relation to trade.

Dealers in foodstuffs are by far the most numerous among the businessmen. In almost all the States in the East and in Bhopal and Southern States Agencies

in the West, they represent more than a half of the total population engaged in trade. Dealers in fuel are more prominent in the eastern States, while bankers and cloth merchants show a greater proportion in Malwa and Southern States.

The methods of marketing and distribution are still primitive and they are handicapped by want of communications. The chief source of distribution are the *Hats* or weekly markets. They are of varying sizes but no statistics were obtained as the States possess no accurate information about them.

Class C.—Public Administration and Liberal Arts.

146. Public Force and Administration.—About 108 thousand persons are engaged in this class as principal earners and working dependents and some

Public Force and Administration.

Occupations.	EARNERS AS PRINCIPAL OCCUPATION AND WORKING DEPENDENTS.		Earners as subsidiary occupation. Actual figures (00's omitted).	Variation per cent. from Actual workers in 1921.
	Actual figures (00's omitted).	Proportion per mille of total population.		
1	2	3	4	5
Public Force	337	5	32	—16.3
Army	150	2	4	—26.9
Police	187	3	28	—5.5
Public Administration.	413	6	66	—18.0

18 thousand as subsidiary earners. Nearly 70 per cent. of the former and 37 per cent. of the latter find employment in Public Force and Administration and the rest are engaged in professions and liberal arts. Public Force employs about 5 per mille of the total population. Two per mille of these are employed in the Army and 3 in the Police and as Village watchmen. Five-sixths of the returns under the Army represent the troops in the Indian States. Compared with the actual workers in 1921, Army shows a fall of nearly 27 per cent. and in the case of the Imperial Army it amounts to 48 per cent. This is due to the abandonment of Sehore (Bhopal State) as a military station and the reduction of the military at Mhow and Nowgong Cantonments. The Police which includes the Village watchmen shows a decrease of 5.5 per cent. Police proper has increased by about 13 per cent. but the returns under Village watchmen have gone down by 32 per cent. The decrease in the number of Village watchmen is probably due to the fact that persons who have returned the work as their subsidiary occupation this time were not separately recorded in 1921 and were probably included amongst the actual workers. If they are taken into account the decrease is reduced to 10 per cent. About 6 per mille of the population is engaged in Public Administration, some two-thirds of them being employed in Municipal and Village services. Public Administration records a fall of about 18 per cent. The present abnormal conditions are not favourable to the development and expansion of the administrative machinery and further reductions are likely to take place in the future.

147. Professions and Liberal Arts.—Professions and Liberal Arts give employment to some 33 thousand persons or 5 per mille of the population as

Professions and Liberal Arts.

Occupations.	EARNERS AS PRINCIPAL OCCUPATION AND WORKING DEPENDENTS.		Earners as subsidiary occupation. Actual figures (00's omitted).	Variation per cent. from Actual workers in 1921.
	Actual figures (00's omitted).	Proportion per mille of total population.		
1	2	3	4	5
Professions and Liberal Arts.	328	5	81	—1.0
Religion	134	2	50	—22.4
Law	11	..	1	+33.0
Medicine	38	..	5	+33.3
Instruction	54	..	3	+59.6
Letters, Arts and Sciences.	91	1	22	—4.3

principal earners and working dependents and about one-fourth of this number follow them as their supplementary occupation. This sub-class of occupations as a whole has practically maintained its previous strength, Religion being the principal loser and Law, Medicine and Instruction the chief gainers. Law and Medicine individually maintain 2 and 6 per 10,000 of the people while Instruction provides employment for another 8. The number of persons who resort to these professions as a secondary vocation is small. Law and Medicine which show

an increase of 33 per cent. each have been gaining in popular esteem and the recent opening of law classes in the Colleges at Indore is sure to swell the number of lawyers. The medical school in the Indore Residency attracts students from long distances. Except in Indore City *cum* Residency and Mhow Cantonment where these professions may appear to be overcrowded owing to the large number of qualified doctors and legal practitioners, the bulk of the returns are representative of ordinary Mukhtiar and petition-writers and the practitioners of indigenous methods of medicine and midwifery in the rural parts. Instruction which forms the chief occupation of 8 per 10,000 of the population shows an increase of nearly 60 per cent. over the figures of 1921. This is good evidence of the progress of education during the decade which is corroborated by the figures for the literate. Letters, Arts and Sciences engage one per mille of the population as principal earners and working dependents and another one-fourth of this number have these as their additional occupation. Musicians, singers, dancers, etc., constitute more than three-fourths of them.

Class D.—Miscellaneous.

148. **Miscellaneous.**—The miscellaneous occupations grouped under this class form the chief vocation of 259,000 earners and working dependents and the

Miscellaneous Occupations.

Occupations.	EARNERS AS PRINCIPAL OCCUPATION AND WORKING DEPENDENTS.		Earners as subsidiary occupation. Actual figures (00's omitted).	Variation per cent. from Actual workers in 1921.
	Actual figures (00's omitted).	Proportion per mille of total population.		
1	2	3	4	5
Miscellaneous	2,585	39	280	-36.7
Persons living on their income.	53	1	5	-3.5
Domestic service	548	8	56	-11.2
Motor Drivers and Cleaners.	11	+215.3
Other Domestic service.	537	..	56	-12.5
Insufficiently described occupations.	1,552	23	154	-44.1
Labourers, etc.	1,468	22	148	-45.8
Unproductive	432	7	65	-32.0
Inmates of jails, etc.	29	-7.9
Beggars, Vagrants, Prostitutes.	402	6	65	-32.6

secondary calling of 28 thousand other earners. The former bear a proportion of 39 per mille to the total population and the latter represent 4 per mille. The class records a fall of 37 per cent. since the previous enumeration and this is mainly due to the big drop in the returns of unspecified labour. The number of persons living on their income has slightly decreased. This head includes Government and State pensioners and a large number of maintenance allowance holders. Compared with the Rajputana Agency and Gwalior State Central India shows a higher proportion of such persons. Under Domestic service private motor drivers and cleaners have more than trebled themselves whilst

other domestic servants have decreased by over 12 per cent. The use of automobiles and the extension of the facilities of motor transport in the rural parts

Comparative figures for persons living on their income.

Agency or State.	Earners as principal occupation and working dependents.	Earners as subsidiary occupation.	Total.	Proportion per 10,000 of the total population.
1	2	3	4	5
Central India Agency.	5,268	463	5,731	9
Rajputana Agency	5,771	1,112	6,883	6
Gwalior State	1,250	489	1,739	5

have considerably increased during the decade. The returns of insufficiently described occupations have fallen by 44 per cent., which points to the more careful record of labourers who usually swell the returns under this Order. About six-sevenths of the returns under the head Unproductive consist of beggars, vagrants and prostitutes. There is a drop of about 33 per cent. among the beggars and vagrants and a rise of about 15 per cent. among the prostitutes. The former is in part due to the inclusion of wizards, witches, etc., in that group in 1921, while for the increase in the number of prostitutes the vagaries of enumeration are apparently responsible. The prostitutes usually pass as singers and dancers and their number is liable to fluctuation according to the manner in which they are returned at each Census.

Section III.—Some general points.

149. **Industrial Census.**—In 1911 and 1921 certain information relating to organised industrial concerns was collected on special schedules filled up by the managers. This being considered inadequate and a complete and efficient census of industry being too onerous an undertaking to be combined with the general Census, the Government of India decided not to undertake any industrial census on this occasion. Only a column for industry was added in the General Schedule. The information was recorded in this Agency, but in order to curtail certain amount of statistical output it was not tabulated and compiled, although a few States like Indore and Dhar, elected to tabulate it for local purposes and the results are exhibited in the Census Reports of the States concerned.

150. **Census of Educated unemployment.**—An unsuccessful attempt to take the census of educated unemployment was made for the first time at this Census. In the chapter on Literacy it has been pointed out that the problem does not exist in many parts of the Agency and the census was a failure in the only place where any results were possible.

151. **Occupation by Caste and Religion, combined Occupations and Occupations subsidiary to Agriculture.**—The occupations of selected castes

Occupational Sub-Class.	EUROPEAN AND ALLIED RACES.			ANGLO-INDIANS.		
	Persons.	Males.	Fe-males.	Per-sons.	Males.	Fe-males.
1	2	3	4	5.	6	7
Population dealt with	2,477	1,836	641	736	390	346
<i>Earners and working dependents</i>	1,727	1,611*	116	243	208	35
<i>Non-working dependents</i>	750	225	525	493	182	311
I. Exploitation of Animals and Vegetation.	4	4	..
II. Exploitation of Minerals	1	1
III. Industry	10	8	2	7	7	..
IV. Transport	56	55	1	126	124	2
V. Trade	12	10	2	7	7	..
VI. Public Force	1,413	1,413	..	8	8	..
VII. Public Administration	38	33	5	24	21	3
VIII. Professions and Liberal Arts.	162	61	101	34	11	23
IX. Persons living on their income.	11	10	1	14	8	6
X. Domestic service	18	14	4	14	14	..
XI. Insufficiently described occupations.	5	5	..	5	4	1

* Includes 1 working dependent.

Commissioner for India. The figures are noted in the marginal table. The tables showing the subsidiary occupations of the different classes of agriculturists and the extent to which certain combined occupations, such as shepherd and blanket-weaver and cattle-breeder and milkman, are followed as principal and subsidiary occupation, have been abandoned on this occasion, in pursuance of the policy of economy.

152. **Occupations of the Females.**—Subsidiary Table III appended to this Chapter gives by Sub-Classes and selected Orders and Groups the absolute statistics relating to the female workers as well as their proportion to male workers which is also illustrated in the map below. The marginal table sets out comparative proportional figures for 1931 and 1921 for the more important occupations. Over 36 per cent. of the females contribute to the working population in Central India leaving 64 per cent. as entirely dependent. In 1921 the women workers constituted nearly 43 per cent. of their total strength. Agricultural and pastoral occupations absorb five-sixths of the female workers, field labour being most favourite with them. Industry provides employment to two per cent. of the females, and basket-making, etc., employs the largest number—about one-fifth of the total engaged in industrial occupations. Pottery, cotton spinning, washing and cleaning, manufacture and refining of vegetable oils and flour-grinding are the other important industrial occupations of the women folk. The proportion of females is highest—more than six times as large as that of the males—among the rice pounders, flour grinders, etc. The proportion of females among the oil pressers and washers and cleaners is over 50 per cent. of the males. Cotton spinning as a home industry forms a useful employment of the women in many rural areas, but their proportion is obscured by the inclusion of weavers, etc., in that group

have not been tabulated for this Agency. The table was optional and was not considered to be of sufficient local importance. Moreover as the Occupation table had already become very bulky it was considered undesirable to load the Tables volume with further elaborate occupational tables. The occupations followed by the European and Allied Races and the Anglo-Indians were however sorted out and supplied to the Census

Trade employs about 1 per cent. of the female population. Foodstuffs and fuel

Female Occupations.

Occupations.	Proportion of earners (principal occupation) and working dependents per 10,000 of female population, 1931.	Actual workers per 10,000 of female population, 1921.	NUMBER OF FEMALES PER 1,000 MALES.	
			1931.	1921.
1	2	3	4	5
All Occupations	3,645	4,264	433	620
I. Exploitation of animals and Vegetation.	2,964	3,041	591	667
I. Pasture and agriculture	2,963	3,039	590	667
<i>Cultivating Owners</i>	114	1,651	219	508
<i>Tenant Cultivators</i>	995		368	
<i>Agricultural labourers</i>	1,768	1,313	1,326	1,329
III. Industry	206	338	300	431
5 Textiles	34	65	342	615
<i>Cotton spinning, etc.</i>	23	50	311	635
7 Wood	41	57	390	314
<i>Basket, etc., makers</i>	40	53	830	1,054
9 Ceramics	30	41	489	594
10 Chemical products	15	26	535	779
<i>Manufacture and refining of vegetable oils.</i>	14	24	559	792
11 Food industries	14	25	659	1,144
<i>Rice pounders, grinders</i>	9	15	6,224	9,349
12 Dress and the Toilet	36	66	164	261
<i>Washing and cleaning</i>	16	27	612	705
V. Trade	115	177	388	510
32 Foodstuffs	82	138	530	656
37 Fuel	10	14	1,355	1,590
VIII. Professions and Liberal Arts	15	22	161	234
47 Medicine	5	4	717	791
<i>Midwives, etc.</i>	4	4	1,326	1,799
49 Letters, Arts and Sciences	6	9	254	404
<i>Musicians, etc.</i>	5	8	294	530
X. Domestic service	53	80	458	611
XI. Insufficiently described occupations.	238	505	983	1,142
<i>Labourers, etc.</i>	237	502	1,086	1,189
XII. Unproductive	35	70	356	474
<i>Beggars, Vagrants</i>	34	66	345	487

are the chief articles in which they deal. Of the professions and liberal Arts, midwifery and music are the principal means of their employment. Domestic service occupies only 5 women in a thousand, while the returns under unspecified labour amount to some 24 per mille. Compared with 1921 the proportion of the female working population has fallen by about 7 per cent. The decrease is distributed in almost all kinds of their occupations other than those connected with pasture and agriculture where they are practically as numerous as before. Of the women earners 33 per mille have returned a secondary occupation as well. The nature of the occupations which are followed as a subsidiary means of livelihood is generally the

same as in the case of their principal vocation.

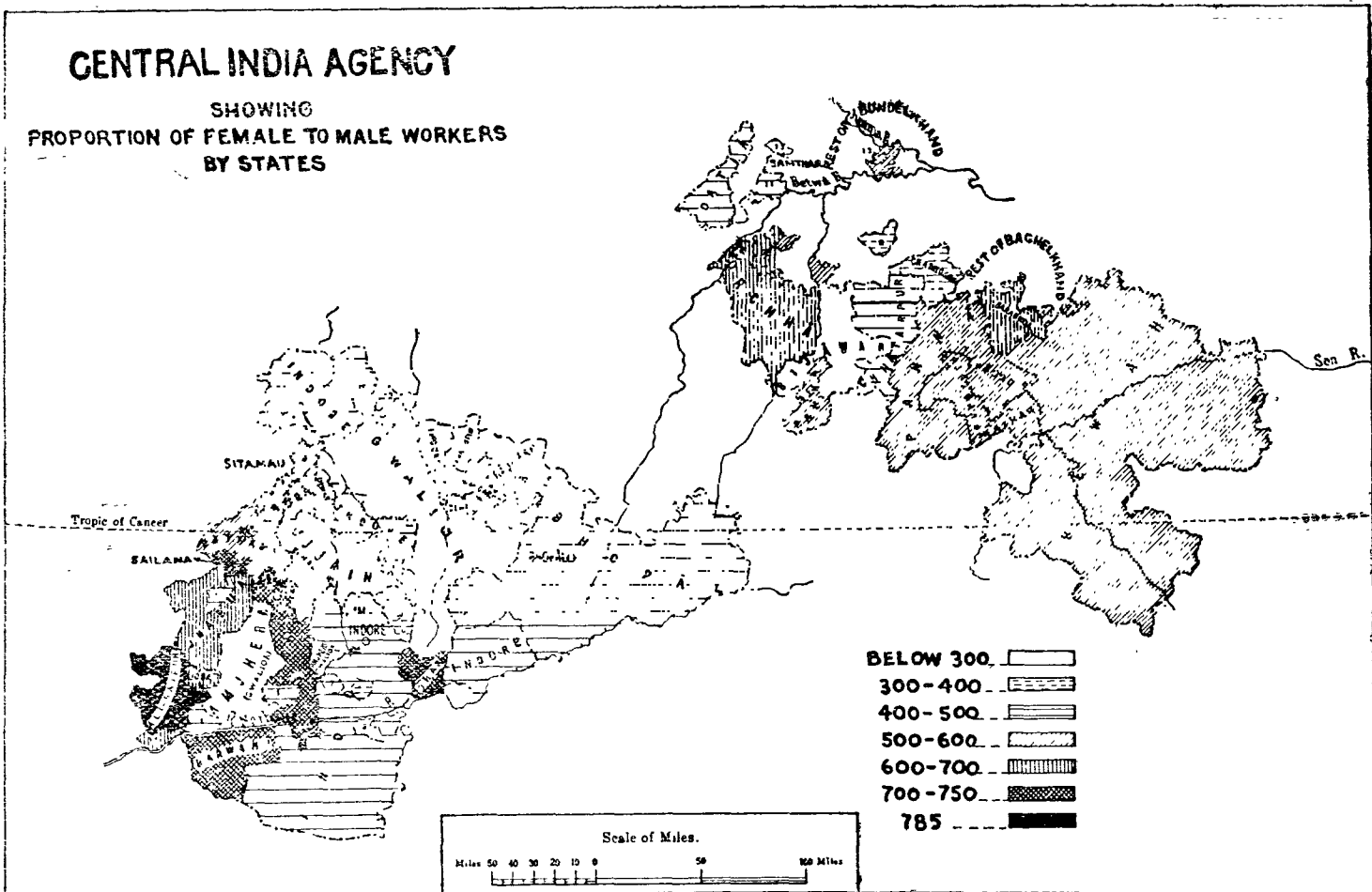

153. **Subsidiary Occupations of Earners.**—Information as to the subsidiary employments of the people was not available in the previous Census except

Occupational distribution of earners (as subsidiary Occupation).

Occupations.	Proportion of earners (as subsidiary Occupation) per 10,000 of total population.	DISTRIBUTION OF 1,000 EARNERS.	
		As subsidiary occupation.	As principal occupation.
1	2	3	4
All Occupations	437	1,000	1,000
I. Exploitation of Animals and Vegetation.	229	524	745
Pasture and Agriculture	223	510	744
II. Exploitation of Minerals	1	2	1
III. Industry	70	159	91
Textiles	9	21	14
Wood	10	24	15
Dress and the toilet	25	57	26
IV. Transport	15	34	8
V. Trade	53	123	42
Banks, credit, etc.	10	23	2
Foodstuffs	30	69	24
VI & VII. Public Force and Administration.	15	34	24
VIII. Professions and Liberal Arts	12	28	10
Religion	8	17	4
Letters, Arts and Sciences	3	8	3
IX. Persons living on their income	1	2	2
X. Domestic service	8	19	17
XI. Insufficiently described occupations.	23	53	47
XII. Unproductive	10	22	13
Beggars, Vagrants and Prostitutes	10	22	12

as regards the agricultural occupations which alone were then tabulated. The extent to which the various kinds of occupations form the secondary source of income will be evident from the Subsidiary Table I(b) which gives the general occupational distribution of the earners (as subsidiary occupation). The figures for Sub-Classes and selected Orders are reproduced in the marginal table which also compares the distribution of 1,000 persons who follow the different occupations as their principal and subsidiary employment. 437 per 10,000 of the population or 9 per cent. of the total earners have returned a secondary occupation. Pastoral and agricultural pursuits absorb more than a half of these. Industries account for 16 per cent. of them, those connected with dress and the toilet engaging the largest number, nearly 6 per cent. Textile and wood industries form the subsidiary occupation of over 2 per cent. each. Trade as a subsidiary calling is followed by 5 per mille of the population or 12 per cent. of the subsidiary earners, trade in foodstuffs engaging more than half the number. In the case of about 3 per cent. of the subsidiary earners Public Force or Administration has been returned as a secondary pursuit. Village watchmen and other village services are the chief groups in which they occur. Professions and Liberal Arts furnish a secondary employment to another 3 per cent. of the subsidiary earners. Letters, arts and the sciences and religion are numerically the most important Orders in this Sub-Class. 8 per 10,000 of the population have domestic service for their subsidiary calling while in the case of 23 per mille the nature of their subsidiary occupation is insufficiently described. A comparison of the figures in columns 3 and 4 of the marginal table discloses that in almost all non-agricultural occupations the subsidiary earners proportionately out-number the principal earners which points to the all importance of agricultural occupation in Central India.

SUBSIDIARY TABLE I (a).

General distribution of occupation.

Earners (Principal Occupation) and working dependents.

Class, Sub-Class and Order.	No. per 10,000 of total population.	PERCENTAGE RECORDED IN	
		Cities and Urban industrial areas.	Rural areas.
1	2	3	4
Non-working dependants	4,897	4-23	95-77
All occupations (Earners and working dependants.)	5,103	2-61	97-39
A. Production of raw materials	3,876	-18	99-82
I. Exploitation of animals and vegetation	3,871	-18	99-82
1. Pasture and Agriculture	3,865	-18	99-82
(a) Cultivation	3,642	-14	99-86
(b) Special crops	18	3-07	96-93
(c) Forestry	20	3-24	96-76
(d) Stock Raising	183	-27	99-73
(e) Raising of Insects	2	..	100-00
2. Fishing and Hunting	6	2-43	97-57
II. Exploitation of Minerals	5	-91	99-09
3. Metallic Minerals	100-00
4. Non-Metallic Minerals	5	-95	99-05
B. Preparation and supply of material substances	674	10-04	89-96
III. Industry	434	9-54	90-46
5. Textiles	65	29-66	70-34
6. Hides, Skins and hard materials from the animal kingdom	9	-79	99-21
7. Wood	71	3-78	96-22
8. Metals	26	7-92	92-08
9. Ceramics	45	2-64	97-36
10. Chemical products properly so-called and analogous	20	2-02	97-98
11. Food industries	16	12-55	87-45
12. Industries of dress and toilet	123	5-46	94-54
13. Furniture industries	1	12-74	87-26
14. Building industries	18	6-56	93-44
15. Construction of means of transport	..	62-77	37-23
16. Production and transmission of physical force	1	44-66	55-34
17. Miscellaneous and undefined Industries	39	10-58	89-42
IV. Transport	40	17-18	82-82
18. Transport by air
19. Transport by water	1	..	100-00
20. Transport by road	26	12-18	87-82
21. Transport by rail	11	28-66	71-34
22. Post Office, Telegraph and Telephone services	2	24-16	75-85
V. Trade	200	9-69	90-31
23. Banks, establishments of credit, exchange and Insurance	12	7-18	92-82
24. Brokerage commission and export	2	33-93	66-07
25. Trade in textiles	12	19-03	80-97
26. Trade in leather and furs	1	4-30	95-70
27. Trade in wood	2	3-58	96-42
28. Trade in metals	1	19-66	80-34
29. Trade in pottery, bricks and tiles	2	1-60	98-40
30. Trade in chemical products	3	9-76	90-24
31. Hotels, Cafes, Restaurants, etc.	5	24-50	75-50
32. Other trade in food stuffs	115	7-32	92-68
33. Trade in clothing and toilet articles	5	10-97	89-03
34. Trade in furniture	1	40-87	59-13
35. Trade in building materials	1	17-15	82-85
36. Trade in means of transport	2	27-28	72-72
37. Trade in fuel	9	23-58	76-42
38. Trade in articles of luxury and pertaining to letters and the arts and sciences.	8	20-96	79-04
39. Trade in other sorts	19	9-05	90-95
C. Public Administration and Liberal arts	163	15-27	84-73
VI. Public Force	51	16-46	83-54
40. Army	23	24-65	75-35
41. Navy
42. Air Force
43. Police	28	10-03	89-97
VII. Public Administration	62	16-20	83-80
44. Public Administration	62	16-20	83-80
VIII. Professions and Liberal Arts	50	12-84	87-16
45. Religion	20	7-10	92-90
46. Law	2	26-16	73-84
47. Medicine	6	17-52	82-48
48. Instruction	8	22-32	77-68
49. Letters and Arts and Sciences	14	12-30	87-70
D. Miscellaneous	390	8-71	91-29
IX. Persons living on their income	8	35-99	64-01
50. Persons living principally on their income	8	35-99	64-01
X. Domestic service	83	14-95	85-05
51. Domestic service	83	14-95	85-05
XI. Insufficiently described Occupations	234	6-29	93-71
52. General terms which do not indicate a definite occupation	234	6-29	93-71
XII. Unproductive	65	6-14	93-86
53. Inmates of Jails, Asylums and Alms houses	4	28-66	71-34
54. Beggars, Vagrants, Prostitutes	61	4-28	95-72
55. Other unclassified non-productive Industries	..	80-05	19-95

SUBSIDIARY TABLE I (b).
General distribution of occupation.
(Earners as Subsidiary Occupation).

Class, Sub-Class and Order.	No. per 10,000 of total population.	PERCENTAGE RECORDED IN	
		Cities and Urban industrial areas.	Rural areas
1	2	3	4
All Occupations (Earners as subsidiary occupation.)	437	61	99.39
A. Production of raw materials	230	15	99.85
I. Exploitation of animals and vegetation	229	16	99.84
1. Pasture and Agriculture	223	14	99.86
(a) Cultivation	178	14	99.86
(b) Special crops	7	07	99.93
(c) Forestry	10	50	99.50
(d) Stock Raising	14	10	99.90
(e) Raising of Insect, etc.	14	..	100.00
2. Fishing and Hunting, etc.	6	79	99.21
II. Exploitation of Minerals	1	1.15	98.85
3. Metallic Minerals	100.00
4. Non-Metallic Minerals	1	1.28	98.72
B. Preparation and supply of material substances	138	97	99.03
III. Industry	70	65	99.35
5. Textiles	9	1.11	98.89
6. Hides, Skins and hard materials from the animal kingdom	2	15	99.85
7. Wood	10	45	99.55
8. Metals	5	73	99.27
9. Ceramics	6	28	99.72
10. Chemical products properly so-called and analogous	6	14	99.86
11. Food industries	2	2.48	97.52
12. Industries of dress and toilet	25	58	99.42
13. Furniture industries	100.00
14. Building industries	2	1.81	98.19
15. Construction of means of transport	100.00
16. Production and transmission of physical force	..	5.88	94.12
17. Miscellaneous and undefined Industries	3	67	99.33
IV. Transport	15	2.04	97.96
18. Transport by air
19. Transport by water	1	32	99.68
20. Transport by road	14	1.95	98.05
21. Transport by rail	..	9.24	90.76
22. Post Office, Telegraph and Telephone services	100.00
V. Trade	53	1.09	98.91
23. Banks, establishments of credit, exchange and Insurance	10	65	99.35
24. Brokerage commission and export	..	3.88	96.12
25. Trade in textiles	2	2.88	97.12
26. Trade in skins, leather and furs	..	1.23	98.77
27. Trade in wood	1	21	99.79
28. Trade in metals	..	1.45	98.55
29. Trade in pottery, bricks and tiles	100.00
30. Trade in chemical products	1	1.71	98.29
31. Hotels, Cafes, Restaurants, etc.	1	2.14	97.86
32. Other trade in food stuffs	30	82	99.18
33. Trade in clothing and toilet articles	..	6.75	93.25
34. Trade in furniture	100.00
35. Trade in building materials	100.00
36. Trade in means of transport	1	1.47	98.53
37. Trade in fuel	4	1.40	98.60
38. Trade in articles of luxury and pertaining to letters and the arts and sciences.	1	6.00	94.00
39. Trade in other sorts	2	1.78	98.22
C. Public Administration and Liberal arts	27	1.15	98.85
VI. Public Force	5	22	99.78
40. Army	1	1.03	98.97
41. Navy
42. Air Force
43. Police	4	11	99.89
VII. Public Administration	10	92	99.08
44. Public Administration	10	92	99.08
VIII. Professions and Liberal Arts	12	1.70	98.30
45. Religion	8	74	99.26
46. Law	..	6.48	93.52
47. Medicine	1	3.01	96.99
48. Instruction	..	1.82	98.18
49. Letters and Arts and Sciences	3	3.39	96.61
D. Miscellaneous	42	1.56	98.44
IX. Persons living on their income	1	25.27	74.73
50. Persons living principally on their income	1	25.27	74.73
X. Domestic service	8	1.81	98.19
51. Domestic service	8	1.81	98.19
XI. Insufficiently described Occupations	23	1.19	98.81
52. General terms which do not indicate a definite occupation	23	1.19	98.81
XII. Unproductive	10	54	99.46
53. Inmates of Jails, Asylums and Alms houses
54. Beggars, Vagrants, Prostitutes	10	54	99.46
55. Other unclassified non-productive Industries	100.00

SUBSIDIARY TABLE II (a).

Occupation.

Agency, Natural Divisions and States.	TOTAL 1,000.			NO. PER MILLE OF THE TOTAL POPULATION OCCUPIED AS EARNERS (PRINCIPAL OCCUPATION) AND WORKING DEPENDENTS IN											
	Nonworking dependents.	Working dependents.	Earners Principal Occupation.	Sub-class I.—Exploitation of animals and vegetation.	Sub-class II.—Exploitation of Minerals.	Sub-class III.—Industry.	Sub-class IV.—Transport.	Sub-class V.—Trade.	Sub-class VI.—Public Force.	Sub-class VII.—Public Administration.	Sub-class VIII.—Professions and liberal arts.	Sub-class IX.—Persons living on their income.	Sub-class X.—Domestic service.	Sub-class XI.—Insufficiently described occupation.	Sub-class XII.—Unproductive.
1	2	3	4	5	6	7	8	9	10	11	12	13	14	15	16
CENTRAL INDIA AGENCY	490	44	466	759	1	85	8	39	10	12	10	1	16	46	13
West	504	46	450	712	..	90	10	42	11	17	14	3	18	66	17
British Pargana of Manpur	487	17	496	712	..	71	35	56	12	31	19	..	13	41	10
<i>Indore Residency.</i>															
Indore	505	50	445	670	1	100	12	47	13	18	17	3	18	85	16
<i>Bhopal Agency.</i>															
Bhopal	547	18	435	644	..	96	8	51	11	15	8	4	28	113	22
Khilehipur	532	92	376	776	..	110	4	29	10	16	13	1	10	3	28
Narsingharh	435	118	447	769	1	92	4	25	10	26	14	2	9	28	20
Rajgarh	518	38	444	736	1	106	6	27	13	26	14	2	11	31	24
<i>Malwa Agency.</i>															
Dewas States	560	34	406	695	..	108	7	49	18	28	23	2	14	30	26
Jaora	487	137	376	759	..	88	11	45	9	19	18	4	17	14	16
Raṭlam	499	41	460	651	..	127	42	56	10	11	25	2	32	31	13
Sailana	416	46	538	773	..	80	10	42	13	14	22	1	13	13	19
Sitamau	460	66	474	721	..	102	7	45	13	16	28	1	30	13	24
<i>Southern Central India States Agency.</i>															
Ali-Rajpur	464	34	502	911	..	29	6	15	5	7	2	..	6	15	4
Barwani	478	68	454	866	..	53	5	38	6	12	5	1	5	1	8
Dhar	434	16	550	742	..	85	9	36	9	20	13	1	10	60	15
Jhabua	475	53	472	897	..	28	3	19	4	9	4	..	10	20	6
Jobat	483	123	394	902	..	18	4	39	5	7	5	1	9	6	4
East	474	42	484	805	2	80	6	36	9	7	6	1	14	25	9
<i>Bundelkhand Agency.</i>															
Ajaigarh	449	33	518	766	..	93	4	43	11	10	6	1	21	34	11
Baoni	534	3	463	760	..	102	3	43	1	19	9	3	26	25	9
Bijawar	531	31	438	732	..	119	4	45	11	10	6	1	11	52	9
Charkhari	563	10	427	695	..	101	2	23	18	9	10	5	18	112	7
Chhatarpur	474	43	483	737	..	117	7	58	21	11	10	1	22	8	8
Datia	504	10	486	719	..	124	6	65	26	16	18	1	13	1	11
Orchha	433	9	558	765	..	114	5	50	6	7	7	1	16	22	7
Panna	467	6	527	785	2	99	4	47	6	9	6	1	22	10	9
Samthar	502	10	488	638	1	146	6	61	61	18	16	..	21	20	12
<i>Baghelkhand Agency.</i>															
Baraundha	427	11	562	899	..	39	..	27	7	3	2	..	8	12	3
Kothi	469	14	517	817	..	84	9	40	10	7	6	1	17	..	9
Maithar	487	5	508	779	7	102	5	37	14	8	6	..	9	20	13
Nagod	487	34	479	551	..	88	6	35	8	6	7	1	14	269	15
Rewa	471	65	464	870	3	53	6	24	4	5	3	..	11	13	8
Sohawal	497	23	480	801	2	87	9	40	6	6	6	1	16	16	10

NOTE.—East includes Khaniadhana figures.

SUBSIDIARY TABLE II (b).

Subsidiary Occupation.

Agency, Natural Divisions and States.	NUMBER PER MILLE OF TOTAL POPULATION OF EARNERS HAVING A SUBSIDIARY OCCUPATION IN											
	Sub-class I.	Sub-class II.	Sub-class III.	Sub-class IV.	Sub-class V.	Sub-class VI.	Sub-class VII.	Sub-class VIII.	Sub-class IX.	Sub-class X.	Sub-class XI.	Sub-class XII.
1	2	3	4	5	6	7	8	9	10	11	12	13
CENTRAL INDIA AGENCY	524	2	159	34	123	11	23	28	2	19	53	22
West	493	..	111	47	136	13	41	29	2	16	75	37
British Pargana of Manpur	450	..	15	295	178	..	26	4	7	8	14	3
<i>Indore Residency.</i>												
Holkar State	449	..	131	43	123	9	53	35	3	19	97	38
<i>Bhopal Agency.</i>												
Bhopal	520	..	102	32	111	16	16	22	4	26	112	39
Khilchipur	388	1	294	27	74	40	32	48	3	14	10	69
Narsingharh	554	..	133	18	91	12	54	41	2	6	21	68
Rajgarh	535	4	119	20	80	21	75	44	3	8	45	46
<i>Malwa Agency.</i>												
Dewas States	494	..	132	16	118	17	61	56	3	11	28	64
Jaora	393	..	234	16	106	21	63	37	7	13	9	101
Ratlam	561	..	143	25	101	27	31	54	4	8	8	38
Sailana	455	..	96	38	233	30	22	46	4	9	13	54
Sitamau	609	..	108	29	75	8	16	47	..	26	10	72
<i>Southern Central India States Agency.</i>												
Ali-Rajpur	87	..	128	438	127	4	36	3	2	3	170	2
Barwani	186	..	61	8	682	5	44	6	1	2	..	5
Dhar	642	..	51	50	91	10	28	15	..	9	89	15
Jhabua	717	..	38	27	70	5	27	18	..	33	51	14
Jobat	575	..	94	109	140	10	10	..	5	5	52	..
East	552	3	204	21	111	10	6	27	1	23	33	9
<i>Bundelkhand Agency.</i>												
Ajaigarh	562	1	222	22	93	8	4	31	..	20	29	8
Baoni	741	..	113	16	53	16	11	10	2	12	20	6
Bijawar	616	..	175	13	99	9	2	21	2	16	43	4
Charkhari	619	..	180	6	54	12	1	25	2	24	72	5
Chhatarpur	533	..	177	37	174	5	4	28	2	29	6	5
Datia	635	..	136	10	122	33	5	28	..	15	4	12
Orchha	635	..	144	8	109	5	10	25	..	31	27	6
Panna	541	3	214	22	129	8	5	28	1	29	10	10
Samthar	701	..	98	11	84	56	3	26	1	11	6	3
<i>Baghelkhand Agency.</i>												
Baraundha	629	..	133	10	164	5	3	29	..	15	8	4
Kothi	632	..	173	32	125	4	7	21	..	1	4	1
Maihar	476	25	261	38	62	24	15	54	..	21	4	20
Nagod	492	..	165	29	91	5	17	32	2	11	145	11
Rewa	593	5	247	25	112	6	4	27	1	23	36	11
Sohawal	582	3	190	65	85	7	8	31	1	17	5	6

NOTE.—East includes Khaniadhana figures.

SUBSIDIARY TABLE III.

Occupation of females by Sub-Classes and selected Orders and Groups.

Group No.	Occupation.	No. of ACTUAL WORKERS.		No. of females per 1,000 males.
		Males.	Females.	
1	2	3	4	5
	Sub-class I.—Exploitation of Animals and Vegetation	1,611,343	956,552	591
	<i>1.—Pasture and Agriculture</i>	<i>1,607,461</i>	<i>956,120</i>	<i>590</i>
1	Non-cultivating proprietors taking rent in money or kind	12,102	1,980	164
5	Cultivating Owners	167,318	36,703	219
6	Tenant Cultivators	873,037	321,278	368
7	Agricultural labourers	430,089	570,558	1,326
13	Pan-Vine	2,701	978	362
16	Market gardeners, flower and fruit growers	5,839	2,348	402
18	Wood cutters and Charcoal burners	1,854	1,119	604
19	Collectors of forest produce	3,687	3,843	1,042
23	Herdsmen, Shepherds and breeders of other animals	93,907	15,217	162
26	Lac cultivation	678	802	1,183
	Sub-Class II.—Exploitation of Minerals	2,775	738	266
	Sub-Class III.—Industry	221,575	66,566	300
	<i>5.—Textiles</i>	<i>32,218</i>	<i>11,032</i>	<i>342</i>
42	Cotton ginning, cleaning and pressing	3,837	1,380	360
43	Cotton spinning, sizing and weaving	23,861	7,432	311
46	Wool carding, spinning and weaving	1,369	791	578
50	Lace, crepe, embroideries, fringes, etc., and insufficiently described textile industries.	63	95	1,508
	<i>6.—Hides, skins and hard materials, from the animal kingdom</i>	<i>4,851</i>	<i>1,177</i>	<i>243</i>
	<i>7.—Wood</i>	<i>33,792</i>	<i>13,164</i>	<i>390</i>
56	Basket makers and other industries of woody materials, including leaves and thatchers and builders working with bamboo, reeds or similar materials.	15,478	12,840	830
	<i>8.—Metals</i>	<i>15,385</i>	<i>1,636</i>	<i>106</i>
59	Blacksmiths, other workers in iron, makers of implements	12,231	1,183	97
	<i>9.—Ceramics</i>	<i>19,765</i>	<i>9,668</i>	<i>489</i>
	<i>10.—Chemical products properly so called and analogous</i>	<i>8,838</i>	<i>4,725</i>	<i>535</i>
68	Manufacture and refining of vegetable oils	7,894	4,416	559
	<i>11.—Food Industries</i>	<i>6,707</i>	<i>4,422</i>	<i>659</i>
71	Rice powders and huskers and flour grinders	459	2,857	6,224
72	Grain parchers, etc.	961	948	986
	<i>12.—Industries of dress and toilet</i>	<i>70,064</i>	<i>11,502</i>	<i>164</i>
82	Boot, shoes, sandal and clog makers	27,068	2,696	100
83	Tailors, milliners, dress makers and darners	13,018	2,939	226
85	Washing and cleaning	8,536	5,222	612
86	Barbers, hair dressers and wig makers	20,879	223	11
	<i>14.—Building Industries</i>	<i>8,996</i>	<i>3,009</i>	<i>334</i>
	<i>17.—Miscellaneous and undefined industries</i>	<i>19,913</i>	<i>6,131</i>	<i>308</i>
99	Other miscellaneous and undefined industries (toy making, taxidermy, etc.).	1,820	882	485
100	Scavenging	6,281	4,945	787
	Sub-Class IV.—Transport	24,198	2,426	100
	<i>20.—Transport by road</i>	<i>15,141</i>	<i>2,235</i>	<i>148</i>
106	Labourers employed on roads and bridges	3,176	1,824	574
	Sub-Class V.—Trade	95,302	37,015	388
	<i>27.—Trade in wood</i>	<i>1,043</i>	<i>388</i>	<i>372</i>
121	Trade in bamboos and canes	212	203	958
	<i>29.—Trade in pottery bricks, and tiles</i>	<i>561</i>	<i>940</i>	<i>1,676</i>
	<i>32.—Other trade in foodstuffs</i>	<i>49,783</i>	<i>26,400</i>	<i>530</i>
129	Grain and pulse dealers	17,180	3,338	194
130	Dealers in sweetmeats, sugar and spices	3,245	1,221	376
131	Dealers in dairy products, eggs and poultry	3,455	4,487	1,299
133	Dealers in fodder for animals	3,004	5,898	1,960
134	Dealers in other foodstuffs	20,834	11,097	533

SUBSIDIARY TABLE III—*concl'd.*Occupation of females by Sub-Classes and selected Orders and Groups—*concl'd.*

Group No.	Occupation.	NO. OF ACTUAL WORKERS.		No. of females per 1,000 males.
		Males.	Females.	
1	2	3	4	5
	37.—Trade in fuel	2,496	3,382	1,355
	38.—Trade in articles of luxury and those pertaining to letters and arts and sciences.	3,773	1,729	458
147	Dealers in common bangles, bead necklaces, fans, small articles, toys, hunting and fishing tackle, flowers, etc.	2,340	1,693	641
	39.—Trade of other sorts	10,778	1,564	145
150	General storekeepers and shopkeepers otherwise unspecified .	10,387	1,476	142
	Sub-Class VI.—Public force	33,594	73	2
	43.—Police	18,662	66	4
	Sub-Class VII.—Public Administration	40,020	1,324	33
	Sub-Class VIII.—Professions and liberal arts	28,085	4,731	161
	45.—Religion	12,580	813	65
	47.—Medicine	2,234	1,602	717
172	Midwives, Vaccinators, Compounders, Nurses, Masseurs, etc. .	1,043	1,383	1,326
	49.—Letters and arts and sciences (other than 44)	7,260	1,841	251
182	Musicians, Actors, Dancers, etc.	5,964	1,753	294
	Sub-Class IX.—Persons living on their income	3,904	1,364	349
	Sub-Class X.—Domestic service	37,580	17,197	458
	51.—Domestic service	37,580	17,197	458
187	Other domestic service	36,448	17,197	472
	Sub-Class XI.—Insufficiently described occupations	78,269	76,951	983
	52.—General terms which do not indicate a definite occupation . .	78,269	76,951	983
191	Labourers and workmen otherwise unspecified	70,358	76,407	1,086
	Sub-Class XII.—Unproductive	31,891	11,338	356
	54.—Beggars, Vagrants, Prostitutes	28,981	11,244	388
193	Beggars and Vagrants	28,975	10,854	345

SUBSIDIARY TABLE IV.

Variation in selected Occupations, 1921 to 1931 by Provinces.

Group No.	Occupation.	POPULATION SUPPORTED IN			Actual variation in 1921-1931.
		1931.		1921.	
		Earners (Principal Occupation) and working dependent.	Earners as subsidiary Occupation.	Actual workers.	
1	2	3	4	5	6
	Sub-Class I.—Exploitation of Animals and Vegetation	2,567,895	152,129	2,226,340	+341,555
	1.— <i>Pasture and Agriculture</i>	2,563,581	147,948	2,222,937	+340,644
	(a) Cultivation.				
1	Non-cultivating proprietors taking rent in money or kind	14,082	3,536	11,499	+2,583
2	Estate Agents and Managers of owners	186	14	1,564	-687
3	Estate Agents and Managers of Government	120	2		
4	Rent collectors, clerks, etc.	571	1,026		
5	Cultivating owners	204,021	7,354	1,435,540	-37,204
6	Tenant cultivators	1,194,315	53,702		
7	Agricultural labourers	1,000,647	52,169	669,177	+331,470
	(b) Growers of special crops, etc.				
13	Pan-Vine	3,679	327	12,743	-877
16	Market gardeners, flowers and fruit growers	8,187	3,941		
	(c) Forestry.				
18	Wood cutters and Charcoal burners	2,973	2,115	6,649	+3,854
19	Collectors of forest produce	7,530	4,253		
20	Collectors of lac	344	188		
	(d) Stock raising.				
21	Cattle and buffalo breeders and keepers	12,022	875	13,665	-1,643
23	Herdsmen, shepherds and breeders of other animals	109,124	8,590	67,661	+41,463
	(e) Raising of small animals and insects.				
26	Lac cultivation	1,480	9,482	..	+1,480
	2.— <i>Fishing and Hunting</i>	4,314	4,181	3,403	+911
	Sub-Class II.—Exploitation of Minerals	3,513	515	2,785	+728
	Sub-Class III.—Industry	288,141	46,272	328,250	-40,109
	5.— <i>Textiles</i>	43,250	5,972	50,081	-6,831
42	Cotton ginning, cleaning and pressing	5,217	863	6,129	-912
43	Cotton spinning, sizing and weaving	31,293	3,281	38,048	-6,755
46	Wool carding, spinning and weaving	2,160	1,313	2,961	-801
49	Dyeing, bleaching, printing, preparation and sponging of textiles	3,674	192	1,188	+2,486
	6.— <i>Hides, skins and hard materials from the animal kingdom</i>	6,028	1,315	11,243	-5,215
51	Working in leather	5,956	1,309	9,822	-3,866
	7.— <i>Wood</i>	46,956	6,852	49,552	-2,596
54	Sawyers	235	147	132	+103
55	Carpenters, turners and joiners, etc.	18,403	3,405	19,429	-1,026
56	Basket makers and other industries of woody materials including leaves and thatchers and builders working with bamboo reeds or similar materials.	28,318	3,300	29,991	-1,673
	8.— <i>Metals</i>	17,021	3,027	20,485	-3,464
59	Blacksmiths, other workers in iron, makers of implements	13,414	2,801	15,453	-2,039
60	Workers in brass, copper and bell metal	2,400	113	2,601	-201
	9.— <i>Ceramics</i>	29,433	3,624	32,062	-2,629
63	Potters and makers of earthen ware	26,808	3,241	28,590	-1,782
	10.— <i>Chemical products properly so called and analogous</i>	13,563	4,164	17,128	-3,557
68	Manufacture and refining of vegetable oils	12,310	4,011	16,138	-3,828
	11.— <i>Food Industries</i>	11,129	1,049	13,459	-2,330
71	Rice pounders and huskers and flour grinders	3,316	233	4,719	-1,403
72	Grain parcher, etc.	1,909	326	3,269	-1,360
73	Butchers	916	17	2,381	-1,465
75	Sweetmeat and condiment makers	3,735	241	2,432	+1,303

SUBSIDIARY TABLE IV.—*contd.*Variation in selected Occupations, 1921 to 1931 by Provinces—*contd.*

Group No.	Occupation.	POPULATION SUPPORTED IN			Actual variation in 1921-1931.
		1931.		1921.	
		Earners (Principal Occupation) and working dependent.	Earners as subsidiary Occupation.	Actual workers.	
1	2	3	4	5	6
	12.—Industries of dress and the toilet	81,566	16,479	92,959	-11,393
82	Boot, shoe, sandal and clog makers	29,764	7,951	34,176	-4,412
83	Tailors, milliners, dress makers and darners	15,957	1,573	16,339	-382
85	Washing and cleaning	13,758	2,171	19,365	-5,607
86	Barbers, hair-dressers and wig-makers	21,102	4,745	22,575	-1,473
	14.—Building Industries	12,005	1,493	12,424	-419
	17.—Miscellaneous and undefined Industries	26,044	2,252	28,619	-2,575
98	Makers of jewellery and ornaments	11,576	1,037	12,077	-501
99	Other miscellaneous and undefined industries (toy making taxidermy, etc.)	2,702	562	87	+2,615
100	Scavenging	11,226	578	12,284	-1,058
	Sub-Class IV.—Transport	26,624	9,844	17,977	+8,647
	19.—Transport by water	489	221	310	+179
	20.—Transport by road	17,376	9,387	19,273	+7,103
106	Labourers employed on roads and bridges	5,000	722	4,097	+3
107	Owners, managers and employees (excluding personal servants) connected with mechanically driven vehicles (including trams).	420	46	45	+375
108	Owners, managers and employees (excluding personal servants) connected with other vehicles.	8,481	7,668	3,312	+5,169
110	Pack elephant, camel, mule, ass and bullock, owners and drivers	1,549	803	1,865	-316
111	Porters and messengers	1,545	61	691	+854
	21.—Transport by rail	7,596	184	6,593	+1,003
112	Railway employees of all kinds other than coolies	4,060	81	5,397	-1,337
113	Labourers employed on railway construction and maintenance and coolies and porters employed on railway premises.	3,536	103	1,196	+2,340
	22.—Post Office, Telegraph and Telephone services	1,163	52	801	+362
	Sub-Class V.—Trade	132,317	35,601	153,132	-20,815
	23.—Banks, establishments of credit, exchange and insurance	7,663	6,789	8,096	-433
	24.—Brokerage, commission and export	1,491	258	2,426	-935
	25.—Trade in textiles	7,898	1,040	8,060	-162
	26.—Trade in skins, leather and furs	697	163	529	+168
	27.—Trade in wool	1,431	480	495	+936
	28.—Trade in metals	651	69	490	+161
	29.—Trade in pottery, bricks and tiles	1,501	116	57	+1,444
	30.—Trade in chemical products	1,783	615	2,115	-332
	31.—Hotels, cafes, restaurants, etc.	3,155	513	3,872	-717
126	Vendors of wine, liquors, aerated waters and ice	1,892	444	3,695	-1,803
	32.—Other trade in foodstuffs	76,183	20,119	96,538	-20,355
129	Grain and pulse dealers	20,518	3,060	21,710	-1,192
130	Dealers in sweetmeats, sugar and spices	4,466	580	1,448	+3,018
131	Dealer in dairy products, eggs and poultry	7,942	2,747	13,025	-5,083
133	Dealer in fodder for animals	8,902	6,814	13,067	-4,165
134	Dealer in other foodstuffs	31,931	6,327	44,550	-12,619
	33.—Trade in clothing and toilet articles	3,619	326	608	+3,011
	34.—Trade in furniture	624	70	189	+435
	35.—Trade in building materials	516	43	242	+301
	36.—Trade in means of transport	1,353	476	5,046	-3,693
	37.—Trade in fuel	5,878	2,862	6,790	-912
	38.—Trade in articles of luxury and those pertaining to letters and arts and sciences.	5,502	450	4,668	+834
147	Dealers in common bangles, beads, necklaces, fans, small articles, toys, hunting and fishing tackle, flowers, etc.	4,333	366	3,519	+814
	39.—Trade in other sorts	12,342	1,182	12,911	-569
150	General storekeepers and shopkeepers otherwise unspecified	11,863	1,158	8,436	+3,427

SUBSIDIARY TABLE IV—concl'd.

Variation in selected Occupations, 1921 to 1931 by Provinces—concl'd.

Group No.	Occupation.	POPULATION SUPPORTED IN			Actual variation in 1921-1931.
		1931.		1921.	
		Earners (Principal Occupation) and working dependent.	Earners as subsidiary Occupation.	Actual workers.	
1	2	3	4	5	6
	Sub-Class VI.—Public force	33,667	3,190	40,250	-6,583
	40.—Army	14,939	387	20,440	-5,501
153	Army (Imperial)	2,449	3	4,713	-2,264
154	Army (Indian States)	12,490	384	15,727	-3,237
	43.—Police	18,728	2,803	19,810	-1,082
158	Village watchmen	7,012	2,406	10,356	-3,344
	Sub-Class VII.—Public Administration	41,344	6,630	50,436	-9,092
	44.—Public Administration	41,344	6,630	50,436	-9,092
159	Service of the State	1,047	11	1,735	-688
160	Service of Indian and foreign States	29,538	1,305	36,183	-6,645
162	Village Officials and servants other than watchmen	9,124	5,238	7,368	+1,756
	Sub-Class VIII.—Professions and liberal arts	32,816	8,122	33,854	-1,038
	45.—Religion	13,393	5,031	17,266	-3,873
163	Priests, Ministers, etc.	8,670	3,652	7,591	+1,079
164	Monks, nuns, religious mendicants	974	271	858	+110
166	Servants in religious edifices, burial and burning grounds, pilgrim conductors, circumcisers, etc.	3,111	1,015	8,266	-5,155
	46.—Law	1,124	77	845	+279
	47.—Medicine	3,836	499	2,869	+967
169	Registered medical practitioners including oculists	494	15	1,030	+380
170	Other persons practising the healing arts without being registered.	792	298		
171	Dentists	12	1		
173	Veterinary Surgeons	112	14		
172	Midwives, Vaccinators, Compounders, Nurses, Masseurs, etc.	2,426	171	1,839	+587
	48.—Instruction	5,359	274	3,358	+2,001
	49.—Letters and arts and sciences (other than 44)	9,104	2,241	9,516	-412
178	Authors, Editors, Journalists and Photographers	105	18	562	-457
182	Musicians (Composers and performers other than military), actors, dancers, etc.	7,717	2,070	6,989	+728
	Sub-Class IX.—Persons living on their income	5,268	463	5,458	-190
	Sub-Class X.—Domestic service	54,777	5,590	61,701	-6,924
	51.—Domestic service	51,777	5,590	61,701	-6,924
187	Other domestic service	53,645	5,556	61,342	-7,697
	Sub-Class XI.—Insufficiently described occupations	155,220	15,432	277,515	-122,295
	52.—General terms which do not indicate a definite occupation	155,220	15,432	277,515	-122,295
189	Cashiers, Accountants, book-keepers, clerks and other employees in unspecified offices, and warehouses and shops.	6,371	430	4,679	+1,692
191	Labourers and workmen otherwise unspecified	146,765	14,776	270,732	-123,967
	Sub-Class XII.—Unproductive	43,229	6,500	63,529	-20,300
	53.—Inmates of Jails, asylums and alms houses	2,875	..	3,120	-245
	54.—Beggars, vagrants, prostitutes	40,225	6,471	59,701	-19,476

SUBSIDIARY TABLE VI.

Number of persons employed on Railways, Post and Telegraphs and Irrigation.

(a) Railways.

Class of persons employed.	Europeans and Anglo-Indians.	Indians.	REMARKS.
1	2	3	4
Total persons employed	160	12,124	
Officers	12	5	
Subordinates on scales of pay rising to Rs. 250 per mensem or over	70	44	
Subordinates on scales of pay rising from Rs. 30 to Rs. 249 per mensem	76	1,812	
Subordinates on scales of pay under Rs. 30 per mensem	2	10,263	

(b) Post and Telegraphs.

Class of persons.	POST OFFICE.		TELEGRAPH DEPARTMENT.		REMARKS.
	Europeans and Anglo-Indians.	Indians.	Europeans and Anglo-Indians.	Indians.	
1	2	3	4	5	6
Total persons employed	1	1,403	23	137	
(1) <i>Post and Telegraphs.</i>	1	1,046	23	137	
Supervising officers (including probationary superintendents and Inspectors of Post offices and Assistant and Deputy Superintendents of Telegraphs and all officers of higher rank than these).	..	5	9	1	
Post masters including Deputy, Assistant, Sub and Branch Post masters.	1	124	
Signalling establishment including warrant officers, non-commissioned officers, military telegraphists and other employées.	..	1	12	11	
Miscellaneous agents, School masters, Station masters, etc.	..	210	2	23	
Clerks of all kinds	..	70	
Postmen	..	298	
Skilled labour establishment including foremen, instrument makers, carpenters, blacksmiths, mechanics, sub-Inspectors, linemen and lineriders and other employées.	..	3	..	75	
Unskilled labour establishment including line coolies, cable guards, battery men, telegraph messengers, peons and other employées.	..	91	..	27	
Road establishment consisting of Overseers, runners, clerks and booking agents, boatmen, Syces, coachmen, bearers and others.	..	244	
(2) <i>Railway Mail Service.</i>	..	188	
Supervising officers (including Superintendents and Inspectors of Sorting).	..	3	
Clerks of all kinds	..	6	
Sorters	..	107	
Mailguards, mail agents, van peons, porters, etc.	..	72	
(3) <i>Combined Offices.</i>	..	169	
Signallers	..	95	
Messengers and other servants	..	74	

(c) Irrigation.

Class of persons.	Europeans and Anglo-Indians.	Indians.	REMARKS.
1	2	3	4
Total persons employed	..	336	
1. Persons directly employed	..	141	
Officers	..	2	
Upper Subordinates	
Lower Subordinates	..	6	
Clerks	..	11	
Peons and other servants	..	91	
Coolies	..	31	
2. Persons indirectly employed	..	195	
Contractors	..	20	
Contractors regular employées	..	8	
Coolies	..	167	

CHAPTER IX.

Literacy.

154. **The basis of the figures.**—Prior to 1921 Census, the heading of this chapter was Education. In 1881 and 1891, the population was divided in respect of education into three categories—Learning, Literate and Illiterate. It was found, however, that the return of the ‘learning’ was vitiated by the omission at one end, of children, who had not long been at school and at the other of the more advanced students who were classed as ‘Literates’. There were thus great discrepancies between the Census returns of the number of ‘Learning’ and the corresponding statistics of the Education Department. In 1901 Census, ‘learning’ was consequently abandoned and the instructions were to enter all persons who could read and write any language. Since 1911 the practice has been to impose a small test which is ability both to read and write a letter. The instructions on the Cover ran :—

Column 16 (Literate or Illiterate).—Enter against all persons who can read and write any language other than English, names of languages. For those who can read and write English alone enter the word “Literate”. In the case of persons who cannot read and write any language make a X.

Column 17 (English).—Enter the word “Yes” against all persons shown as literate who can both read and write English as well as speak it. Otherwise put a X.

No other instructions were issued. As far as this Agency is concerned the change in practice in 1901 does not affect our figures. The British India schedule was not applied fully to the Indian States of this Agency in 1881 and 1891. The information regarding education was at these two Censuses collected only for the Cantonments, the administered areas and the railway lands. Again owing to the excision of Gwalior in 1921 comparative figures for 1901 and 1911 are not available. In discussing variations in and progress of, literacy in this chapter our analysis will be mainly confined to the intercensal decade.

The figures in Imperial Table XIII are exhibited in three columns. One shows general literacy without reference to any particular language, the second shows general illiteracy and the third literacy in English language. Though there was no demand from any State, literacy by languages, was recorded in this Census. The main statistics for this have been exhibited as an appendix to Imperial Table XIII.

155. **Accuracy of the figures.**—The standard of Census literacy is a modest one and it is not likely the enumerator has gone wrong in securing correct returns. There may be stray instances where a person who can scribble a little or smatter few words of English might have passed himself as literate. Such cases are likely to occur in a city like Indore where often the enumerator is not conversant with the people with whom he is dealing. An urban dweller also realises the social value attached to literacy and some may have described themselves as literate even though they strictly were not. The instructions to the enumerators were precise and there is no reason to doubt that they did not exercise every care. In many villages the only literate man is the enumerator. He knows his village *intelligentsia*. Nobody can advance a spurious claim before him for he knows where to place his false rival. Our figures for literacy therefore may be accepted as accurate.

156. **General remarks : Outlook and attitude towards education.**—The Census figures for literacy are perhaps more sought after than any other Census statistics. They are invested with some significance in a country like India where the general mass of the population is illiterate. Central India is one of the tracts where according to Census statistics illiteracy is prevalent to a high degree. Before the regional figures are analysed, it may not be out of place if certain general considerations are mentioned which have a bearing on and which condition to a great extent, the statistics of literacy. They are, the tradition of literacy by community or communities, the presence of an educated class, the

attitude of the mass of people towards education and the will to learn, and lastly the part played by the State in the spread of education.

In India, from the early times, learning has always remained concentrated in few communities. But there has always been mass literacy of certain kind. In the villages some rudiments of learning have always been kept up and a flickering feeble light has always been burning through ages. It has not been intense enough to create a tradition or a desire to acquire literacy or to create a consciousness that light at any cost is preferable to darkness. The Rajput, as a ruling class disdained and disliked learning. It was unbecoming of the wielder of the sword to grind at books. Though high in the social scale, the Rajput is not 'advanced' as a community in literacy. At the same time it should not be supposed that the Rajput was against all learning. The Rajput Chiefs have been patrons of the learned and to some of them we owe the development of Hindi languages. In the Rajput polity there was no need for any literate class. The Bhats and the Charans, replete with the bardic lore, the genealogy and the exploits of the clans, adequately fulfilled the functions and the feudal character of the administration did not demand many literate functionaries. It is only when the foreign rulers came—Muslims and the Marathas—that there was a need for a functionary class to carry on the administration. The former imported the Kayasthas and the latter brought with them the literate communities who were playing no insignificant part in the growth of the Maratha rule in the Deccan. Political causes thus caused an influx of classes with a tradition for literacy. In the early days they constituted mere colonies planted owing to the needs of the administration. They had neither the root in nor did they grow out of the native soil and they had little contact with the indigenous mass. As we have already seen in Chapter I the villages in Central India were living organisms. They kept up some pretence to literacy unaided by any outside authority. A century ago when these parts were settling down to a peaceful life after a period of strife and anarchy, it was noticed that a large number of private schools were maintained in the country side. We gather that every village over 100 houses had a school master who taught the children of the traders and of such cultivators as chose to receive education. The cultivators whenever they afforded it were not averse to educate their children. The school master's office was hereditary from generation to generation. He was held in high esteem and there was often an annual festival celebrated in this honour. Literacy was not the monopoly of the Brahman community. In fact one in a hundred amongst them could perhaps read. The village priest and the small community of Jains (the trading as well as the Jati or the priestly section) played a considerable rôle in the diffusion of literacy. The learning imparted was no doubt rudimentary and limited. The chiefs had to import their functionaries from outside.¹

Later on with the disintegration of the village communal life, the relapse into illiteracy was more marked than in the previous periods. At all periods the vast majority were never within the pale of learning. Those that were joined the ranks of those who were without. It was therefore no exaggeration when only 40 years ago it was stated that in matters of general education in Central India the darkness was Cimmerian.

When the unaided voluntary effort of the villages completely broke down it took a long time in these parts before the State stepped in to discharge its obligations towards educating the people. Progress was rapid where the direct contact of British rule was felt; it was necessarily slow where the influence was indirect. With his profound ignorance of Oriental culture, when Macaulay wrote that the question was whether—

“ we shall countenance at the public expense, medical doctrines which would disgrace an English farrier, astronomy which would move laughter in girls at an English boarding school, history abounding in kings thirty feet high and reigns thirty thousand years long and geography made of seas of treacle and seas of butter.”²

the rulers of States were in no haste to embark upon educational expansion on modern lines. But a beginning could not be postponed and neither progress arrested. A College was opened for the education of the chiefs themselves and thus influence was exercised in the spread of education directly by the States.

¹ *Memoir*, ii, 191-192.

² Quoted in the *Indian Empire*, Volume iv, 411.

Our figures are therefore an index of progress achieved in the last few decades only. That progress is uneven and is dependent upon the acceptance of the modern idea of State education by the Ruler of a State. It is further dependent upon the financial resources of the many diverse principalities. Finally there is a vast body of illiterate population, a component part of which for generations has never known what learning is, another which could never be induced to learn except it be by compulsion and the rest, with the exception of a small minority, is indifferent towards education. These general factors should be borne in mind in considering the statistical aspects of literacy in Central India.

157. Statistical reference.—The information regarding literacy is embodied in Imperial Tables XIII and XIV. In Table XIII the number of literate and illiterate persons are shown by sex and religion classified under the age periods 0-5, 5-10, 10-15, 15-20 and 20 and over and in Table XIV their distribution by caste. In both the tables the figures for English literacy are also given. The following Subsidiary Tables will be found at the end of the Chapter—

- I—Literacy by Age, Sex and Religion.
- II—Literacy by Age, Sex and Locality.
- III—Literacy by Religion, Sex and Locality.
- IV—English literacy by Age, Sex and Locality.
- V—Literacy by Caste, 1931 and 1921. (Table V of 1921.)
- VI—Progress of Literacy since 1881. (Table V of 1921.)
- VII—Proportion of Literacy at certain ages.
- VIII—Number of Institutions and pupils according to the returns of the Education Department.

In the presentation of general literacy figures in Table XIII and the proportional figures based on that table, it is assumed as in 1921 that the population below 5 is illiterate and the age group 0-5 has been excluded in working out the ratios of the literates in the population. Ordinarily the same procedure should have been applied to the presentation of literacy figures for castes in Table XIV. This, however, would have involved a quantity of calculation which was hardly justified. The age group 4 to 6 required to be split up and moreover Table VIII was compiled on unadjusted ages. It was therefore decided that in Table XIV the population should be shown as 7 years and over and the literates in English as 7 years and over. In Subsidiary Table V to this Chapter the ratio of literates in each caste is first calculated on the population of that caste, 7 years and over. The proportion of literates to the total strength of that caste is also shown below it. It should be pointed out that the figures in columns 2 to 10 in Subsidiary Table V are not comparable with the corresponding columns in 11 to 19 for the population dealt with this time is 7 years and over whereas in 1921 it was 5 years and over. This is a source of unavoidable disparity for comparative purposes.

158. Extent of literacy.—In this Census 268,545 males and 25,572 females

Literacy in British Indian Provinces.

Provinces.	LITERATE PER MILLE AGED 5 AND OVER.			
	Males.		Females.	
	1931.	1921.	1931.	1921.
I	2	3	4	5
Bengal	180	181	32	21
Bombay	167	157	29	27
Central Provinces	110	87	11	9
United Provinces	94	73	11	7
Punjab	95	74	15	9
Bihar and Orissa	95	96	8	6
Madras	188	173	30	24
Central India Agency	92	64	9	6

over the age of 5 have returned themselves as literate. The total population excluding those in the age period 0-5, is 5,633,090 (2,917,439 males and 2,715,651 females). This means according to the Census test of literacy 52 persons per mille are literate in Central India. The enormous disparity in sex proportions is emphasised when we see that 92 males per mille are literate while only 9 females per mille are literate. For every one literate female there are 10 literate males.

In Subsidiary Table I proportional figures are given by age and sex. In the period 15-20, are found the highest proportions of literates, viz., 112 males per mille and 14 females per mille. In the preceding age group 5-10, which represents approximately the population receiving primary education there are 61 males literate per mille and only 10 females literate per mille. The number of male literates per mille in the major Provinces of India is shown for purposes of comparison.

To compare the figures for Central India with those of the Provinces is apt

Literacy in selected major Indian States.

State.	LITERATE PER MILLE AGED 5 AND OVER.			
	Males.		Females.	
	1931.	1921.	1931.	1921.
	2	3	4	5
Baroda	331	240	79	47
Cochin	460	274	220	99
Gwalior	78	61	11	7
Hyderabad	83	57	10	8
Jodhpur	80	74	6	5
Jaipur	71	71	5	4
Mewar	65	54	3	3
Bikaner	85	73	9	6
Mysore	174	143	33	22
Bhopal	62	43	7	3
Indore	157	103	23	14
Rewa	64	36	4	2

to be misleading as the former is not an administrative unit and a group of Indian States cannot be set off against vast Indian Provinces. Therefore in the marginal table, proportions are given for some of the principal States in India. Indore, Bhopal and Rewa which together make up half the area and population of the Agency are shown below. The table brings out the great unevenness of progress in literacy made by the States scattered in all parts of the Indian Empire.

159. **Variation of literacy according to locality.**—In Subsidiary Table II will be found the variation of literacy according to the natural divisions and by the principal States. The proportions in the two natural divisions are extracted in the marginal table and the same are shown in the diagram. The West with its towns and large urban centres maintains the lead over the East. During the decade there has been a steady increase in both the divisions. The East is still very far behind in the female education and it has not yet

Variation of literacy in the Natural Divisions.

Natural Division.	LITERATE PER MILLE AGED 5 AND OVER.			
	Males.		Females.	
	1931.	1921.	1931.	1921.
	2	3	4	5
West	113	85	15	10
East	68	42	4	2

reached the stage of showing 1 female per 100 as literate. In the East again, among both the sexes, the proportions are below those for the whole Agency.

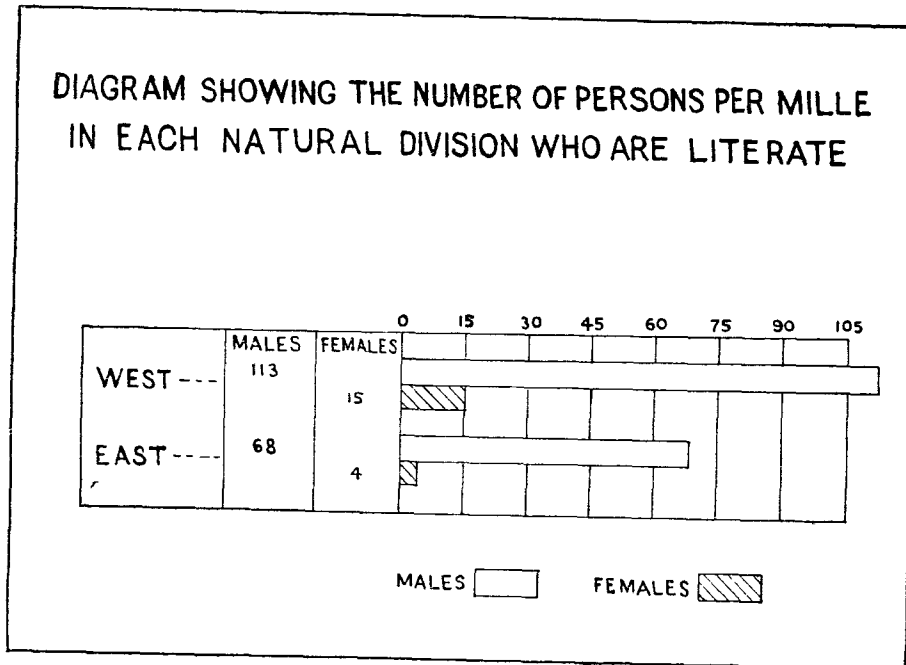

reached the stage of showing 1 female per 100 as literate. In the East again, among both the sexes, the proportions are below those for the whole Agency.

The enormous leeway the different States in Central India have to make up in the progress of literacy is seen in the subjoined table and the map illustrates the number of males per mille who are literate.

Literacy by age-periods in the Principal States.

States.	NUMBER PER MILLE WHO ARE LITERATE.										
	ALL AGES 5 AND OVER.			5-10.		10-15.		15-20.		20 AND OVER.	
	Persons.	Males.	Females.	Males.	Females.	Males.	Females.	Males.	Females.	Males.	Females.
1	2	3	4	5	6	7	8	9	10	11	12
Ratlam	104	174	28	54	13	102	27	195	43	217	30
Sitamau	96	167	20	65	15	117	22	189	25	199	20
Indore	93	157	23	73	21	114	27	193	31	178	20
Sailana	78	137	15	51	12	95	16	158	21	169	15
Dhar	74	134	12	49	7	92	12	180	17	158	12
Dewas	76	133	15	60	10	101	19	169	23	154	14
Datia	59	109	3	35	1	68	3	135	4	131	4
Nagod	55	104	6	36	6	79	9	144	7	120	5
Jaora	53	93	9	29	5	55	8	111	14	116	9
Narsingharh	51	89	8	34	6	62	10	105	10	105	7
Chhatarpur	49	88	7	28	5	53	9	102	12	108	7
Barwani	44	83	4	25	2	49	3	103	6	109	5
Baoni	47	83	7	22	2	44	5	98	10	105	8
Samthar	45	83	4	21	2	41	3	86	3	106	4
Rajgarh	43	74	7	32	4	52	7	86	9	87	6
Maihar	41	71	12	29	4	102	12	159	18	57	13
Charkhari	37	68	4	17	1	34	4	70	6	88	4
Panna	36	67	3	24	2	44	4	78	5	83	4
Rewa	34	64	4	22	2	42	3	75	5	79	4
Bhopal	36	62	7	23	5	37	8	70	10	77	7
Orchha	31	58	2	15	1	31	..	68	3	74	2
Ajaigarh	29	53	3	10	2	24	3	53	5	70	4
Khilchipur	28	50	4	15	3	30	4	62	4	60	4
Jhabua	28	47	8	16	6	28	10	62	12	62	8
Bijawar †.	24	45	2	12	..	29	1	52	3	56	2
Ali-Rajpur	17	29	4	7	2	15	4	39	6	40	4

The States are arranged in the table according to the proportion of male literates per mille in column 3. This arrangement serves as a key to the variations by States shown in the map. The literacy zone in Central India lies in the western

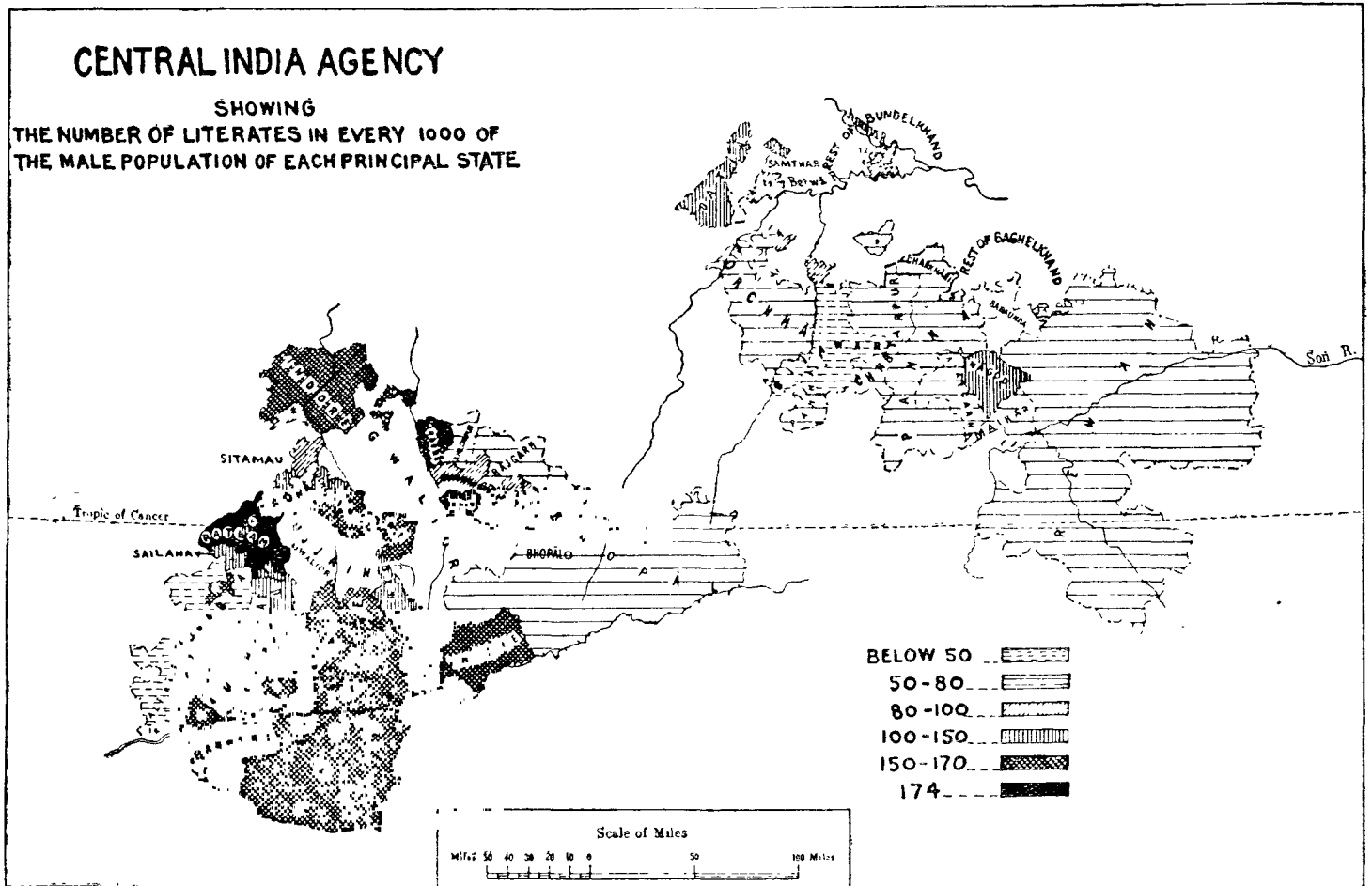

and central Malwa States. These possess urban population, certain progressive communities who take to education and the literate trading classes who contribute towards literacy figures. In the State of Indore, there has been a forward educational policy for a long time. In northern Malwa, literacy in the Bhopal Agency States is low and Bhopal has only 36 literate persons per mille. The lowest proportions are in the hilly tracts—Jhabua (28) and Ali-Rajpur (17) which contain a large Bhil population. Barwani is more progressive though it lies in this region. That is partly because a portion of the State lies in the Narbada valley, and has a number of towns. In the interior of Bundelkhand, literacy is low in the important States of Orchha (31) and Panna (36). Rewa in Baghelkhand has only 34 literates per mille. These are still backward areas.

The proportion of literacy in the different age periods may now be noticed. In the whole of Central India there are 92 males per mille who are literate in all ages 5 and over. The proportion is 61 per mille in the period 10-15, 112 in the period 15-20 and in 20 and over it is 111 per mille. It is usually held that the age group 15-20, shows the extent of literacy as those who have acquired the faculty to read and write will have done so before they are twenty. The drop in proportion in the later age period should be normally looked for. In this Census there is a slight drop in the period 20 and over but this was not the experience in the last Census when there was a slight rise. The regional figures show variation again when we consider columns 9 and 11 in the table. In 17 places column 11 shows an increase over column 9 while in 7 places it shows a decrease. This is incongruous and appears to be seemingly contradictory. The reason is that our figures for literacy include those who are receiving education in the Schools and those who acquire literacy outside the educational institutions. The trading classes who contribute considerably to the literacy figures, acquire the rudiments at a later period and according to their inclination. Where the tradition to learn is strong and education is the only means to a livelihood in life, schooling begins early and the acquisition of literacy is a matter of utmost importance and respon-

sibility. The paucity of educational facilities and the absence of any compulsion, do not compel the children to go to school as soon as they have completed a certain age. The matter is one of choice to many and necessity only to a few. It is not uncommon for a Bania boy to learn enough to carry on his business when he feels he should take a hand in the family business. In some cases literacy of a very rudimentary nature is first acquired, then there is a lapse from it for few years and is reacquired at a later age more especially in urban surroundings. Generally in the rural parts there is no incentive to acquire literacy at the later ages or to reacquire it after a period of lapse.

160. **Literacy by Religion and Age.**—The proportions of literacy vary amongst the various religious communities as will be seen from the diagram.

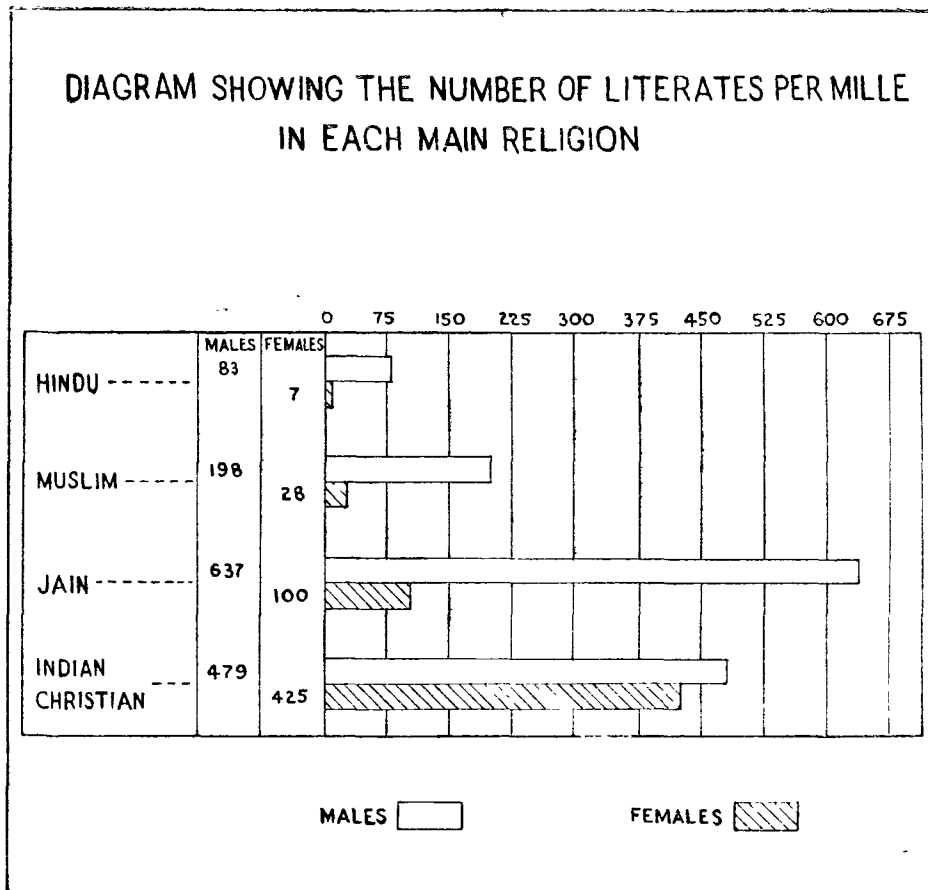

The marginal table gives the figures extracted from Subsidiary Tables I and III

Literacy in the main Religions.

Religion.	LITERACY PER MILLE BY RELIGION (AGED 5 AND OVER).			LITERACY PER MILLE AGED 15-20.	
	LITERATE.			LITERATE.	
	Total.	Males.	Fe-males.	Males.	Fe-males.
1	2	3	4	5	6
All Religions . . .	52	92	9	112	14
Christian . . .	613	672	530	787	622
Indian Christian	453	479	425	639	577
Other Christian	945	965	896	977	851
Jain . . .	387	637	100	723	154
Muslim . . .	119	198	28	239	43
Hindu . . .	46	83	7	102	10
Tribal . . .	1	2	..	2	..

for ready reference. The high figures for the Christians need no explanation. The other Christian figures are of the European colony. The Indian Christian community is small and receives the benefit of education in the cities and in the areas covered by the Christian missions. The Jains take the lead in the matter of literacy amongst the followers of the remaining religions. Literacy in their case is a useful and necessary auxiliary in their trade and profession. Their women show greater inclination to learn than those of other com-

munities. The Muslims who come next have one-third of the Jain proportion but they are far ahead of the Hindus. This is clearly seen in the proportion of literates in the age periods 15-20 in both the communities. The traders amongst

the Muslims, the Bohras, who are found chiefly in Malwa, are usually literate. As we have already seen in Chapter II, the Muslims are found concentrated in urban areas where they have greater opportunity to learn. They also seek employment in State services and in the Muslim States a large number of them find employment in the services. The better class of Muslims, Sayyids and Pathans, have always possessed a tradition for literacy. But for the presence of the typically illiterate section amongst them like Jolaha, Pinjara and other functional groups, the proportion of literacy amongst Muslims would have been higher still. Though a vast and predominating community, the Hindu proportions need cause no surprise. It will be seen further on in Chapter XI how heterogeneous is the Hindu composition. It consists of small classes who are highly literate, to whom learning is a hereditary instinct and whose mental faculties are highly developed. It also embraces in its fold the so-called Hinduised aboriginies, the depressed classes and a host of other castes many of whom even do not know that there is such a thing like an alphabet, a common article in human culture. The Tribal figures require no comment. They are eloquent in themselves and are a powerful reminder to the more advanced that no genuine progress is possible when there are communities who have yet not seen light and are groping in a region of utter darkness.

161. Literacy by Caste.—In Imperial Table XIV statistics for a number of representative castes have been shown and Subsidiary Table V exhibits the proportional figures for them. At one time it was intended for literacy purposes to divide the castes into Advanced, Intermediate and Backward. Such a list is useful from the educational point of view but a list for the Agency is of doubtful value. This scheme of classification was, however, abandoned during the abstraction stage. In this Agency without attempting a meticulous classification into advanced, intermediate and backward based on any percentage criteria, the castes selected for Table XIV have been so arranged as broadly to fall into the 3 above mentioned classes and included in the backward castes are the depressed classes, criminal tribes, primitive tribes and other backward castes. Barring few Muslim groups and Rajput septs, there are practically no classes which could find a place in the intermediate category. At the top in the advanced class will have to be placed a few sub-castes of Brahmans and Baniyas and the Kayasthas. The rest of the population is fittingly accommodated in the backward category. The diffusion of literacy in the different strata of the society is brought out in the diagrams opposite. It confirms once again the impression that literacy is prevalent in the professional and trading classes; it has made little headway in the vast mass of the agricultural and rural population and has barely touched the lowest in the stratum. The primitive tribes are entirely outside the range of it. Not a single Tribal Baiga has been returned as literate and it will take some generations before he contributes his quota to our literacy table. He has his own tribal conceit for not even cultivating the land for such unworthy occupation befits the Gond more. He would rather practise the shifting cultivation and be the master of the jungle, hunting and tracking a tiger than put his hand to the plough and least of all sit in a school and learn those mysterious symbols which no one in his tribe has done before. On the other hand no one can repress the inherent desire of a Brahman boy to learn as soon as he can lisp his numbers. The desire and the will to learn is partly an accident in birth and is partly influenced by the occupation in life. To many communities it is nothing unusual if literacy follows certain occupation or if it is the monopoly of few. For the present, it is only the manipulator of Census statistics who is struck aghast at the wide gap and the deep chasm which his figures reveal. The uneven nature of the progress is seen when we analyse the figures by different classes and their sub-classes. The number of Brahman male literates per mille is 265. If we consider the sub-castes in the

Literacy in certain Brahman sub-castes.

Sub-caste of Brahman.	Literate males per mille aged 7 and over.
1	2
Dakshani	884
Shrimali	756
Sarwaria	198

margin, we at once notice the enormous variation. The Dakshani Brahmans are a foreign immigrant community found mostly in the Maratha States. The Shrimalis take up service in large numbers as petty revenue officials. The Sarwarias who are found mainly in Rewa and in eastern parts of the Agency are mostly engaged in cultivation and this is at once seen in the low proportion of literacy among them. Among

LITERACY AMONGST MALES IN SELECTED CASTES

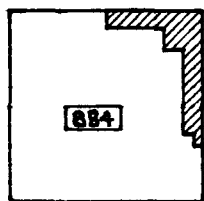

BRAHMIN DAKSHANI

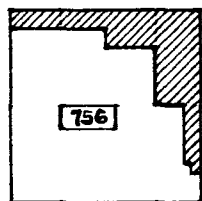

BRAHMIN SHRIMALI

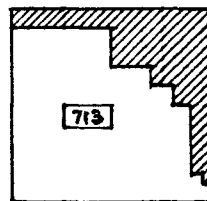

BANIA MAHESRI

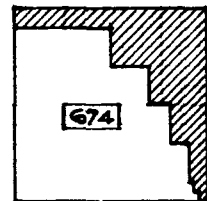

KAYASTH

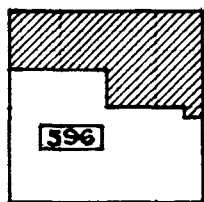

BANIA OSWAL

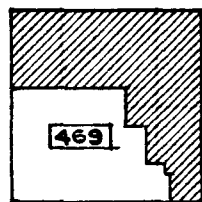

BANIA GAHOHI

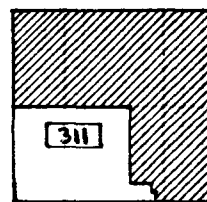

RAJPUT BAGHELA

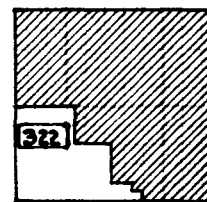

PATHAN

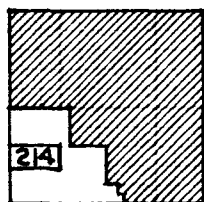

SHEIKH

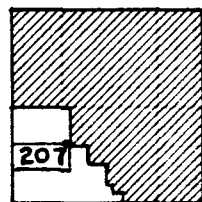

RAJPUT PARIHAR

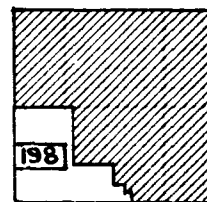

BRAHMIN SARWARIA

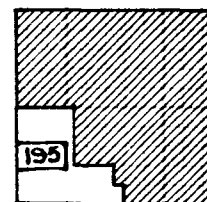

RAJPUT BUNDELA

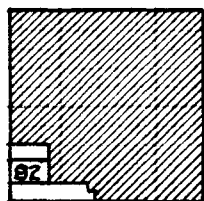

JAT



JULAHA

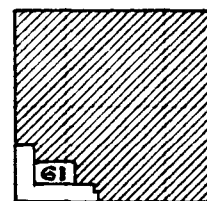

MALI

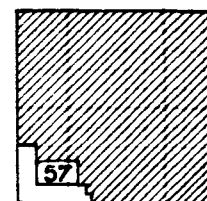

NAI

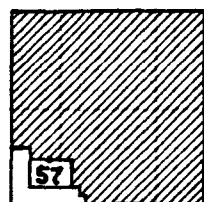

TELI

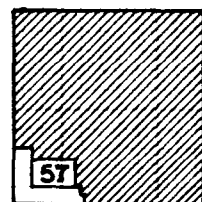

KURMI

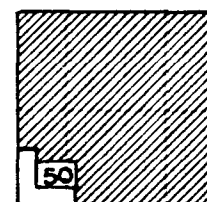

GUJAR

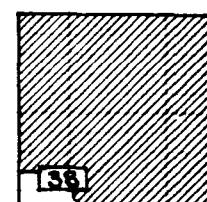

BEHNA

(CONTINUED ON NEXT PLATE)
 NOTE:- LARGE SQUARE = 1000 MALES.
 SMALL SQUARE = 10 MALES.
 NUMBER LITERATE PER THOUSAND MALES SHOWN THUS **38**

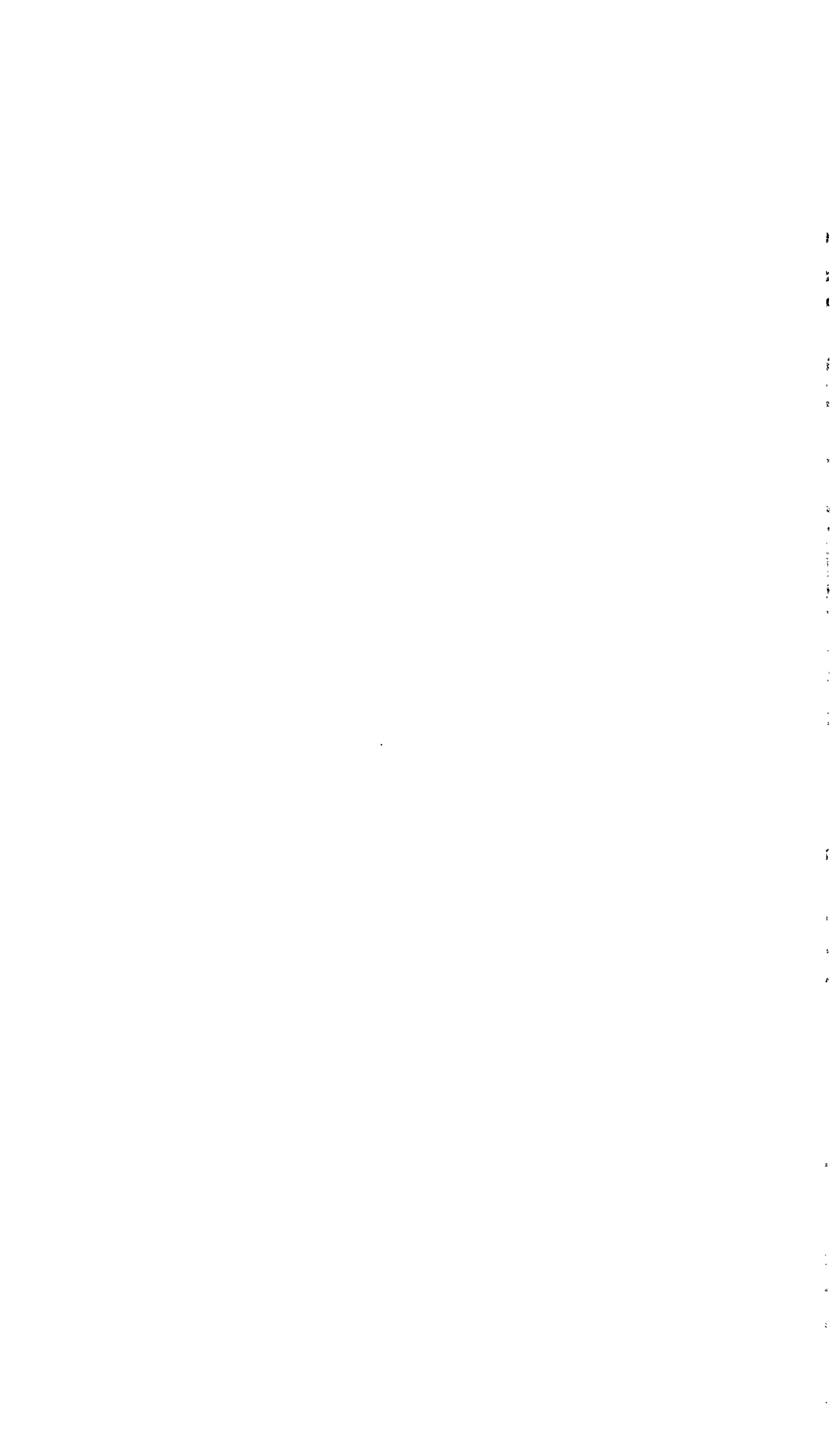

LITERACY AMONGST MALES IN SELECTED CASTES

(CONTINUED FROM PREVIOUS PLATE)

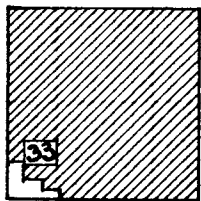

RAJPUT GAHLOT

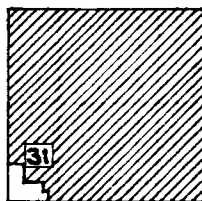

LODHI

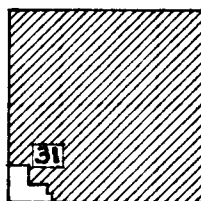

MEHTAR

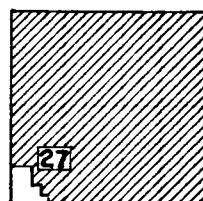

AHIR

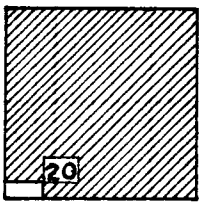

KOLI

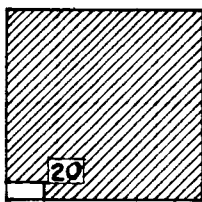

DHOBI

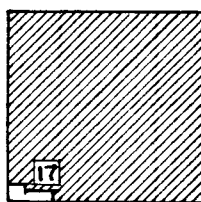

SONDHIA

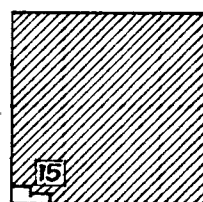

MOGHIA

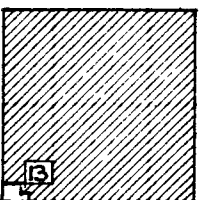

BALAI

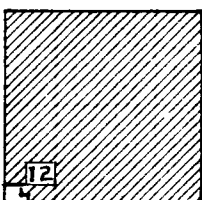

GADARIA

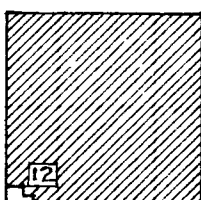

BANJARA

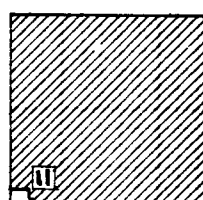

KOTWAL

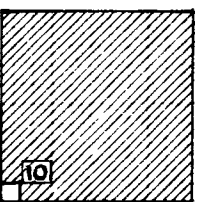

KACHHI

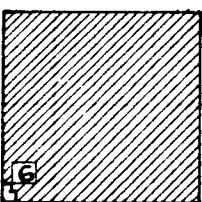

GOND

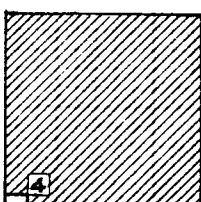

CHAMAR

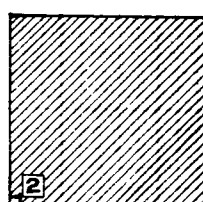

BANSPHOR

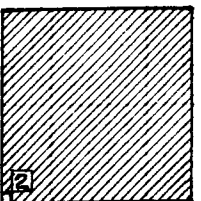

BHIL

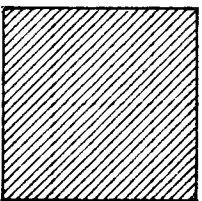

SOR

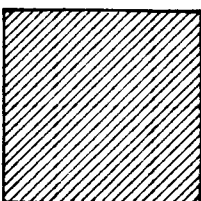

BAIGA

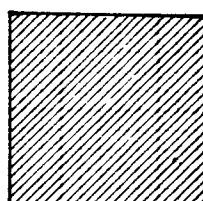

KOL

NOTE :- LARGE SQUARE = 1000 MALES .

SMALL SQUARE = 10 MALES .

NUMBER LITERATE PER THOUSAND MALES SHOWN THUS 4

the trading communities the variations are not so noticeable, as progress is more even. The Rajput though high in social scale does not take kindly to learning. The literate males per mille among the Rajputs are 167. The corresponding

Literacy in certain Rajput septs.

Rajput sept.	Literate males per mille aged 7 and over.
1	2
Baghel	311
Parihar	207
Bundela	195
Gahlot	33

figures for Brahman and Bania castes are 265 and 501. The Baghel clan with its aptitude for Bagheli and thanks to the keen interest of the Rulers of Rewa to develop this dialect, shows the highest proportion of literacy. The Parihars and the Bundelas come next in the order named. The Gahlots are the most backward and their proportion is nearly the same as in some of the backward classes. With a view to recapitulate the foregoing points and to

bring out the contrast between the three upper castes, the marginal table gives the figures for them. The Bania leads the way followed after a considerable distance by the Brahmans. The Rajput occupies the third place. The Dakshani Brah-

Literacy in the three upper castes.

Caste.	NUMBER OF LITERATES PER MILLE AGED 7 AND OVER.		
	Total.	Males.	Females.
1	2	3	4
Brahman	152	265	27
Bania	278	501	34
Rajput	98	167	21

man, isolated from the generic Brahman group, occupies a place far higher than any caste or sub-caste in Central India.

In Subsidiary Table V the castes have been shown in the order of decreasing male literacy in column 3 within each broad classification. It is not therefore necessary to repeat the figures here. All the castes from Jat to Kachhi are good agricultural castes and there are also few low or servile castes in between. They are followed by the wandering or degraded or criminal

tribes like Sondhia, Moghia, Banjara, Kotwal and Sor. Next come the depressed classes. The only point worth noticing is the male literacy amongst Mehtar. This is encouraging though unexpected. The Balai has some pretension to literacy as in Malwa he is the village menial and a Government servant. This has been an inducement to some to take to learning. Finally come the primitive tribes. Only 2 males per mille are literate amongst the Tribal Bhils. The Chamar beats him by having 4 literate males per mille.

162. Female literacy.—Where the education of males is backward, it cannot be expected that we should find a high proportion of female literacy. There

Female literacy in certain castes.

Caste.	LITERATES PER MILLE AGED 7 AND OVER.	
	Males.	Females.
1	2	3
Brahman, Dakshani	884	419
Brahman, Shrimali	756	159
Bania, Mahesri	713	68
Bania, Oswal	596	56
Bania, Gahoi	469	15
Rajput, Baghel	311	54
Brahman, Sarwaria	198	5

are only 9 females per mille who are literate in all the age-periods. It rises to 14 in the period 15-20. This figure represents the high-water mark of female literacy. If we scrutinise by localities in Subsidiary Table II, the number of literate females per mille is below 10 in the age-period 15-20 in most of the States in the East excepting Maihar where it is 18. In the West it is nowhere over 45 per mille. In the cities where female education receives some encouragement, Indore City has 146 female literates per mille. In Bhopal, owing to the effect of Pardah among the

large Muslim community there the proportion is 80 per mille. The general factors which militate against the spread of literacy among the females in Indian society such as the Pardah system, early marriage or orthodox ideas against sending girls to school, absence of schools for girls and trained women teachers, are well known and require no repetition. Our statistics show that the men merely acquire literacy because they have to. There is yet no genuine desire to educate the females and no consciousness of the cultural aspects of literacy. The marginal table gives the proportion of female literacy per mille amongst those castes where the males are highly literate. The disparity is glaring and will continue so long as there is no higher cultural level among men or as long as women are dormant. The Dakshani Brahman community

stands as a class by itself. In column 4 of the Subsidiary Table it will be seen that the female proportion is never more than 4 per mille in the agricultural classes and down below the eye has to catch with difficulty a figure amidst the plethora of dashes. The picture of female literacy is altogether dismal and dark.

163. **Urban and rural literacy.**—The variation in literacy between the urban and rural areas is important to emphasise the point that literacy follows urbanization and this tendency is marked in Central India

Literacy in Cities and in the surrounding Rural areas.

Locality.	TOTAL LITERATE.		
	PROPORTION PER MILLE AGED 5 AND OVER.		
	Persons.	Males.	Females.
1	2	3	4
City of Indore	274	386	113
Rest of Indore State (excluding Indore City, Residency and Mhow Cantonment).	64	114	9
City of Bhopal	146	220	58
Rest of Bhopal State	26	47	3
City of Ratlam	237	373	76
Rest of Ratlam State	30	55	3

where the literate communities are found in few urban centres. They add considerably to the general literacy figures and when the urban literacy figures are excluded as in the table given here, we see the great drop in the proportions. In Indore State as a whole there are 93 persons per mille who are literate in all ages, the male and female proportions per mille being 157 and 23 respectively. The urban influence on female literacy is seen in the proportion of female

literate in the city and in the rest of the State. In Ratlam the masking effect of city figures is again clearly brought out. The total number of literates in Ratlam State is 9,435. In the City of Ratlam the total number of literates is 7,719. The proportion per mille for the State in all ages is 104 and by sex 174 males and 128 females.

164. **Literacy in English.**—The absolute figures for literacy in English are 26,918 males and 2,745 females. This means in Central India 5 persons per mille are literate in English

English literacy in British Indian Provinces.

Province.	NUMBER PER MILLE OF ENGLISH LITERATES AGED 5 AND OVER.		
	Persons.	Males.	Females.
	1	2	3
Bengal	25	43	5
Madras	14	26	3
Burma	13	20	5
Punjab	11	19	2
United Provinces	6	11	1
Central Provinces	6	11	1
Bihar and Orissa	5	9	1
Rajputana Agency	3	5	1

and if we want to know by sex, 9 males per mille and 1 female per mille claim literacy in English. The marginal table gives figures for some of the principal British Indian Provinces and for the Rajputana Agency exclusive of Ajmer-Merwara. At least one British Indian Province is in the same position as this Agency. Amongst the important Indian States, Gwalior and Hyderabad are almost on level with Central

India whereas the States of Baroda, Mysore, Cochin and Travancore are far ahead of it, both from the point of general as well as of English literacy. Taking the figures from Subsidiary Table I, we find that the small community of Indian Christians show a higher proportion than other communities. The other Christians are mostly Europeans whose mother tongue is English. The Jains and the Muslims follow next. The Hindus have only 4 persons per mille literate in English. Only 6 Tribals have been returned as literates for the whole Agency. In Subsidiary Table IV, the distribution of English literacy by locality is given. The masculine literacy nowhere exceeds the Agency proportion of 9 per mille except in the States of central and western Malwa, Indore, Dhar, Dewas, Ratlam, Sailana and Sitamau. English literacy is concentrated chiefly in urban areas. Thus there are 12,803 male and 1,625 female literates in the three cities of Indore, Ratlam and Bhopal and the garrison station of Mhow. 53.6 per cent. of persons literate in English are therefore concentrated in those 4 places which again account for 59.2 per cent. of the total female literates. Considering the castes, English education has made little or no headway amongst many castes. In the literate community of Dakshani

Brahmans alone there are 463 male literates and 42 female literates per mille. The Mahesri Banias who stand high in general literacy have 51 males and 1 female

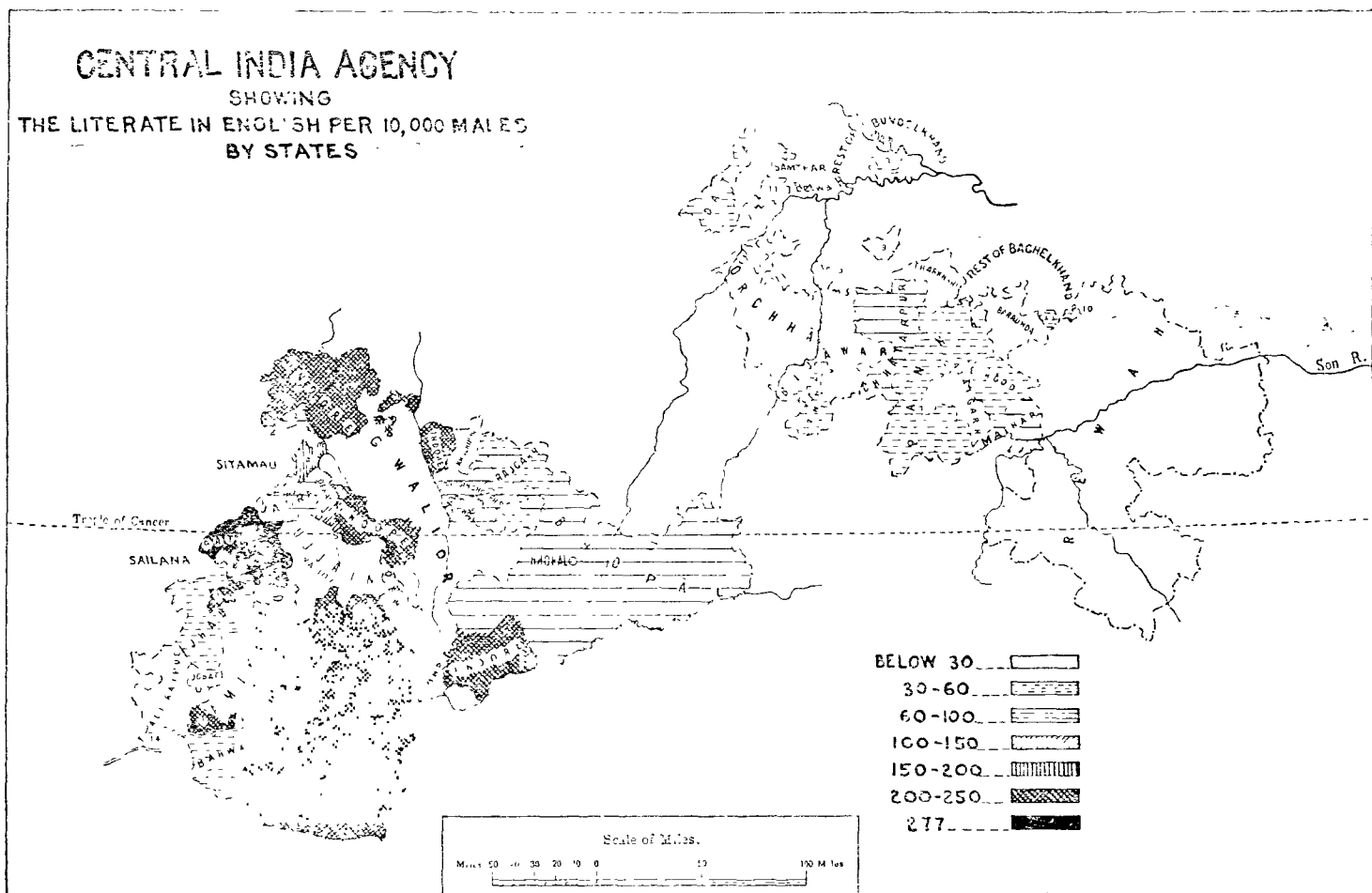

literate per mille while the Gahoi Banias have 5 males per mille. The Bundela Rajput shows some partiality to English literacy and this is an encouraging sign. The very low proportion of English literacy in castes which otherwise have a higher proportion of general literacy shows that few wish to continue beyond the stages of primary education to secondary or higher education where proficiency in English is necessary. Many are satisfied with the acquisition of the rudiments of general literacy.

In the last Census 19,955 persons (18,394 males and 1,561 females) were returned as English literates. 10 years ago 4 persons per mille (7 males and 1 female per mille) were literate in English. The female literacy shows a little increase in absolute figures though there is no change in the proportional ones. The decade has witnessed some progress in the literacy of males.

165. Progress of literacy by Religion and Locality.—Owing to the absence

Progress of literacy by Religion in the decade.

Religion	PROPORTION OF LITERATES AGED 15-20 PER MILLE IN			
	1931.		1921.	
	Males.	Females.	Males.	Females.
1	2	3	4	5
All Religions	112	14	78	11
Hindu	102	10	67	8
Muslim	239	43	224	34
Tribal	2	..	1	..
Jain	723	154	638	114
Indian Christian	639	577	566	582

of comparative figures it is not possible to study the general progress of education since 1901. It may however be worth while to note the progress made in the decade. A striking feature is the very considerable progress in literacy during the decade. While the population has increased by 10.5 per cent. the rise in general literacy is 55.3 per cent. The male literates have increased by 54.4 per cent. and the female literates

by 63.5 per cent. It is clear a new spirit is at work in many places and determined efforts are being made to provide educational facilities. In the marginal

table figures have been exhibited by sex for the age-period 15-20 amongst the adherents of different religions to show what progress they have made in the matter of education. Masculine literacy has made substantial progress amongst the Hindus and the Jains while the Muslims have little progress to their credit. The advance of female literacy amongst the Jains is a pleasing factor. The progress amongst Hindus and Muslims in the education of females is slow and halting. The Tribals statistically do not wish to be regressive and so have added one more per mille to swell their literate numbers. The decrease in female literates amongst the Indian Christians cannot be explained. The population returned as literate in the age-period 15-20 in any case may be assumed as having had the benefit of schooling in the preceding ten years and hence our figures record the progress made by different communities during the decade 1921-1931. In the table below will be found figures to exhibit the progress of literacy in few of the important States in the Agency.

Progress of literacy in Select States during the decade.

State.	NUMBER OF LITERATES PER MILLE AT CERTAIN AGE-PERIODS.											
	ALL AGES 10 AND OVER.				15-20.				20 AND OVER.			
	1931.		1921.		1931.		1921.		1931.		1921.	
	Males.	Females.	Males.	Females.	Males.	Females.	Males.	Females.	Males.	Females.	Males.	Females.
1	2	3	4	5	6	7	8	9	10	11	12	13
Indore	170	23	133	18	193	31	156	28	178	20	137	16
Bhopal	69	8	57	4	70	10	77	6	77	7	62	4
Rewa	72	4	42	2	75	5	38	4	79	4	49	2
Dhar	150	13	115	9	180	17	140	13	158	12	118	8
Orghha	66	2	45	1	68	3	43	2	74	2	49	1
Panna	75	4	37	2	78	5	34	2	83	4	42	2
Sitamau	184	21	121	13	189	25	121	18	199	20	133	13
Ratlam	195	31	181	27	195	43	197	43	217	30	197	24
Datia	121	4	112	3	135	4	119	4	131	4	113	3
Nagod	116	6	107	10	144	7	128	13	120	5	115	9
Jhabua	55	9	65	6	62	12	73	7	62	8	68	6
Ali-Rajpur	35	4	33	5	39	6	31	5	40	4	37	5

Of the three principal States, Bhopal stands lowest in the order of literacy. There are 69 male literates per mille in all ages ten and over. In the age-period 15-20, as compared with 1921, there is a drop in the proportions of male literates. In the States of Indore, Dhar and Sitamau, we notice considerable progress during the decade. On the other hand in Jhabua there is a set-back and in the adjacent State of Ali-Rajpur, little progress has been made. These States contain a large Bhil population and over 97 per cent. of the population is illiterate.

166. Remarks on educational tendencies.—An attempt was made in this Census to obtain information regarding the educated unemployed. It was attended with complete failure in this Agency. In the City of Indore, owing to mismanagement on the part of the local Census Officials, the forms were not distributed; otherwise few returns could have been secured. For it is only in this place where the problem of the unemployment of educated persons exists. From the point of view of Census, the inquiry was no doubt a failure but it represented a correct state of affairs. As a problem it does not exist outside one or two urban centres. As a disease this kind of unemployment manifests itself where education has made progress and turned out an intellectual proletariat beyond the needs and requirements of any locality. A large number of our local literates are mere smatterers and they get absorbed in lowly walks of life on low economic wages. In the rural areas, there is not so much unemployment as intolerable *ennui*. The first effect of schooling and acquisition of literacy is to drive the rural boy to the urban areas and to make a complete misfit of him if he ever wishes at all to return to his native surroundings. The analysis of our Census statistics has shown the prevalence of literacy by religion, sex, locality and caste. There we have noted that it is still confined to few urban areas; restricted to a very limited class; it is

acquired as a matter of necessity by few castes, while the bulk of the population is yet untouched. There is yet no organised attempt towards what is popularly known as mass education. Whether it is desirable or feasible or practicable it is not for us to say. Our figures record a decided advance and assuming the same to be maintained in coming years, assisted by increasing efforts to spread education, we may be permitted to observe one or two things. In all future efforts towards the spread of literacy, the fact should be borne in mind that it is never advisable to create a deep chasm between the different strata of society by the spread of uneven education. Secondly educational efforts should never result in draining the countryside by creating discontent and concentrating them in few urban centres. Thirdly education of the right kind to the masses is a necessity if they should be able to protect themselves against ignorance, superstition and apathy. We cannot in a Census Report embark upon a discussion of such wider educational problems. We rest content with the hope that the figures we provide may help those who some day or other will have to face the problem of educating the population on the right, preferably hitherto untrodden lines of progress.

SUBSIDIARY TABLE I.

Literacy by Age, Sex and Religion.

Religion.	NUMBER PER MILLE WHO ARE LITERATE.											NUMBER PER MILLE WHO ARE ILLITERATE.			NUMBER PER MILLE WHO ARE LITERATE IN ENGLISH.		
	FOR ALL AGES 5 AND OVER.			5—10.		10—15.		15—20.		20 AND OVER.		Total.	Male.	Female.	Total.	Male.	Female.
	Total.	Male.	Female.	Male.	Female.	Male.	Female.	Male.	Female.	Male.	Female.						
1	2	3	4	5	6	7	8	9	10	11	12	13	14	15	16	17	18
All Religions	52	92	9	35	7	61	10	112	14	111	9	948	908	991	5	9	1
Hindu	46	83	7	31	5	57	8	102	10	100	6	954	917	993	4	7	..
Muslim	119	198	28	79	20	128	31	239	43	235	27	881	802	972	13	23	1
Tribal	1	2	1	..	2	..	2	..	999	998	1,000
Jain	387	637	100	306	87	498	130	723	154	709	88	613	363	900	24	44	1
Christian	613	672	530	342	368	488	504	787	622	746	572	387	328	470	462	529	369
Indian Christian	453	479	425	276	325	430	462	639	577	523	409	547	521	575	235	247	222
Others	945	965	896	719	622	883	885	977	851	981	946	55	35	104	932	956	874
Others	427	547	277	277	217	382	246	591	314	614	292	573	453	723	169	226	96

SUBSIDIARY TABLE II.

Literacy by Age, Sex and Locality.

Agency, Natural Divisions and States.	NUMBER PER MILLE WHO ARE LITERATE.												
	ALL AGES 5 AND OVER.			5—10.		10—15.		15—20.		20 AND OVER.			
	Total.	Male.	Female.	Male.	Female.	Male.	Female.	Male.	Female.	Male.	Female.		
1	2	3	4	5	6	7	8	9	10	11	12		
CENTRAL INDIA AGENCY	52	92	9	35	7	61	10	112	14	111	9		
West	66	113	15	46	11	77	16	139	21	134	14		
British Pargana of Manpur	126	20	48	91	46	162	76	255	71	218	36		
Indore	93	157	23	73	21	114	27	193	31	178	20		
<i>Bhopal Agency.</i>													
Bhopal	36	62	7	23	5	37	8	70	10	77	7		
Khilchipur	28	50	4	15	3	30	4	62	4	60	4		
Narsingharh	51	89	8	34	6	62	10	105	10	105	7		
Rajgarh	43	74	7	32	4	52	7	86	9	87	6		
<i>Malwa Agency.</i>													
Dewas States	76	133	15	60	10	101	19	169	23	154	14		
Jaora	53	93	9	29	5	55	8	111	14	116	9		
Ratlam	104	174	28	54	13	102	27	195	43	217	30		
Sailana	78	137	15	51	12	95	16	158	21	169	15		
Sitamau	96	167	20	65	15	117	22	189	25	199	20		
<i>Southern Central India States Agency.</i>													
Ali-Rajpur	17	29	4	7	2	15	4	39	6	40	4		
Barwani	44	83	4	25	2	49	3	103	6	109	5		
Dhar	74	134	12	49	7	92	12	180	17	158	12		
Jhabua	28	47	8	16	6	28	10	62	12	62	8		
Jobat	27	48	6	12	1	28	2	77	12	62	7		
East	37	68	4	22	2	44	4	82	5	84	4		
<i>Bundelkhand Agency.</i>													
Ajaigarh	29	53	3	10	2	24	3	53	5	70	4		
Baoni	47	83	7	22	2	44	5	98	10	105	8		
Bijawar	24	45	2	12	..	29	1	52	3	56	2		
Charkhari	37	68	4	17	1	34	4	70	6	88	4		
Chhatarpur	49	88	7	28	5	53	9	102	12	108	7		
Datia	59	109	3	35	1	68	3	135	4	131	4		
Orchha	31	58	2	15	1	31	..	68	3	74	2		
Panna	36	67	3	24	2	44	4	78	5	83	4		
Samthar	45	83	4	21	2	41	3	86	3	106	4		
<i>Baghelkhand Agency.</i>													
Baraundha	29	50	6	13	2	25	3	52	7	67	7		
Kothi	52	96	7	48	6	89	9	127	8	106	7		
Maihar	41	71	12	29	4	102	12	159	18	57	13		
Nagod	55	104	6	36	6	79	9	144	7	120	5		
Rewa	34	64	4	22	2	42	3	75	5	79	4		
Sohawal	49	93	6	34	1	59	4	104	8	117	8		
Rest of Central India Agency	39	71	6	21	4	37	6	76	8	88	6		
Cities	234	342	91	176	84	275	118	399	124	373	81		
West	234	342	91	176	84	275	118	399	124	373	81		
Indore	274	386	113	237	130	337	162	444	146	408	94		
Bhopal	146	220	58	87	37	136	63	255	80	261	58		
Ratlam	237	373	76	148	5	304	81	421	117	419	75		
East													
						There is no City.							

SUBSIDIARY TABLE III.

Literacy by Religion, Sex and Locality.

Agency, Natural Divisions and States.	NUMBER PER MILLE WHO ARE LITERATE.											
	HINDU.		MUSLIM.		TRIBAL.		JAIN.		CHRISTIAN.		OTHERS.	
	Male.	Female.	Male.	Female.	Male.	Female.	Male.	Female.	Male.	Female.	Male.	Female.
1	2	3	4	5	6	7	8	9	10	11	12	13
CENTRAL INDIA AGENCY	83	7	198	28	2	..	687	100	672	530	547	277
West	102	11	211	33	2	..	684	124	669	514	542	273
British Pargana of Manpur	307	43	452	98	12	..	833	143	483	580
Indore	138	17	241	37	10	..	752	161	821	661
<i>Bhopal Agency.</i>												
Bhopal	46	2	167	40	2	1	365	30	630	612
Khilchipur	47	3	163	28	857
Narsinggarh	82	7	193	16	700	178	833	1,000
Rajgarh	66	5	200	26	587	57	833	1,000
<i>Mahwa Agency.</i>												
Dewas States	121	14	181	18	11	..	780	125	302	250
Jaora	62	5	181	19	627	78	500	167
Ratlam	188	22	237	37	767	150	594	515
Sailana	169	20	318	37	826	70	400	400
Sitamau	151	16	160	20	773	189	857	889
<i>Southern Central India States Agency.</i>												
Ali-Rajpur	20	2	334	31	700	250	207	164
Barwani	74	2	378	33	729	190	609	333
Dhar	128	10	227	12	1	..	757	124	681	602
Jhabua	168	25	259	30	670	112	166	191
Jobat	28	1	440	39	929	133	522	380
East	65	3	149	12	1	..	491	29	725	766	626	249
<i>Bundelkhand Agency.</i>												
Ajaigarh	47	3	134	10	528	33	1,000
Baoni	70	3	170	33	429	200
Bijawar	40	1	138	5	327	16	1,000	667
Charkhari	65	3	133	9	410
Chhatarpur	79	5	216	29	607	51	570	730
Datia	107	3	131	13	590	55	800	1,000
Orchha	48	2	115	6	491	15	846	1,000
Panna	60	3	161	10	460	19	900	778
Samthar	84	4	70	1,000
<i>Baghelkhand Agency.</i>												
Baraundha	59	7	82	26
Kothi	117	9	102	..	1
Maihar	71	12	55	9	1,000	231	1,000	1,000
Nagod	99	5	224	6	833	250
Rewa	62	3	158	11	2	..	753	140	826	862
Sohawal	99	7	186	2	457	19	500
Rest of Central India Agency	63	4	139	19	1	..	445	29	564	327
Cities	357	94	251	65	32	..	780	211	599	539	1,000	..
West	357	94	251	65	32	..	780	211	599	539	1,000	..
Indore	391	121	284	76	810	266	665	577
Bhopal	190	30	224	66	32	..	545	110	537	573	1,000	..
Ratlam	352	51	263	43	794	177	600	518
East	There is no City.											

SUBSIDIARY TABLE IV.

English Literacy by Age, Sex and Locality.

Agency, Natural Divisions and States.		LITERATE IN ENGLISH PER 10,000.																			
		1931.										1921.									
		5—10.		10—15.		15—20.		20 AND OVER.		ALL AGES 5 AND OVER.		5—10.		10—15.		15—20.		20 AND OVER.		ALL AGES 5 AND OVER.	
		Male.	Female.	Male.	Female.	Male.	Female.	Male.	Female.	Male.	Female.	Male.	Female.	Male.	Female.	Male.	Female.	Male.	Female.	Males.	Females.
1	2	3	4	5	6	7	8	9	10	11	12	13	14	15	16	17	18	19	20	21	
CENTRAL INDIA AGENCY	16	6	43	11	151	16	113	10	92	10	5	2	31	6	114	10	88	7	68	6	
WEST	25	10	70	19	247	28	177	17	146	18	8	5	48	11	214	20	138	11	109	10	
British Pargana of Manipur.	23	24	73	79	300	119	400	41	291	55	Figures are not available.										
Indore	46	23	117	36	411	49	288	32	243	33	8	5	38	22	362	40	229	22	166	18	
<i>Bhopal Agency.</i>																					
Bhopal	13	4	33	8	112	13	98	9	77	8	3	2	14	7	62	6	85	5	53	4	
Khilchipur	3	4	28	..	27	2	20	2	4	..	48	..	26	..	20	..	
Narsinghgarh	12	..	55	3	160	6	68	1	69	2	4	..	12	..	60	..	25	1	23	..	
Rajgarh	11	5	30	7	109	7	67	3	58	4	16	..	63	3	28	1	24	1	
<i>Malwa Agency.</i>																					
Dewas States	22	2	74	11	187	11	142	7	120	8	6	..	62	3	416	2	140	2	131	2	
Jaora	..	3	24	2	110	4	98	5	74	4	4	..	47	..	96	7	64	3	54	2	
Ratlam	41	16	129	45	367	72	354	41	277	42	14	14	103	14	443	41	258	33	212	23	
Sailana	20	4	75	10	147	18	133	10	108	10	36	..	216	..	58	..	60	..	
Sitamau	43	..	136	..	324	7	166	3	162	3	15	..	51	22	263	..	93	1	88	4	
<i>Southern Central India States Agency.</i>																					
Ali-Rajpur	9	..	34	2	26	3	19	2	1	2	4	2	20	6	30	2	19	3	
Barwani	11	1	33	..	106	3	69	1	56	1	1	2	16	2	130	8	77	1	55	2	
Dhar	16	2	53	6	217	11	132	6	111	6	19	3	114	5	74	3	57	3	
Jhabua	11	2	28	12	61	20	47	9	30	9	2	..	24	2	66	3	30	2	25	2	
Jobat	49	11	61	5	37	4	8	..	80	..	36	..	27	..	
EAST	5	1	15	2	48	3	40	2	32	2	2	..	14	1	33	1	31	2	23	1	
<i>Bundelkhand Agency.</i>																					
Ajaigarh	11	..	44	2	33	1	26	1	3	..	16	3	16	..	11	..	
Baoni	16	..	9	18	..	11	..	
Bijawar	..	1	3	..	8	..	19	1	13	2	2	..	4	..	7	..	5	..	
Charkhari	3	..	8	..	35	..	51	..	24	11	..	22	..	17	1	14	..	
Chhatarpur	12	2	40	2	130	10	98	8	81	7	20	5	49	10	131	2	154	11	103	9	
Datia	8	..	24	1	81	1	66	2	54	2	43	..	64	2	43	..	38	..	
Orchha	2	..	6	..	29	3	24	2	18	1	5	..	14	..	13	..	10	1	
Panna	6	3	24	4	59	3	43	2	36	2	3	..	17	..	32	..	20	2	18	1	
Samthar	10	..	46	..	36	4	28	2	8	..	5	..	4	..	31	1	24	1	
<i>Baghelkhand Agency.</i>																					
Baraundha	11	..	10	..	7	..	Figures are not available.										
Kothi	7	..	45	..	39	..	24	26	..	13	..	
Maihar	18	..	43	11	94	6	85	10	70	8	10	..	17	8	33	1	21	1	
Nagod	10	..	30	2	85	3	61	1	52	1	14	..	40	..	40	1	28	..	
Rewa	5	..	13	1	41	3	33	2	26	2	2	..	13	1	29	2	25	2	19	1	
Sohawal	10	..	29	..	52	..	53	2	42	1	3	5	..	18	2	12	1	
Rest of Central India Agency	6	1	10	1	27	9	50	5	36	4	Figures are not available.										

SUBSIDIARY TABLE V.

Literacy by caste 1931 and 1921.

Caste.	1931 POPULATION 7 YEARS AND OVER.									1921 POPULATION 5 YEARS AND OVER.								
	NO. PER 1,000 WHO ARE						NO. PER 10,000.			NO. PER 1,000 WHO ARE						NO. PER 10,000.		
	Literate.			Illiterate.			Literate in English.			Literate.			Illiterate.			Literate in English.		
	Total.	Males.	Females.	Total.	Males.	Females.	Total.	Males.	Females.	Total.	Males.	Females.	Total.	Males.	Females.	Total.	Males.	Females.
1	2	3	4	5	6	7	8	9	10	11	12	13	14	15	16	17	18	19
Dakshani (Brahman)	677 <i>571</i>	884 <i>760</i>	419 <i>345</i>	323 <i>429</i>	116 <i>240</i>	581 <i>655</i>	2,758 <i>2,326</i>	4,633 <i>3,984</i>	422 <i>348</i>	Figures not available.								
Shrimali (Brahman)	483 <i>416</i>	756 <i>658</i>	159 <i>135</i>	517 <i>584</i>	24 <i>342</i>	841 <i>865</i>	1,208 <i>1,041</i>	2,171 <i>1,890</i>	61 <i>52</i>	379 <i>328</i>	646 <i>557</i>	98 <i>87</i>	621 <i>672</i>	354 <i>443</i>	902 <i>919</i>	777 <i>673</i>	1,486 <i>1,281</i>	26 <i>30</i>
Mahesri (Banias)	415 <i>352</i>	713 <i>607</i>	68 <i>57</i>	585 <i>648</i>	287 <i>393</i>	932 <i>943</i>	279 <i>236</i>	506 <i>431</i>	13 <i>11</i>	316 <i>292</i>	548 <i>511</i>	36 <i>33</i>	684 <i>708</i>	452 <i>489</i>	964 <i>967</i>	102 <i>94</i>	184 <i>171</i>	3 <i>2</i>
Kayastha	413 <i>343</i>	674 <i>559</i>	112 <i>93</i>	587 <i>657</i>	326 <i>441</i>	888 <i>907</i>	622 <i>516</i>	1,112 <i>923</i>	55 <i>46</i>	Figures not available.								
Oswal (Banias)	352 <i>301</i>	596 <i>514</i>	56 <i>48</i>	648 <i>699</i>	404 <i>486</i>	944 <i>952</i>	261 <i>223</i>	461 <i>398</i>	18 <i>15</i>	290 <i>266</i>	465 <i>436</i>	45 <i>41</i>	710 <i>734</i>	535 <i>564</i>	955 <i>959</i>	120 <i>111</i>	207 <i>194</i>	.. <i>..</i>
Gahoi (Banias)	253 <i>203</i>	469 <i>392</i>	15 <i>12</i>	747 <i>797</i>	531 <i>608</i>	985 <i>988</i>	28 <i>23</i>	53 <i>44</i>	.. <i>..</i>	165 <i>148</i>	313 <i>281</i>	4 <i>3</i>	835 <i>852</i>	687 <i>719</i>	996 <i>997</i>	10 <i>9</i>	20 <i>18</i>	.. <i>..</i>
Baghela (Rajput)	177 <i>146</i>	311 <i>258</i>	54 <i>44</i>	823 <i>854</i>	689 <i>742</i>	946 <i>956</i>	96 <i>80</i>	194 <i>161</i>	6 <i>5</i>	64 <i>58</i>	97 <i>88</i>	33 <i>30</i>	936 <i>942</i>	903 <i>912</i>	967 <i>970</i>	14 <i>13</i>	27 <i>24</i>	3 <i>3</i>
Pathan	133 <i>109</i>	222 <i>185</i>	27 <i>22</i>	867 <i>891</i>	778 <i>815</i>	973 <i>978</i>	161 <i>131</i>	284 <i>235</i>	15 <i>12</i>	89 <i>79</i>	155 <i>138</i>	16 <i>14</i>	911 <i>921</i>	845 <i>862</i>	984 <i>986</i>	70 <i>62</i>	127 <i>114</i>	6 <i>6</i>
Sheikh	128 <i>106</i>	214 <i>180</i>	28 <i>23</i>	872 <i>894</i>	786 <i>890</i>	972 <i>977</i>	162 <i>124</i>	288 <i>243</i>	14 <i>11</i>	86 <i>77</i>	151 <i>135</i>	15 <i>13</i>	914 <i>923</i>	949 <i>865</i>	985 <i>987</i>	75 <i>67</i>	140 <i>126</i>	2 <i>2</i>
Parihar (Rajput)	181 <i>157</i>	207 <i>169</i>	20 <i>16</i>	819 <i>843</i>	793 <i>831</i>	980 <i>984</i>	56 <i>49</i>	108 <i>88</i>	5 <i>4</i>	82 <i>73</i>	137 <i>121</i>	23 <i>21</i>	918 <i>927</i>	863 <i>879</i>	977 <i>979</i>	16 <i>14</i>	27 <i>24</i>	4 <i>4</i>
Sarwaria (Brahman)	103 <i>85</i>	198 <i>164</i>	5 <i>4</i>	897 <i>915</i>	802 <i>836</i>	995 <i>996</i>	20 <i>17</i>	38 <i>32</i>	1 <i>1</i>	54 <i>48</i>	106 <i>95</i>	3 <i>3</i>	946 <i>952</i>	894 <i>905</i>	997 <i>997</i>	7 <i>6</i>	12 <i>11</i>	1 <i>1</i>
Bundela (Rajput)	119 <i>99</i>	195 <i>166</i>	26 <i>21</i>	881 <i>901</i>	805 <i>834</i>	974 <i>979</i>	129 <i>108</i>	227 <i>194</i>	10 <i>8</i>	82 <i>74</i>	139 <i>126</i>	18 <i>16</i>	918 <i>926</i>	861 <i>874</i>	982 <i>984</i>	68 <i>61</i>	123 <i>111</i>	5 <i>4</i>
Jat	46 <i>38</i>	82 <i>68</i>	3 <i>2</i>	954 <i>962</i>	918 <i>932</i>	997 <i>998</i>	19 <i>16</i>	35 <i>30</i>	.. <i>..</i>	Figures not available.								
Mali	33 <i>27</i>	61 <i>51</i>	3 <i>2</i>	967 <i>973</i>	939 <i>949</i>	997 <i>998</i>	15 <i>12</i>	28 <i>22</i>	1 <i>2</i>	Figures not available.								
Jolaha	33 <i>28</i>	64 <i>54</i>	2 <i>2</i>	967 <i>972</i>	936 <i>946</i>	998 <i>998</i>	7 <i>5</i>	18 <i>11</i>	.. <i>..</i>	Figures not available.								
Nai	31 <i>25</i>	57 <i>47</i>	3 <i>2</i>	969 <i>975</i>	943 <i>953</i>	997 <i>998</i>	11 <i>9</i>	22 <i>18</i>	.. <i>..</i>	Figures not available.								
Teli	30 <i>24</i>	57 <i>46</i>	2 <i>1</i>	970 <i>976</i>	943 <i>954</i>	998 <i>999</i>	5 <i>4</i>	9 <i>7</i>	1 <i>..</i>	Figures not available.								
Gujar	28 <i>23</i>	50 <i>41</i>	1 <i>1</i>	972 <i>977</i>	950 <i>959</i>	999 <i>999</i>	5 <i>4</i>	10 <i>8</i>	.. <i>..</i>	16 <i>14</i>	28 <i>26</i>	2 <i>2</i>	984 <i>986</i>	972 <i>974</i>	998 <i>998</i>	2 <i>1</i>	3 <i>3</i>	.. <i>..</i>
Kurmi	30 <i>24</i>	57 <i>47</i>	1 <i>1</i>	970 <i>976</i>	943 <i>953</i>	999 <i>999</i>	2 <i>1</i>	3 <i>2</i>	.. <i>..</i>	Figures not available.								
Gahlot (Rajput)	17 <i>14</i>	33 <i>27</i>	1 <i>1</i>	983 <i>986</i>	967 <i>973</i>	999 <i>999</i>	3 <i>3</i>	7 <i>5</i>	.. <i>..</i>	13 <i>10</i>	23 <i>18</i>	3 <i>2</i>	987 <i>990</i>	977 <i>982</i>	997 <i>998</i>	15 <i>12</i>	29 <i>23</i>	.. <i>..</i>
Lodhi	16 <i>13</i>	31 <i>25</i>	1 <i>..</i>	984 <i>987</i>	969 <i>975</i>	999 <i>1,000</i>	3 <i>3</i>	7 <i>5</i>	.. <i>..</i>	Figures not available.								
Ahir	15 <i>12</i>	27 <i>22</i>	1 <i>1</i>	985 <i>988</i>	973 <i>978</i>	999 <i>999</i>	6 <i>5</i>	12 <i>10</i>	.. <i>..</i>	Figures not available.								
Koli	10 <i>8</i>	20 <i>16</i>	.. <i>..</i>	990 <i>992</i>	980 <i>984</i>	1,000 <i>1,000</i>	6 <i>5</i>	12 <i>10</i>	.. <i>..</i>	Figures not available.								
Dhobi	10 <i>8</i>	20 <i>16</i>	1 <i>..</i>	990 <i>992</i>	980 <i>984</i>	999 <i>1,000</i>	3 <i>2</i>	6 <i>5</i>	.. <i>..</i>	Figures not available.								
Gadaria	7 <i>5</i>	12 <i>10</i>	.. <i>..</i>	993 <i>995</i>	988 <i>990</i>	1,000 <i>1,000</i>	2 <i>2</i>	5 <i>4</i>	.. <i>..</i>	Figures not available.								
Kacchi	5 <i>4</i>	10 <i>8</i>	.. <i>..</i>	995 <i>996</i>	990 <i>992</i>	1,000 <i>1,000</i>	1 <i>1</i>	3 <i>2</i>	.. <i>..</i>	Figures not available.								

NOTE.—Proportion of literates to total strength of the caste is noted in italics.

SUBSIDIARY TABLE V—*concl.*

Literacy by caste 1931 and 1921—*concl.*

Caste.	1931 POPULATION 7 YEARS AND OVER.									1921 POPULATION 5 YEARS AND OVER.								
	NO. PER 1,000 WHO ARE						NO. PER 10,000.			NO. PER 1,000 WHO ARE						NO. PER 10,000.		
	Literate.			Illiterate.			Literate in English.			Literate.			Illiterate.			Literate in English.		
	Total.	Males.	Females.	Total.	Males.	Females.	Total.	Males.	Females.	Total.	Males.	Females.	Total.	Males.	Females.	Total.	Males.	Females.
1	2	3	4	5	6	7	8	9	10	11	12	13	14	15	16	17	18	19
Sondhia	9 8	17 13	.. 2	991 992	983 987	1,000 998	1 6	2 11	..	2 2	5 4	..	998 998	995 996	1,000 1,000	..	1 1	..
Moghia	8 6	15 12	..	992 994	985 988	1,000 1,000	} Figures not available.								
Banjara	7 5	12 10	..	993 995	988 990	1,000 1,000	} Figures not available.								
Kotwal	5 4	11 9	..	995 996	989 991	1,000 1,000	2 2	4 4	..	} Figures not available.								
Sor	1,000 1,000	1,000 1,000	1,000 1,000	} Figures not available.								
Mehtar	16 11	31 21	1 1	984 989	969 979	999 999	6 4	10 7	..	} Figures not available.								
Balal	7 5	13 10	..	993 995	987 990	1,000 1,000	1 1	1 1	..	} Figures not available.								
Chamar	2 1	4 3	..	998 999	996 997	1,000 1,000	..	1 1	..	} Figures not available.								
Bansphor	1 1	2 2	..	999 999	998 998	1,000 1,000	1 1	2 1	..	} Figures not available.								
Bhil	1 1	2 1	..	999 999	998 999	1,000 1,000	..	1	4 4	9 7	..	996 996	991 993	1,000 1,000
Gond	3 2	6 4	..	997 998	994 996	1,000 1,000	4 3	7 6	..	996 997	993 994	1,000 1,000
Baiga	1,000 1,000	1,000 1,000	1,000 1,000	} Figures not available.								

NOTE.—Proportion of literates to total strength of the caste is noted in italics.

SUBSIDIARY TABLE VI.

Progress of Literacy.

Agency and Natural Divisions.	NUMBER PER MILLE WHO ARE LITERATE 1931.						NUMBER PER MILLE WHO ARE LITERATE 1921.					
	ALL AGES 10 AND OVER.		15—20.		20 AND OVER.		ALL AGES 10 AND OVER.		15—20.		20 AND OVER.	
	Male.	Female.	Male.	Female.	Male.	Female.	Male.	Female.	Male.	Female.	Male.	Female.
	1	2	3	4	5	6	7	8	9	10	11	12
CENTRAL INDIA AGENCY	103	10	112	14	111	9	75	7	78	11	81	6
West	125	15	139	21	134	14	99	11	117	18	104	10
East	77	4	82	5	84	4	49	2	46	6	55	2

NOTE.—Figures prior to the Census of 1921 are not available.

SUBSIDIARY TABLE VII.

Proportion of Literacy at certain ages.

Age groups.	TOTAL POPULATION.			TOTAL LITERATE.			TOTAL LITERATE IN ENGLISH.		
	Persons.	Males.	Females.	Persons.	Males.	Females.	Persons.	Males.	Females.
1	2	3	4	5	6	7	8	9	10
Total	1,000	1,000	1,000	1,000	1,000	1,000	1,000	1,000	1,000
7—13 years	211	215	206	117	110	195	57	49	142
14—16 years	87	90	84	86	84	112	93	87	142
17—23 years	146	143	150	190	187	219	274	279	226
24 years and over	556	552	560	607	619	474	576	585	490

NOTE.—This table gives proportionate figures.

SUBSIDIARY TABLE VIII.

Number of Institutions and pupils according to the returns of Educational Department.

Class of Institution.	Number of Institutions.	Scholars.
1	2	3
All kinds	1,650	114,638
For Males and Females	93	5,454
High School	1	143
Primary School	88	5,140
Special School	3	144
Middle School	1	27
For Males	1,411	98,472
Arts College	3	1,324
High School	27	7,721
Primary School	1,233	67,395
Special School	41	2,786
Training School	3	75
Vedic School	16	635
Middle School	88	18,536
For Females	146	10,712
High School	2	740
Middle School	3	441
Primary School	136	9,161
Special School	5	370
Medical School	1	286
Daly College	1	76

CHAPTER X.

Language.

167. **The basis of the figures.**—The information regarding the languages was obtained from column 14 of the General Schedule. The following instructions ran on the Cover :—

Enter each person's mother tongue. In the case of infants and deaf-mutes the language of the mother should be entered. In filling up the Schedule the enumerator must enquire what is his or her mother tongue : whether he or she speaks Marwari, Malvi, Rangari, Gujarati, Purbi. In reply he or she will tell the mother tongue.

An additional column was provided in this Census to record the Subsidiary language or languages habitually spoken by each person in addition to his mother tongue in daily or domestic life.

168. **New features of the language returns.**—The precise nature of the instructions that only the familial language should be returned in column 14 facilitated an accurate record of the mother tongue of the whole population. It gave no room for doubtful entries and no choice for the immigrant elements in the population to enter the language of domicile. Nor was there any occasion to mistake a second language in ordinary and common use to one that is habitually used at home. The responses elicited with respect to the enquiry in column 15 have formed the basis for a study of the effect and extent of the phenomenon of bilingualism. An enquiry into this subject is one of the features of this Census and an interesting and very valuable feature. It has a twofold value—scientific and administrative. On the scientific side a study of bilingualism gives an insight as to how certain minor languages are being displaced by the stronger and more developed ones, and as to how two languages which overlap in an area interact on each other and to what cultural and social problems they give rise. On the administrative side bilingual statistics are of considerable use to the educationalist. Incidentally the figures for bilingualism will also indicate how far the common supposition that though the vast majority alike in their home and in their general conversation, speak one of the major languages of the country, a considerable number are practically bilingual,¹ is actually corroborated by the statistics.

169. **Accuracy of the returns.**—The record of bilingualism no doubt eliminates one source of error but there are other difficulties which stand in the way of an accurate record of the languages. The ordinary enumerator does not know the precise difference between Eastern and Western Hindi or Rajasthani, terms which are only known to the reader of the Linguistic Survey Volumes. Very often in recording the tribal languages, the enumerator would probably enter the tribal dialect without even questioning the person on the supposition the Bhil must speak Bhili though he may have abandoned it in favour of Malvi. Then there are inaccuracies due to obscure entries. These are however very few for this Agency. The practice followed in Central India works on the whole towards approximately accurate language returns. It is to record the dialects and the local dialect is always well-known to the enumerator and he is not likely to go wrong. This is necessary because the term Rajasthani is perhaps not even heard by any enumerator in Malwa. In the Bhopal Agency Malvi is called Umatwadi, in western Malwa it passes under the name of Rangari and Rajasthani embraces such dialects as Banjari, Sondhwari and Khichiwadi. The dialects are carefully classified in the Abstraction Office and grouped under the appropriate language according to the system of classification laid down by the Linguistic Survey. Our returns therefore ought to be fairly accurate. Having postulated certain reasons for the accuracy of the figures, it may appear strange to strike a discordant note when we mention the painful mutilations in the language returns of the Bhopal State. Since one or two previous Censuses there has been a feeling in this State that not only the Muslims but all the Hindus should be returned

¹ *India Report*, 1921, paragraph 152.

as speaking Urdu, which is claimed to be the language of the State. Advantage was taken of the present Census to give full expression to this feeling and the records were prepared in deliberate disregard of the actual facts. The result is best seen in the subjoined table.

Comparative figures for Gondi, Rajasthani and Urdu in Bhopal.

Language.	1931.		1921.		Assumed figures for 1931 on the basis of the proportions of 1921.
	Actual returns.	Percentage proportion to the total population.	Actual returns.	Percentage proportion to the total population.	
1	2	3	4	5	6
Gondi	8,359	1.15	13,315	1.92	14,000
Rajasthani	15,285	2.09	420,644	60.75	443,400
Urdu	697,065	95.49	243,879	35.22	257,000

The figures in column 6 are assumed on the basis of the proportions in 1921, just to give an idea as to the enormous variations brought about by the change in the Bhopal method of record. The figures for Rajasthani and Western Hindi are so much altered that it is not possible to make any small adjustments. Many Gonds are returned as speaking Urdu and nearly 90 per cent. of the Bhopal Gonds are shown as bilingual which in fact they are not to the extent the figures would show. No attempt has been made to straighten this tangle in the language table. In using the figures for Rajasthani and Western Hindi, it should be noted that the former is under-expressed while the strength of the latter is correspondingly inflated and further linguistically Bhopal is predominantly a Rajasthani area.

170. **Statistical reference.**—The results are embodied in Table XV which is divided into two parts: Part I gives the general distribution of the languages spoken as mother tongues and part II gives the area and extent of bilingualism. The languages in part I are tabulated according to the scheme of classification prescribed by the Linguistic Survey and the principal dialects of Central India are also shown under the respective languages. An appendix to the table gives further details of the dialects not shown in the main table together with their distribution. In addition to these detailed informations, three Subsidiary tables are given for further elucidation of the figures. They are:—

I—Distribution of total population by mother tongue according to Census.

II—Distribution by language of the population of States showing only the more important local languages.

III—Comparison of caste and language tables.

171. **Main features of the return.**—The distribution of the total population

Distribution by Linguistic Families and Groups.

Family, Sub-family, etc., of Languages.	Strength in 1931.	Proportion per 10,000 of total population.
1	2	3
A—Vernaculars of India	6,628,790	9,994
Austro-Asiatic Sub-family.	4,157	6
Dravidian family .	357,843	540
Indo-European family.	6,266,777	9,448
<i>Indo-Aryan Branch.</i>		
i. Mediate group .	1,490,431	2,247
ii. Central group .	4,714,652	7,108
iii. Southern group .	55,001	83
iv. Pahari group .	356	
Unclassed languages	2,404	4
Gypsy.		
B—Vernaculars of other Asiatic Countries, etc.	513	1
C—European Languages	3,487	5

by mother tongue, arranged according to Grierson Scheme, is given in Subsidiary Table I and the main figures extracted therefrom are exhibited in the marginal table. Out of ten mille of the population 9,994 claim as their mother tongue one or other of the vernaculars of India. Out of this proportion 6 per ten mille are assigned to the Austro-Asiatic family, 540 to the Dravidian family and 9,448 to the Indo-Aryan branch of the Indo-European family. The Austro-Asiatic sub-family is represented in very small numbers by the Korku language, which is not indigenous to Central India and is merely a spill-over from the Satpuras to the few scattered areas in those portions of Indore, Dhar and Bhopal States lying to the south of the Vindhya. The Dravidian family is divided

CENTRAL INDIA AGENCY SHEWING LINGUISTIC DISTRIBUTION

(N.B. THE THICK LINE SHOWS VERY APPROXIMATELY
THE LINGUISTIC BOUNDARY BETWEEN
WESTERN & EASTERN HINDI.)

- REFERENCES**
- HINDI PREDOMINANT
 - GONDI HATCHED BLACK
 - RAJASTHANI PREDOMINANT
 - BHILI HATCHED BLACK
 - BHILI PREDOMINANT
 - RAJASTHANI HATCHED BLACK

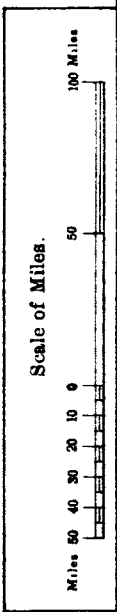
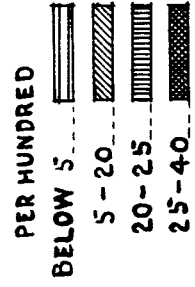
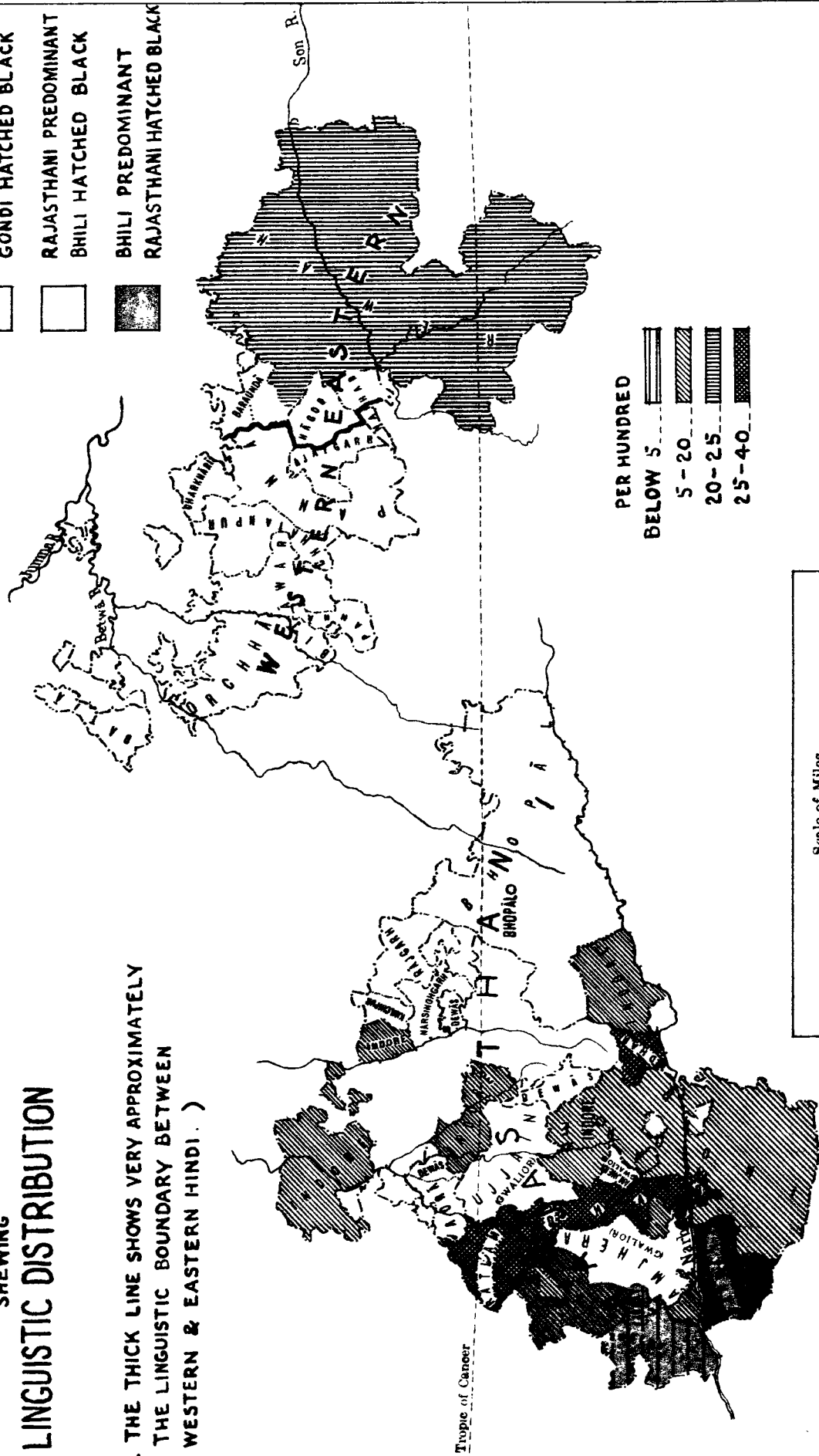

rural parts there is little disposition to return Urdu in preference to Malvi by the Muslims. A genuine gain by Western Hindi at the expense of Rajasthani is not therefore considerable. The decrease under others calls for no particular explanation.

173. **Geographical distribution.**—Linguistically Central India is a complex area and no one language can be said to be the dominant language of the whole region. The principal vernaculars of the Agency are Hindi (Eastern and Western), Rajasthani, Bhili and Gondi. The following table sets out the proportionate distribution of the languages in the different localities :—

Proportionate distribution of the principal vernaculars by locality.

State.	NUMBER PER 10,000 OF THE POPULATION WHOSE MOTHER TONGUE IS							
	Gondi.	Eastern Hindi.	Western Hindi.	Rajasthani.	Bhili.	Marathi.	Gujarati.	Others.
1	2	3	4	5	6	7	8	9
Central India	534	2,247	3,627	2,483	880	95	82	52
A. RAJASTHANI PREDOMINANT.								
<i>Northern and Eastern Malwa.</i>								
Bhopal	115	2	9,647	209	..	4	5	18
Narsingharh	13	9	727	9,136	20	4	32	59
Rajgarh	6	488	9,396	50	4	20	36
Khilchipur	8	113	9,840	2	4	25	8
<i>Central Malwa.</i>								
Indore	63	57	2,247	5,823	1,146	321	225	118
Dewas (Senior and Junior)	1	53	657	8,932	49	231	47	30
Dhar	9	25	708	6,148	2,549	186	293	82
<i>Western Malwa.</i>								
Ratlam	81	628	6,305	2,604	62	238	82
Sailana	21	230	6,035	3,581	17	101	15
Jaora	9	1,272	8,475	92	27	79	46
Sitamau	2	252	9,623	9	13	40	61
B. BHILI PREDOMINANT.								
<i>South-Western Malwa.</i>								
Ali-Rajpur	6	228	276	8,481	14	953	42
Jhabua	2	379	1,190	8,316	3	104	6
Barwani	26	312	2,607	5,831	118	517	589
C. WESTERN HINDI PREDOMINANT.								
<i>Bundelkhand.</i>								
Ajaigarh	296	80	9,611	3	4	1	..	5
Baoni	9,997	3
Bijawar	1	9,996	1	2	..
Charkhari	2	9,983	2	..	13
Chhatarpur	20	9,928	11	5	10	1	25
Datia	13	9,965	14	..	3	1	4
Orchha	1	9,988	2	1	1	2	5
Panna	1,194	8,784	15	..	1	2	4
Samthar	1	9,983	9	..	3	..	4
D. EASTERN HINDI PREDOMINANT.								
<i>Baghelkhand.</i>								
Baraundha	226	9,553	218	3
Kothi	522	9,121	175	4	6	172
Maihar	6	7,414	2,561	1	..	4	6	8
Nagod	9,701	291	3	5	..
Rewa	2,088	7,766	123	11	1	2	1	8
Sohawal	139	9,353	493	7	4	4

NOTE.—Bhopal is shown in Rajasthani area for reasons previously explained.

The above table shows very clearly the linguistic homogeneity of Baghelkhand and of Bundelkhand. In Malwa, the northern portions are homogeneous except in Bhopal. In Central Malwa, Indore is least homogeneous. Its linguistic diversity is due to several causes. The detached nature of the State is responsible for including diverse elements. Nearly 11 per cent. is accounted for by Bhili alone. The City of Indore and a considerable Muslim and immigrant population contribute heavily to the figures for Western Hindi and it has a proportion for this language higher than any other Malwa State. Being again the most important

Maratha State it has nearly 3 per cent. of Marathi speakers. Except in Barwani which lies in the Bhili area and whose borders march along the Khandesh district of the Bombay Presidency, the Marathi speakers are mainly concentrated in the three Maratha States of Dhar, Dewas and Indore. In Western Malwa, Rajasthani is in absolute majority in Sitamau and its numerical preponderance is slightly diminished in Jaora which has a considerable Muslim population and proportionately reduced still further in Ratlam and Sailana where it meets Bhili in the hilly portions of the States. In south-west Malwa Bhili preponderates in Ali-Rajpur where owing to its close proximity to Gujarat the place of honour next to the predominant language goes to Gujarati and Rajasthani speakers dwindle to less than three per cent. Numerically Bhili is still predominant in Barwani but unlike the two adjacent unopened States, the former has the valley of the Narbada and this is the reason why other languages have penetrated into this Bhili area.

174. Linguistic border Zones.—These figures give certain clue to follow up the linguistic border zones and to study the question of the overlapping of cultures which the language statistics disclose. Such an enquiry cannot be pursued here in detail but an attempt will be made to indicate very briefly the principal border zones. It may be premised that what is set out is only approximate, based on the Census figures, and it is never an easy matter to identify the boundaries of any language. Starting with the Bagheli-Bundeli border, Maihar is the only State where the proportion of Western Hindi rises to 26 per cent. Now the total speakers of Bundelkhandi in this State are 16,746 of whom 12,323 are in the Sabhaganj Tahsil. They form 42 per cent. of the total population of this Tahsil. Sabhaganj forms the westernmost portion of the State and it lies to the west of the railway line passing through the Banrer and Kaimur gap. Excepting this area, the rest of Maihar is a pure Bagheli tract. The border line next passes through the Nagod State which according to our figures is a Bagheli area. It will be seen from the table that Panna which lies in the Bundeli area has nearly 12 per cent. Bagheli speakers. The total Bagheli speakers in Panna are 25,323 of whom Singhpur returned 11,949 and Birsinghpur 12,873. This State is badly fragmented and Birsinghpur is situated in the midst of the pure Bagheli tract on the borders of Rewa. Singhpur is adjacent to our border zone which will have to bulge a little inside to include this small tract unless we consider the Bagheli of Singhpur more a Bundeli mixed with little Bagheli. The line would then proceed and include the minor Jagirs of Baghelkhand before it leaves the Agency. The Bagheli of these northern parts is not a pure one. The bulk of the returns is Gahora which is a broken dialect with a 'flavour' of Bundeli words. The present constitution of the Agency makes it difficult to assign a regular boundary between Western Hindi and Rajasthani. A small strip of Bhopal territory to the south of the Vindhya is included in the linguistic survey as lying in Bundeli zone but the Bhopal figures are unsatisfactory in the present Census. We may pass on to the Rajasthani-Bhili border in the south-west of the Agency. The curious and the interested will find in Appendix C to this Chapter detailed language statistics by Parganas for the States of Jhabua, Ali-Rajpur and Barwani where Bhili is dominant and for the States of Ratlam and Sailana and the Nimar district of Indore where Bhili has a strong footing and where it jostles along with Rajasthani. The Bhili-Rajasthani border marches along the Vindhya and the Satpura borders of the Agency and turns north-west passing through Jhabua, Ali-Rajpur and the hilly areas of Sailana and Ratlam before it runs into Mewar. Space forbids a detailed examination of the figures by the different areas. It will suffice to note the features of any one area. Taking Barwani, we find the Pati Tahsil which lies on the Satpuras is the stronghold of Bhili. Nearly 97 per cent. are Bhili speakers. Descending to the narrow Narbada valley below Bhili drops down to 26 per cent. Silawad which mostly lies on the Satpuras has 85 per cent. while Rajpur which lies on the plains in portions, has 55 per cent.

175. Bilingualism : General Results.—As already stated our information regarding bilingualism is based on the material obtained from column 15 of the Schedule and the results are embodied in Table XV—Part II. For the purposes of this table the five principal vernaculars of Central India, *viz.*, Eastern Hindi, Western Hindi, Rajasthani, Bhili and Gondi together with Marathi, and Gujarati which is spoken by the ubiquitous trading classes principally in western Malwa and in the Vindhyan States, were selected and the rest of the entries were ignored.

These seven languages account for 99.5 per cent. of the total population and provide us with a comprehensive view of bilingualism.

The most noticeable thing in the result is that bilingualism is very little in evidence in any of the five vernaculars of Central India as mother-tongue. Of 10,000 speakers of Eastern Hindi, 9,918 speak that language as their mother-tongue only, 67 claim to know Western Hindi, 5 Rajasthani and 10 Gondi. Only 1 per cent. of the speakers of Western Hindi claim Rajasthani as their Subsidiary language. Rajasthani is used as mother-tongue only by 96 per cent. of its speakers and 4 per cent. claim mastery over Western Hindi. Bhili speakers show only 3 per cent. of bilingualism in Rajasthani. The preponderance of the mother-tongue is therefore complete in all these languages ; bilingualism is more in evidence among the Marathi and the Gujarati speakers. Of every 10,000 persons of Marathi speakers, 3,363 use Western Hindi, 807 Rajasthani, 15 Eastern Hindi and 11 Gujarati as subsidiary. The Gujarati speakers appear to be equally bilingual. The linguistic distribution for the Agency is shown in a map which forms the frontispiece to this report and from it will be seen the practically complete absence of bilingualism in Central India, so far as the main languages of the area are concerned. One interesting sidelight to these returns deserves notice. Persons whose mother-tongue is one of the highly developed vernaculars have not hesitated to state that they also speak one of the tribal dialects, such as Bhili or Gondi, etc. The details of such speakers can be had from Subsidiary Table II. In Ali-Rajpur 17 per cent. of Gujarati speakers have returned Bhili as their subsidiary language.

For the sake of convenience the main figures for the incidence of bilingualism are set out in the following table :—

Languages.	Persons.	Incidence of bilingualism per 10,000 speakers of mother-tongue.	Languages.	Persons.	Incidence of bilingualism per 10,000 speakers of mother-tongue.
1	2	3	1	2	3
A—Gondi as mother-tongue with the following as Subsidiary.	354,098	10,000	E—Rajasthani as mother-tongue with the following as Subsidiary.	1,646,881	10,000
i. Eastern Hindi . . .	10,053	284	i. Gondi	264	2
ii. Western Hindi . . .	11,576	327	ii. Eastern Hindi . . .	226	1
iii. Rajasthani	1,432	40	iii. Western Hindi . . .	66,082	401
TOTAL SUBSIDIARY . . .	23,061	651	iv. Bhili	634	4
B—Eastern Hindi as mother-tongue with the following as Subsidiary.	1,490,431	10,000	v. Marathi	527	3
i. Gondi	2,465	10	vi. Gujarati	610	4
ii. Western Hindi . . .	16,131	67	TOTAL SUBSIDIARY . . .	68,343	415
iii. Rajasthani	1,191	5	F—Marathi as mother-tongue with the following as Subsidiary.	54,539	10,000
TOTAL SUBSIDIARY . . .	19,787	82	i. Eastern Hindi	81	15
C—Western Hindi as mother-tongue with the following as Subsidiary.	2,405,677	10,000	ii. Western Hindi . . .	18,344	3,363
i. Gondi	378	2	iii. Rajasthani	4,400	807
ii. Eastern Hindi . . .	8,345	35	iv. Gujarati	61	11
iii. Rajasthani	24,258	101	TOTAL SUBSIDIARY . . .	22,886	4,196
iv. Marathi	1,260	5	G—Gujarati as mother-tongue with the following as Subsidiary.	63,292	10,000
v. Gujarati	567	2	i. Eastern Hindi	49	8
vi. Bhili	88	..	ii. Western Hindi . . .	7,533	1,189
TOTAL SUBSIDIARY . . .	34,896	145	iii. Rajasthani	12,523	1,979
D—Bhili as mother-tongue with the following as Subsidiary.	584,014	10,000	iv. Bhili	1,739	275
i. Western Hindi	3,646	62	v. Marathi	74	12
ii. Rajasthani	17,180	294	TOTAL SUBSIDIARY . . .	21,918	3,463
iii. Gujarati	857	15			
TOTAL SUBSIDIARY . . .	21,683	371			

176. Area of bilingualism.—The low incidence of bilingualism need cause no surprise as it is conditioned by the distribution of languages in the different localities. In a homogeneous Bagheli area as in Baghelkhand, there is no need to use any other language. Thus in Rewa 99 per cent. of the Eastern Hindi speakers use it as their mother-tongue. In Maihar which has a Bundeli area to its west, only 45 per ten mille of the Eastern Hindi speakers use Western Hindi as a subsidiary language. In Bundelkhand practically none resort to a second language. Similarly 99 per cent. of the Bhils in Jhabua, Ali-Rajpur, Barwani, Ratlam and Sailana have no use for a secondary language. The same remark applies to the Rajasthani speakers in the home area. Bilingualism is a forced necessity only when the speakers are away from it. Thus the Bhil settled in the plateau in northern Malwa—in Rajgarh and Narsingharh—is highly bilingual. We can discern genuine and pronounced bilingualism only among the immigrant speakers of Marathi and Gujarati, both of whom are forced to use either Hindi or Malvi as a subsidiary language. The official language in the Maratha States is Hindi and the Marathi speakers who are mostly officials have therefore greater compulsion to use Hindi outside their home. The Gujarati uses Rajasthani or Hindi according to his needs and the prevalence of the dominant language of the locality.

177. Other features of bilingualism.—We have now examined the distribution of bilingualism and the condition under which it occurs. We have failed to see any keen struggle between the languages. On the other hand the familial language in each locality has strongly entrenched itself and the external language shows little evidence to intrude itself into the home of its rival. In each area each language maintains its own independent position so far undisturbed by the presence of a possible enemy without. The inter-action of two languages in any area gives rise to a variety of interesting problems for study. For example, we may enquire into the linguistic affinities of the two languages, the changes brought about in the phonetics and the structures of the languages by contact, and the process of adoption of the borrowed words such, for example, as the unconscious use by the Marathi speakers of many words borrowed from the surrounding languages, and such other matters. These wider linguistic problems arising out of bilingualism fortunately do not fall within the scope of this chapter. We may however briefly touch upon the question of the displacement of non-Aryan or Tribal dialects by the languages of the more advanced culture and civilization before we close this Chapter.

178. Displacement of minor languages.—Despite the presence of a large Tribal population in Central India, the question of the non-Aryan dialects giving place to the advancing tide of Aryan culture and civilization does not present itself for the very obvious reason that the process of displacement has already taken place, perhaps a long time ago. The Kol, Baiga and other Munda tribes in Rewa, the Sonr in Bundelkhand, the Saharia in northern Malwa and Gwalior, have in the present day no languages of their own. They speak the Indo-Aryan vernacular of the locality in which they reside. Whether the Bhil had a language of his own we do not know. Probably the basis of his language was Munda but his present language is thoroughly overlaid with an Aryan superstructure. We have reason to assume the contact of the Bhils with the Aryan civilization from the earliest times. Since then the process of displacement must have taken place. According to the language table, there are only two non-Aryan vernaculars with which we have any concern. These are Gondi and Korku. The Gondi (so-called) of Rewa is practically a broken Bagheli. If that be so, the Aryan language has already supplanted the language of the Gonds. The small number of Korkus who live in the villages in the Narbada valley have practically abandoned their language and speak Malvi. This is evident from the few returns shown against the number speaking the tribal language against them in Subsidiary Table III. For all practical purposes the Aryan languages have completely submerged the non-Aryan speeches in Central India. But the tribal languages of the Bhil and the Gond do not yet show signs of being displaced by the highly developed vernaculars which are the medium of culture and civilization. To obtain some measure of the displacement of the tribal dialects, it is usual to correlate the strength of the

tribe with the number of speakers of the tribal dialects. This is done in the table below :—

Name of the tribe.	Corresponding name of the Tribal dialect or language.	Strength of the tribe.		Variation per cent.	Number of speakers of Tribal language.		Variation per cent.
		1931.	1921.		1931.	1921.	
1	2	3	4	5	6	7	8
Gond	Gondi	282,397	247,486	+14.1	354,098	240,122	+47.4
Bhil	Bhili	363,124	338,137	+7.4	374,255	273,103	+37.0
Bhilala	Bhilali	193,775	169,975	+14.0	140,762	137,009	+2.7
Korku	Korku	17,815	14,881	+19.7	4,011	5,184	-22.6

It is at once apparent that the number of speakers of Gondi exceeds the strength of the Gond tribe. What has perhaps happened is that certain other tribes like Khairwar, Bharia, Majhi, Panika, etc., have also been returned as speaking Gondi. The number of Bhili speakers also exceeds the strength of the Bhil tribe. This is again due to the fact that certain other sections of the tribe who appear in Table XVII as Mankar or Patlia also have Bhili as their mother-tongue. If we however take the total strength of the Bhil group, we find that as against 684,902 persons of this group, we have 584,014 speakers of the Bhili group of dialects. They go to show that a large proportion of the Bhils are still clinging to their rude tribal language. Even the Bhilalas who are mostly Hinduised have not abandoned Bhilali. It is only the Korku who has practically abandoned his language. How long these tribal dialects will survive in their present day habitat will entirely depend on two important factors—geographical and the spread of education. The main tribal belt in the south west Vindhya and in south Rewa, is yet an undeveloped and isolated area. Means of communications are very deficient and administration which is largely decentralised, leaves the tribes more or less severely alone. Few roads and a railway line across southern Rewa will completely revolutionise the whole character of the country and are certain to bring about vast changes in the tribal population. These areas are also very backward in education and it will take some generations before it can spread and work modification in the language and thought of the primitive races. Some of these stray observations which are necessary to clothe the dry bones of Census statistics may at best serve as pointers to a study of more interesting ethnological problems. It is to the labour of the anthropologist who is primarily a field-worker that we have to look for more light and enlightenment.

SUBSIDIARY TABLE I.

Distribution of total population of each sex by mother-tongue.

Language.	TOTAL NUMBER OF SPEAKERS.				NUMBER PER 10,000 OF TOTAL POPULATION (1931).		Where chiefly spoken.
	1931.		1921.		Males.	Females.	
	Males.	Females.	Males.	Females.			
1	2	3	4	5	6	7	8
CENTRAL INDIA AGENCY	3,405,438	3,227,352	3,068,954	2,928,059	10,000	10,000	
A.—Vernaculars of India	3,402,777	3,226,013	3,065,733	2,927,016	9,992	9,996	
Austrie family	2,067	2,090	3,249	1,935	6	6	
Austro-Asiatic Sub-Family	2,067	2,090	3,249	1,935	6	6	
Munda Branch	2,067	2,090	3,249	1,935	6	6	
1. Kherwari	86	60	
2. Kurku	1,981	2,030	3,249	1,935	6	6	Indore and Rewa States. Indore, Bhopal and Dhar States.
Tibeto-Chinese Family	8	5	1	
Tibeto-Burman Sub-family	..	2	1	
Tibeto-Himalayan Branch	..	2	
Tibetan Group	..	2	
1. Bhotia of Sikkim	..	2	Rewa State.
Assam-Burmese Branch	8	3	1	
Burma Group	8	3	1	
1. Burmese	8	3	1	Indore and Chhatarpur States.
Dravidian Family	180,518	177,325	121,183	122,043	530	550	
Dravida Group	1,351	1,547	1,058	906	4	5	
1. Tamil	1,269	1,477	900	889	4	5	Indore and Rewa States. Indore State.
2. Malayalm	11	3	1	Indore, Rewa and Dhar States.
3. Kanarese	71	67	157	17	
Intermediate Group	178,698	175,400	119,436	120,686	525	544	
1. Gondi	178,698	175,400	119,436	120,686	525	544	Indore, Bhopal, Rewa and Ajaigarh.
Andhra Language	469	378	689	451	1	1	
1. Telugu	469	378	689	451	1	1	Indore and Rewa States.
Indo-European Family	3,220,184	3,046,593	2,941,300	2,803,038	9,456	9,440	
Aryan Sub-family	775	308	546	155	2	1	
Iranian Branch.	775	308	546	155	2	1	
Eastern Group	775	308	546	155	2	1	
1. Pashto	624	230	523	145	2	1	Indore and Bhopal States.
2. Balochi	151	78	23	10	Indore and Ratlam States.
Dardic Branch	24	22	8	12	
Dard Group	24	22	8	12	
1. Kashmiri	24	22	8	12	Indore, Ratlam and Sailana.
Indo-Aryan Branch	5	1	
Sanskrit Sub-Branch	5	1	
Sanskrit Group	5	1	
1. Sanskrit	5	1	Indore State.
Outer Sub-Branch	795	528	1,244	827	2	2	
North-Western Group	795	528	1,244	827	2	2	
1. Lahnda or Western Panjabi	424	243	241	181	1	1	Indore Bhopal, Narsingharh and Jaora States.
2. Sindhi	371	285	1,003	646	1	1	Indore, Dhar and Sitamau.
Southern Group	28,921	26,080	27,246	25,793	85	81	
1. Marathi	28,779	25,922	26,931	25,504	85	80	Indore, Rewa and Dhar States.
2. Konkani	142	158	315	289	..	1	Indore and Barwani States.
Eastern Group	772	704	482	304	2	2	
1. Oriya	28	3	38	43	Indore and Rewa States.
2. Bihari	318	400	34	35	1	1	Indore and Rewa.
3. Bengali	426	301	410	226	1	1	Indore, Rewa and Chhatarpur.
Mediate Sub-Branch	745,909	744,522	686,595	682,996	2,191	2,307	
Mediate Group	745,909	744,522	686,595	682,996	2,191	2,307	
1. Eastern Hindi	745,909	744,522	686,595	682,996	2,191	2,307	Indore, Rewa and Orchha.
Central Group	2,441,487	2,273,165	2,223,983	2,091,925	7,169	7,043	
1. Western Hindi	1,253,929	1,151,748	926,681	856,551	3,682	3,569	Indore, Narsingharh, Bundelkhand, and Ratlam.
2. Rajasthani	850,226	796,655	1,011,889	954,192	2,497	2,468	Indore, Rewa, Dhar and Barwani.
3. Gujarati	33,071	30,221	29,046	27,886	97	94	Indore, Dhar, Barwani, Ali-Rajpur and Ratlam.
4. Bhili (Bhil Dialects)	296,018	287,996	248,009	245,768	869	892	Indore, Ratlam, Sailana, and Jhabua.
5. Khandesi	5,402	5,278	6,328	6,675	16	16	Indore and Barwani.
6. Panjabi	2,841	1,267	2,030	853	8	4	Indore and Bhopal.
Pahari Group	267	89	193	81	1	..	
1. Central Pahari	95	37	35	6	Indore and Rewa.
2. Eastern Pahari	172	52	158	75	1	..	Indore, Ratlam, Ali-Rajpur and Barwani.
Unclassed Languages	1,229	1,175	1,003	944	4	4	
1. Gipsy Languages	1,229	1,175	1,003	944	4	4	Indore, Narsingharh, Barwani and Rewa States.

SUBSIDIARY TABLE I—concl'd.

Distribution of total population of each sex by mother-tongue—concl'd.

Language.	TOTAL NUMBER OF SPEAKERS.				NUMBER PER 10,000 OF TOTAL POPULATION (1931).		Where chiefly spoken.
	1931.		1921.		Males.	Females.	
	Males.	Females.	Males.	Females.			
1	2	3	4	5	6	7	8
B.—Vernaculars of other Asiatic Countries.	281	232	136	46	1	1	
Indo-European Family	126	90	46	19	
Aryan Sub-Family	126	90	46	19	
Eranian Branch	126	90	46	19	
Persian Group	126	90	46	19	
1. Persian	126	90	46	19	
Tibeto-Chinese Family	14	..	7	2	Indore and Bhopal.
Tai Chinese Sub-family	14	..	7	2	
Chinese Branch	14	..	7	2	
Chinese Group	14	..	7	2	
1. Chinese (Unspecified)	14	..	7	2	Indore and Orchha.
Semitic Family	135	141	83	25	1	1	
1. Arabic	135	141	83	25	1	1	Indore State.
Hamitic Family	1	
Ethiopic Group	1	
1. Somali	1	Bhopal State.
Mongolian Family	5	1	
Ural-Alatic Group	5	1	
1. Turkish	5	1	Rajgarh State.
C.—European Languages	2,380	1,107	3,085	997	7	3	
Indo-European Family	2,380	1,107	3,085	997	7	3	
Greek Group	2	..	1	
1. Greek	2	..	1	Indore State.
Romance Group	116	100	34	39	
1. French	14	37	7	26	Indore, Jhabua and Br. Pargana of Manpur.
2. Portuguese	102	63	27	13	Indore, Ratlam and Ali-Rajpur.
Celtic Group	2	5	
1. Gaelic (Scotch)	1	2	Indore State.
2. Irish	1	3	Indore State.
Teutonic Group	2,260	1,002	3,050	958	7	3	
1. English	2,257	996	3,050	954	7	3	Indore, Bhopal, Ratlam, Rewa and Chhatarpur States.
2. German	3	6	..	4	Indore and Bhopal States.

SUBSIDIARY TABLE II (Bilingualism).

Distribution by Language of the Population of each State.

States.	NUMBER PER 10,000 OF THE TOTAL POPULATION WHO SPEAK															
	GONDI AS MOTHER-TONGUE PER 10,000.								EASTERN HINDI AS MOTHER-TONGUE PER 10,000.							
	As mother-tongue only.	Eastern Hindi as Subsidiary	Western Hindi as Subsidiary.	Rajasthani as Subsidiary.	Bhili as Subsidiary.	Marathi as Subsidiary.	Gujarati as Subsidiary.	Total	As mother-tongue only.	Gondi as Subsidiary.	Western Hindi as Subsidiary.	Rajasthani as Subsidiary.	Bhili as Subsidiary.	Marathi as Subsidiary.	Gujarati as Subsidiary.	Total.
1	2	3	4	5	6	7	8	9	10	11	12	13	14	15	16	17
CENTRAL INDIA AGENCY.	9,349	234	327	40	534	9,918	10	67	5	2,247
West.																
British Pargana of Manpur.							..		2,577		6,692	787		79	..	185
Indore	4,278		5,646	76		63	5,219		3,987	793		1	..	57
<i>Bhopal Agency.</i>																
Bhopal	915	..	7,488	1,597		115	1,397		8,603	2
Khilchipur			5,216	3,784	8
Narsingharh	9,932	68		12	8,333	..	1,667	9
Rajgarh			4,591	..	682	5,227	6
<i>Malwa Agency.</i>																
Dewas States	7,143	2,857		1	6,807	..	1,510	1,683	53
Jaora			4,651	..	581	4,768	9
Ratlam			9,364	..	150	486	81
Saifana			7,200	..	133	2,667	21
Sitamau			2,000	..	2,000	6,000	2
<i>Southern Central India States Agency</i>																
Ali-Rajpur			5,862	..	3,966	..	172	6
Barwani			6,049	..	2,452	1,499	26
Dhar	9,095	905		9	5,730	..	1,615	2,839	16	25
Jhabua			4,615	..	769	4,616	2
Jobat			445	..	9,545	11
East.																
<i>Bundelkhand Agency.</i>																
Ajaigarh	7,835	..	2,165		296	9,536	..	464	80
Baoni
Bijawar			4,167	..	5,833	1
Charkhari			556	..	9,444	2
Chhatarpur			4,953	..	5,047	20
Datia			7,426	..	2,574	13
Orcha	10,000			5,405	..	4,595	1
Panna			9,813	..	187	1,194
Samthar	10,000	1
<i>Baghelkhand Agency.</i>																
Baraundha	9,366	..	248	386		226	9,166	53	781	9,558
Kothi	10,000		522	9,891	..	109	9,121
Maihar	10,000		6	9,955	..	45	7,414
Nagod	9,883	..	117	9,701
Rewa	9,693	63	2		2,088	9,916	19	65	7,766
Sohawal	9,607	154	239		139	9,675	21	304	9,353

SUBSIDIARY TABLE II (Bilingualism)—*contd.*Distribution by Language of the Population of each State—*contd.*

States.	NUMBER PER 10,000 OF THE TOTAL POPULATION WHO SPEAK															
	WESTERN HINDI AS MOTHER-TONGUE PER 10,000.								RAJASTHANI AS MOTHER-TONGUE PER 10,000.							
	As mother-tongue only.	Gondi as Subsidiary.	Eastern Hindi as Subsidiary.	Rajasthan as Subsidiary.	Bhili as Subsidiary.	Marathi as Subsidiary.	Guzarati as Subsidiary.	Total	As mother-tongue only.	Gondi as Subsidiary.	Eastern Hindi as Subsidiary.	Western Hindi as Subsidiary.	Bhili as Subsidiary.	Marathi as Subsidiary.	Guzarati as Subsidiary.	Total
1	2	3	4	5	6	7	8	9	10	11	12	13	14	15	16	17
CENTRAL INDIA AGENCY.	9,855	2	35	101	..	5	2	3,627	9,585	2	1	401	4	3	4	2,483
West.																
British Pargana of Manpur.	9,823	677	1,423	9,590	416	..	9	..	3,346
Indore	9,400	3	17	532	1	37	10	2,247	9,465	..	1	519	6	5	4	5,823
<i>Bhopal Agency.</i>																
Bhopal	9,993	2	..	4	1	9,647	3,523	12	..	6,464	..	1	..	209
Khilchipur	8,090	1,910	113	9,935	..	1	14	9,840
Narsingharh	9,640	..	6	353	1	727	9,981	19	9,136
Rajgarh	6,750	3,238	12	488	9,918	..	4	73	5	9,396
<i>Malwa Agency.</i>																
Dewas States	8,946	..	5	1,030	..	17	4	657	9,837	..	2	150	..	9	2	8,932
Jaora	9,048	940	12	1,272	9,712	..	1	285	2	8,475
Ratlam	9,966	12	..	4	18	628	9,810	185	1	1	3	6,305
Sailana	9,272	728	230	9,926	52	5	..	17	6,035
Sitamau	8,729	1,271	252	9,981	19	9,623
<i>Southern Central India States Agency.</i>																
Ali-Rajpur	9,737	13	86	..	164	228	7,436	2,478	76	..	10	276
Barwani	9,478	517	..	5	..	312	9,714	282	1	..	3	2,607
Dhar	8,423	1,541	..	11	25	708	9,642	343	7	2	6	6,148
Jhabua	9,400	504	2	2	92	379	9,478	481	23	..	18	1,190
Jobat	9,533	467	361	4,113	5,887	352
East.																
<i>Bundelkhand Agency.</i>																
Ajaigarh	9,996	..	4	9,611	5,652	4,348	3
Baoni	9,990	10	9,997
Bijawar	10,000	9,996	5,000	5,000
Charkhari	10,000	9,983
Chhatarpur	10,000	9,928	9,274	..	56	670	11
Datia	10,000	9,965	5,658	4,342	14
Orchha	9,997	3	..	9,988	2,267	7,333	400	2
Panna	10,000	8,784	292	9,708	15
Samther	9,999	1	9,983	323	9,677	9
<i>Baghelkhand Agency.</i>																
Baraundha	7,379	627	1,994	218
Kothi	9,707	..	293	175
Malhar	9,882	..	118	2,561	5,000	..	1,250	3,750	1
Nagod	5,854	..	4,132	14	291	10,000	3
Rewa	7,033	52	2,906	..	1	6	2	123	9,130	..	145	580	..	145	..	11
Sohawal	6,522	106	3,372	493	8,929	..	357	714	7

SUBSIDIARY TABLE II (Bilingualism)—*concl'd.*

Distribution by Language of the Population of each State—*concl'd.*

States.	NUMBER PER 10,000 OF THE TOTAL POPULATION WHO SPEAK								REMARKS.
	GUJARATI AS MOTHER-TONGUE PER 10,000.								
	As mother-tongue only.	Gondi as Subsidiary.	Eastern Hindi as Subsidiary.	Western Hindi as Subsidiary.	Rajasthani as Subsidiary.	Bhili as Subsidiary.	Marathi as Subsidiary.	Total.	
1	2	3	4	5	6	7	8	9	10
CENTRAL INDIA AGENCY	6,541	..	8	1,189	1,979	275	812	82	NOTE.—In three units British Pargana of Manpur, Dewas State (Junior) and Indore, persons speaking more than one subsidiary language are returned. Their numbers are as follows :— MOTHER-TONGUE. Manpur— Eastern Hindi 3 Rajasthani 2 Marathi 1 Gujarati 2 Dewas (Junior)— Western Hindi 2 Gujarati 4 Indore— Western Hindi 11 Rajasthani 20 Marathi 29 Gujarati 17 In Central India— Eastern Hindi 3 Western Hindi 13 Rajasthani 22 Marathi 30 Gujarati 23
West.									
British Pargana of Manpur	2,703	3,243	4,325	..	270	54	
Indore	5,481	1,615	2,816	32	18	225	
<i>Bhopal Agency.</i>									
Bhopal	2,744	6,939	317	5	
Khilchipur	2,124	7,876	25	
Narsinohgarh	2,127	2,956	4,917	32	
Rajgarh	529	604	8,867	20	
<i>Malwa Agency.</i>									
Dewas States	5,305	2,368	2,382	47	
Jaora	5,524	3,644	832	79	
Ratlam	8,888	619	489	..	4	238	
Sailana	742	590	2,640	..	28	101	
Sitamau	6,783	1,739	1,478	40	
<i>Southern Central India States Agency.</i>									
Ali-Rajpur	7,703	613	1	1,683	..	953	
Barwani	8,968	320	681	8	23	516	
Dhar	5,949	653	3,396	2	..	293	
Jhabua	8,772	904	324	104	
Jobat	7,000	3,000	104	
East.									
<i>Bundelkhand Agency.</i>									
Ajaigarh	
Baoni	
Bijawar	1,429	8,571	2	
Charkhari	
Chhatarpur	6,522	3,478	1	
Datia	2,000	8,000	1	
Orchha	4,694	5,306	2	
Panna	1,714	8,286	2	
Samthar	
<i>a</i> <i>Baghelkhand Agency.</i>									
Baraundha	
Kotli	8,823	1,177	6	
Maihar	9,524	476	6	
Nagod	8,824	1,176	5	
Rewa	5,347	..	2,228	2,425	1	
Sohawal	5,555	..	1,667	2,778	4	

NOTE.—The proportions of the subsidiary Languages have been calculated on the total strength of the speakers of that mother-tongue to which they are subsidiary and the figures in each column for 'total' are the proportions of the persons speaking mother-tongue to the total population.
 In cases where persons speaking more than one subsidiary language to a particular mother-tongue have been returned, the total of the proportional figures for all subsidiary languages to that mother-tongue proportionately exceeds 10,000.

SUBSIDIARY TABLE III.

Comparison of Tribe and Language Tables.

Tribe and Language.	STRENGTH OF TRIBE (TABLE XXIII).		NUMBER SPEAKING TRIBAL LANGUAGE ONLY.		NUMBER SPEAKING TRIBAL LANGUAGE AND SOME OTHER LANGUAGE.		REMARKS.	
	Males.	Females.	Males.	Females.	Males.	Females.		
1	2	3	4	5	6	7	8	
Bhil	{ Hindu . 227,644 Tribal . 119,276 }	{ 346,920 117,641 }	{ 220,341 117,641 }	{ 337,982 179,519 }	} 284,577* 277,852	11,441 10,144	* Males. Females. Bhili 186,180 188,075 Bhilali 75,905 66,166 ----- 261,185 254,241	
Bhil	{ Hindu . 73,939 Tribal . 109,666 }	{ 183,405 108,622 }	{ 70,897 108,622 }	{ 179,519 95,486 }				
Bhidala	{ Hindu . 94,926 Tribal . 3,263 }	{ 98,289 3,267 }	{ 92,219 3,267 }	{ 95,486 .. }				
Gond	{ Hindu . 103,481 Tribal . 36,474 }	{ 139,955 37,584 }	{ 104,858 37,584 }	{ 142,442 .. }	167,424	163,613	11,274 11,787	
Korku	{ Hindu . 6,229 Tribal . 2,680 }	{ 8,909 2,688 }	{ 6,238 2,688 }	{ 8,906 .. }	1,561	1,642	420 388	Bhagori 2,389 2,284 Dungari 936 922 Moghia (Baori) 488 373 Paradli 147 149 Rathavi 30,178 29,396 Wagadi 695 631 ----- 34,833 33,755 ----- 296,018 287,966

APPENDIX A.

Showing the Languages represented on the Linguistic map of Central India Agency.

States and mother-tongues.	PERSONS SPEAKING MOTHER-TONGUE.		PERSONS SPEAKING SUBSIDIARY LANGUAGES.					
	Actual No.	Per cent. of population represented.	EASTERN HINDI.		WESTERN HINDI.		RAJASTHANI.	
			Actual No.	Per cent. of mother-tongue.	Actual No.	Per cent. of mother-tongue.	Actual No.	Per cent. of mother-tongue.
1	2	3	4	5	6	7	8	9
CENTRAL INDIA AGENCY	6,373,192
Gondi	331,384	5.2
Eastern Hindi	1,478,087	23.1
Western Hindi	2,360,539	37.0
Rajasthani	1,608,640	25.2
Bhili	577,528	9.1
Gujarati	17,014	0.3
1. Rewa	1,564,185
Gondi	331,384	21.2	10,034	3.0
Eastern Hindi	1,232,801	78.8	7,998	6
2. Indore	1,214,907
Western Hindi	296,213	24.4	15,751	5.3
Rajasthani	767,683	63.2	39,845	5.2
Bhili	151,011	12.4	11,617	7.7
3. Bhopal	704,152
Western Hindi	704,152	100.0
4. Orchha	314,296
Western Hindi	314,296	100.0
5. Dhar	228,943
Western Hindi	17,225	7.5
Rajasthani	149,669	65.4	5,134	3.4
Bhili	62,049	27.1
6. Panna	211,668
Eastern Hindi	25,324	12.0
Western Hindi	186,344	88.0
7. Chhatarpur	160,100
Western Hindi	160,100	100.0
8. Datia	158,277
Western Hindi	158,277	100.0
9. Dewas (Senior and Junior)	147,506
Western Hindi	10,103	6.8
Rajasthani	137,403	93.2
10. Jhabua	138,332
Rajasthani	17,322	12.5
Bhili	121,010	87.5
11. Barwani	126,365
Rajasthani	36,789	29.1
Bhili	82,282	65.1
Gujarati	7,294	5.8
12. Rajgarh	133,325
Western Hindi	6,581	4.9
Rajasthani	126,744	95.1
13. Charkhari	120,161
Western Hindi	120,161	100.0
14. Bijawar	115,806
Western Hindi	115,806	100.0
15. Narsingharh	112,321
Western Hindi	8,281	7.4
Rajasthani	104,040	92.6
16. Raṭlam	95,614
Rajasthani	67,664	70.8
Bhili	27,950	29.2
17. Ali-Rajpur	96,195
Bhili	86,475	89.9
Gujarati	9,720	10.1
18. Jaora	97,633
Western Hindi	12,737	13.0
Rajasthani	84,896	87.0

APPENDIX A—concl'd.

Showing the Languages represented on the Linguistic map of Central India Agency—concl'd.

States and mother-tongues.	PERSONS SPEAKING MOTHER-TONGUE.		PERSONS SPEAKING SUBSIDIARY LANGUAGES.					
	Actual No.	Per cent. of population represented.	EASTERN HINDI.		WESTERN HINDI.		RAJASTHANI.	
			Actual No.	Per cent. of mother-tongue.	Actual No.	Per cent. of mother-tongue.	Actual No.	Per cent. of mother-tongue.
1	2	3	4	5	6	7	8	9
19. Ajaigarh	82,555
Western Hindi	82,555	100-0
20. Nagod	72,356
Eastern Hindi	72,356	100-0
21. Maihar	68,819
Eastern Hindi	51,147	74-3
Western Hindi	17,672	25-7
22. Khilchipur	44,855
Rajasthani	44,855	100-0
23. Sailana	33,871
Rajasthani	21,258	62-8
Bhili	12,613	37-2
24. Sitamau	27,350
Rajasthani	27,350	100-0
25. Samthar	33,250
Western Hindi	33,250	100-0
26. Rest of Bhopal Agency includ- ing Kurwai.	27,589
Western Hindi	4,622	16-8
Rajasthani	22,967	83-2
27. Rest of Southern Central India States Agency including Jobat.	34,138
Bhili	34,138	100-0
28. Rest of Bundelkhand Agency including Baoni and Khania- dhana.	104,032
Western Hindi	104,032	100-0
29. Rest of Baghelkhand Agency including Baraundha.	104,591
Eastern Hindi	96,459	92-2
Western Hindi	8,132	7-8

APPENDIX B.

Specimens of Bargundi dialect with their Tamil Equivalents.

Below are recorded some words and sentences in the Bargundi dialect from the mouth of Bargundas themselves with their Tamil equivalents.

	<i>Bargundi.</i>	<i>Tamil.</i>
1. I go.	नां पुगाके	Nāṅ pogirêṅ.
2. We go.	नांग हदनु पुगाकी	Nāngaḷ pogirôm.
3. Thou goest.	नी पुगरा	Nî pogirây.
4. You go.	नी हदनु पुगागाव	Nî po (singular) Nîngal pogurigaḷ (plural).
5. He goes.	आद पुगाक	Avan pogirâṅ.
6. They go.	आया हदनुपाक	Avargaḷ pogirârgaḷ.
7. I shall go.	नांपोगारि वंडे	Nāṅ povêṅ.
8. We shall go.	हदनु पीगरीम	Nāngaḷ povôm.
9. Thou shalt go.	नी पोगरा वडे	Nî povây.
10. You shall go.	हपनु पीगरां	Nîngal povîrgaḷ.
11. They shall go.	हदनु पीगरों	Avargaḷ povârgaḷ.
12. He shall go.	वंडे पुगर	Avan povân.
13. I went.	ना पीहने	Nāṅ ponêṅ.
14. We went.	नांग पोयनीम	Nāngaḷ ponôm.
15. Thou wentest.	नी पोयना	Nî ponay.
16. You went.	नांग पोयनांग	Nîngal ponîrgaḷ.
17. He went.	आद पोयदीस	Avan ponân.
18. They went.	आया पीहसु	Avargaḷ ponârgaḷ.
19. Speak.	पेश	Pêsu.
20. Sit.	कीचबुक	Ukkâr.
21. Beat.	अदी	Aḍi.
22. I sit on a horse.	कीदर मेले कीचरु	Nāṅ Kudiraimêl uṭkârugirêṅ.
23. He sits under a tree.	अदसेड उडचे कीचबुक	Avan marattu aḍiyil uṭkârugirâṅ.
24. Policeman has caught a thief.	उलशेद तीरुडेकी पीडची	Polêskâraṅ tiruḍanai piḍittiruk- kirân.
25. The house has caught fire.	उडकी नीरपु बुदीस	Viṭtil nerruppu viḷuṅdadu.
26. A child has fallen into a well.	बोंड गोट गंडरकी उदीस	Kuḷāṅdai kiṅarṅil viḷuṅdiruk- kiradu.
27. Put mangoes into the basket.	मांगाय बीटकी वचहु	Kuḍaiyil mâmpaḷam vai.
28. The dog barks.	नाहकोल चाक	Nâi kulaikkiradu.
29. Kill the hen.	कोजकी खंड पीडुंग	Kôliyai kol.
30. Cook flesh and eat it.	करौ पुजुंगो पीम तीनगं	Karīyai samaittu śappiḍu.

APPENDIX B—*contd.*

	<i>Bargundi.</i>	<i>Tamil.</i>
31. Water.	तनी	Nir.
32. Air.	कास	Kâttu.
33. Fire.	नीरप	Neruppu.
34. Earth.	तर	Maṇ ; tarai.
35. Red.	राता	Śivappu.
36. White.	वाले	Vellai.
37. One.	ओडं	Oṇṇu.
38. Two.	इरैड	Iraṇḍu.
39. Three.	मूड	Mûṇṇu.
40. Four.	नाळ	Nâṅgu.
41. Five.	आंज	Aiṇḍu.
42. Six.	आर	Âṇu.
43. Seven.	येग	Êḷu.
44. Eight.	रुट	Etṭu.
45. Nine.	ओम्बज	Oṇbadu.
46. Ten.	पत	Pattu.
47. Eleven.	पदओड	Padinoṇṇu.
48. Twelve.	पंडरुंड	Panṇiraṇḍu.
49. Thirty.	सुरत	Muppadu.
50. Forty.	नालीद	Nârpadu.
51. Nose.	मुक	Mûkku.
52. Eac.	साई	Kâdu.
53. Breast.	नेंज	Mârbu
54. Leg.	काल	Kâl.
55. Arm.	के	Kai.
56. Stomach.	वरग	Vayir.
57. Wood.	रुग	Maram.
58. Iron.	इरम	Irumbu.
59. Brass.	पीतल	Pittalai.
60. Donkey.	केद	Kaḷudai.
61. Tiger.	पुल	Puli.
62. Monkey.	बान्दरी	Kuraṅgu.
63. Bird.	फरी, जनावर	Paravai.
64. Crow.	कागली	Kâkkai.
65. Coat.	आंगड	Śokkâyi.
66. Pagri.	तखवाट	Talaippâgu.
67. Sword.	आइद	Val.

APPENDIX B—concl'd.

	<i>Bargundi.</i>	<i>Tamil.</i>
68. Knife.	चक	Katti.
69. Pulse.	वेड	Paruppu.
70. Sugar	खाड	Sákkarai.
71. Milk.	पाल	Pál.
72. How many children have you got.	तिने अदन करका अदन श्रीरु	Uṇakku ettanai kuḷandai.
73. She cries.	अद अंगाशी	Avaḷ aḷugirâl.
74. The moon is full.	नेला पुरावलसी	Muḷu nilâ.
75. He laughs	अद्दी सीरचा	Avan Śirikkirân.
76. This is a wheat field.	इदगोदने कीलसी	Adu gôdumai vayal.
77. That is a cotton field.	अदफेदते कीलची	Idu parutti vayal.
78. God.	दंबर	Kaḍavuḷ.
79. Heaven.	मेलक	Param.
80. Hell.	नरक	Narkam (Sanskrit), Kêḷ (classic Tamil).
81. Good girl	वीचके लखीसी	Nallappen.
82. Bad woman.	कुलजामारा नाराक	Keṭṭavaḷ.
83. Stick.	कड़काल	Kól.
84. Basket.	मावुच	Kúḍai.
85. Bamboo.	बासकील	Mûngil.
86. Beggar.	कोडकी तोंगार	Piṇcaikkâran.
87. Woman.	कुलजामारा	Peṇ.
88. Uncle.	काकौ	Mâman.
89. Aunt.	काका	Attai.
90. Sister.	तंगच	Uḍaṇ piṇḍavaḷ.
91. Brother.	तेम	Uḍaṇ piṇḍavaṇ.
92. Mother.	गम	Tây.
93. Father.	गाव	Tagappan.
94. Father-in-law.	अमान	Mâmanâr.
95. Mother-in-law.	अत	Mâmiyâr
96. Son.	चोक	Magan.
97. Daughter.	पोच वर	Magaḷ.
98. King.	राजा	Araśu.
99. Queen.	राणीबाट	Râṇi.
100. I see a snake on the ground.	तरसेल पांस पाते	Nilattiṇ mēl pāmbai ppârkirēṇ.
101. When will you eat.	पर्ये तोंगार	Eppoludu śappaḍu girây.
102. What will you drink.	ने कुडचरा	Eṇna kudippây.
103. Which girl is good looking.	लखी पोचकडो यतनेसी	Eṇḍa peṇ nalla aḷagu.

APPENDIX C.

Rajasthani-Bhili Linguistic Border Zone.

Detailed Language Statistics by Tahsils for certain States in the Bhili speaking areas.

State and Tahsils	Total Population.	BHILI.		RAJASTHANI.		GUJARATI.		WESTERN HINDI.		OTHER LANGUAGES.		REMARKS.
		Absolute strength.	Proportion per cent.	Absolute strength.	Proportion per cent.	Absolute strength.	Proportion per cent.	Absolute strength.	Proportion per cent.	Absolute strength.	Proportion per cent.	
1	2	3	4	5	6	7	8	9	10	11	12	13
Ratlam State	107,321	27,950	26.0	67,664	63.1	2,553	2.4	6,744	6.3	2,410	2.2	All Religions.
1. Ratlam City	37,075	229	0.6	26,648	70.7	2,390	6.3	6,319	16.8	2,089	5.6	Do.
2. Malvi khalsa (Ratlam Tahsil)	26,522	119	0.4	19,586	73.8	16	0.1	220	0.8	104	0.3	Hindu.
3. Bajna Tahsil	13,631	12,839	94.2	460	3.4	3	12	0.1	Hindu and Tribal.
4. Jagirs	29,493	28	0.1	15,680	53.2	77	0.3	31	0.1	178	0.6	Hindu.
Sailana State	35,223	12,613	35.8	21,258	60.4	356	1.0	810	2.3	186	0.5	All Religions.
1. Bangrod Tahsil	7,985	837	10.5	6,369	79.8	24	0.3	31	0.4	81	1.0	Hindu and Tribal.
2. Bilpalk Tahsil	8,936	1,947	21.8	6,369	71.3	152	1.7	10	0.1	Do.
3. Raoti Tahsil	9,762	8,196	83.9	1,503	33.3	32	0.3	13	0.1	17	0.2	Do.
4. Sailana Tahsil	8,540	1,601	18.7	5,382	63.0	64	0.7	145	1.7	62	0.7	Do.
Ali-Rajpur State	101,963	86,475	84.8	2,809	2.8	9,720	9.5	2,323	2.3	636	0.6	All Religions.
1. Bhabra Tahsil	26,933	18,845	70.0	181	0.7	7,256	26.9	111	0.4	19	0.1	Hindu.
2. Chandpur Tahsil	11,146	10,570	94.8	41	0.4	72	0.6	51	0.3	Do.
3. Chhakatala Tahsil	11,462	10,902	95.1	27	0.2	400	3.5	1	..	22	0.1	Do.
4. Nanpur Tahsil	10,854	9,015	83.1	588	5.4	98	0.9	30	0.3	Do.
5. Rath Tahsil	41,568	35,199	84.7	1,662	4.0	1,454	3.5	420	1.0	591	1.4	Do.
Barwani State	141,110	82,282	58.3	36,789	26.1	7,294	5.2	4,409	3.1	10,336	7.3	All Religions.
1. Anjar Pargana	39,780	10,374	26.1	21,658	54.4	4,277	10.8	2,241	5.6	778	1.9	Hindu, Muslim and Tribal.
2. Pansemal Pargana	35,270	22,030	62.5	1,404	4.2	1,348	3.8	158	0.4	8,740	24.8	Hindu.
3. Pati Pargana	14,277	13,841	96.9	285	2.0	85	0.6	12	0.1	24	0.2	Hindu and Tribal
4. Rajpur Pargana	28,613	15,681	54.8	9,730	34.0	1,101	3.8	107	0.4	506	1.8	Hindu.
5. Silwad Pargana	23,170	19,607	84.6	2,383	10.3	251	1.1	34	0.1	66	0.3	Do.
Jhabua State	145,522	121,010	83.2	17,322	11.9	1,515	1.0	5,517	3.8	158	0.1	All Religions.
1. Jhabua Tahsil	30,721	26,879	87.5	1,009	3.3	129	0.4	1,547	5.0	15	..	Hindu and Tribal.
2. Rambhapur Tahsil	10,361	8,306	80.2	1,487	14.4	133	1.3	112	1.0	7	..	Do.
3. Ranapur Tahsil	32,379	28,669	88.5	1,990	6.1	85	0.3	682	6.1	9	..	Do.
4. Thandla Tahsil	22,956	18,552	80.8	1,305	5.7	212	0.9	826	3.6	31	0.1	Do.
5. Umrao Areas and Minor Jagirs.	49,105	37,416	76.2	9,244	18.8	400	0.8	432	0.9	96	0.2	Do.
Indore State
1. Nimad District	464,263	133,665	28.8	242,851	52.3	19,645	4.3	47,475	10.2	20,627	4.4	All Religions.
Barwaha Pargana	56,817	863	1.5	39,460	69.5	566	1.0	13,524	23.8	2,404	4.2	Do.
Bhikangaon Pargana	62,632	13,789	22.6	40,472	64.6	120	0.2	5,504	8.8	2,747	4.4	Do.
Kasrawad Pargana	42,730	2,243	5.3	36,773	86.1	695	1.6	2,486	5.8	533	1.2	Do.
Khargone Pargana	83,331	11,954	14.4	48,931	58.7	6,792	8.2	12,086	14.5	3,568	4.2	Do.
Maheshwar Pargana	46,667	5,425	11.6	34,468	73.9	340	0.7	5,141	11.0	1,293	2.8	Do.
Nisarapur Pargana	56,973	36,425	63.9	12,773	22.4	4,199	7.4	2,437	4.3	1,139	2.0	Do.
Segaon Pargana	59,670	22,970	38.5	26,660	44.7	4,930	8.2	3,263	5.5	1,847	3.1	Do.
Sendhwa Pargana	55,443	39,906	72.1	3,314	6.0	2,003	3.6	3,034	5.5	7,096	12.8	Do.

NOTE.—Figures in columns 3 to 12 are for the Religions shown in the remarks column

CHAPTER XI

Religion.

179. **Statistical reference.**—Imperial Table XVI gives statistics for all religions and the fly-leaf to it gives figures for Christians by sect, *viz.*, Roman Catholics, Romo Syrians, other Syrians and others. Imperial Table XIX exhibits figures for European and allied races and Anglo-Indians by Race and Age. The following Subsidiary Tables will be found at the end of the Chapter :—

- I.—General distribution of the population by Religion.
- II.—Distribution by States of the main religions.
- III.—Christians—Number and variation.
- IV.—Religions of Urban and Rural population.

180. **The basis of the figures.**—The information regarding religion was recorded in column 4 of the General Schedule. On the Enumeration Cover the following instructions were given :—

Column 4 (Religion).—Enter here the religion which each person returns, as Hindu, Muslim, Sikh, Jain, Arya, Brahmo, Dev Samaj, Christian, Zoroastrian. In the case of Christians and Jains the sect also should be entered below the religion, such as, Roman Catholic Christian, Presbyterian Christian, Swetambari Jain, Digambari Jain, etc. In the case of aboriginal tribes who are not Hindu, Muslim, Christian, etc., the name of the tribe should be entered in this column, *e.g.*, Bhil, Gond, Korku, etc.

These were amplified by the detailed instructions given in the Agency Code :—

- (7) The answer which each person gives about his religion must be accepted and entered in column 4, but care must be taken not to enter Jains and Sikhs as Hindus. If a man says that he is a Jain or a Sikh, he should be entered as such, even though he also says that he is a Hindu. Some Jains consider that they are Hindus, and others do not ; but what we want to ascertain at the Census is the total number of Jains, and this we cannot do if some of them are entered under the general head "Hindu". Similarly, Brahmos, Aryas and Dev Samaj should be recorded as such, and not as Hindus.

NOTE.—The enumerator should not ask an illiterate person "what is your religion?" but "Are you Muslim, Hindu, Sikh, Jain, Buddhist or Christian, etc.?" Ignorant persons often give the name of their caste when asked their religion but in the case of the tribes which are neither Hindu nor Muslim the answer given under "Religion" will frequently be the same as that under caste, and correctly so, as their religion will be put down as "Tribal".

Great care should be taken to get a correct return of Christian sects, in column 4 and to eliminate vague entries such as Protestant. Usually there are only one or two missions at work in a State and local missionaries have been requested to give the requisite instructions to members of their community as to the way in which the adherents of each mission are to be entered.

NOTE.—In the case of Christians belonging to definite tribes or races the term "Indian Christian" should not be entered in column 8 but the tribe to which the individual belongs.

In accordance with the orders of the Census Commissioner that the terms Sikh and Hindu are mutually exclusive for Census purposes, the enumerating agency was instructed to call upon a Sikh to specify definitely under which heading he wished to be enumerated, *i.e.*, whether Sikh or Hindu. With one exception, generally there was no difficulty in securing the returns for *dharma* or religion though occasionally there was a tendency to confuse columns 4 and 8 of the Schedule. The exception mentioned relates to the returns of Tribal religion which will be noticed further below. The returns obtained on these instructions show that out of the 66 hundred thousand and odd people enumerated there is not one single person who could not be assigned under any of the categories shown in Imperial Table XVI. So far as the Census is concerned we have been able to assign each person to a definite religious communal group to which the enu-

merated claims to belong. Save for the possible idiosyncrasy of the enumerator in some instances, the answer which each person gave was accepted and there was no further inquisition about his belief or disbelief. There was no attempt either to lay down any minimum definition of religion or to find out whether the person conformed to that. The doctrinal, philosophical or ethical aspects of religion are after all matters of individual concern. From whatever point of view or outlook a person has framed his answer we accept his statement and group him under the appropriate label.

181. The meaning of figures.—For the interpretation of our statistics, it is necessary to know something of the various religious labels with which we will be dealing. The religion table contains 9 of them. Some of them—Muslim, Christian and Zoroastrian—are sufficiently clear cut and mutually exclusive to have a distinct and definable identity though on the fringes of the first two there are communities whose beliefs shade into each other. Thus the Naytas of Malwa share in equal degree the Muslim and Hindu religious beliefs and certain Christianised communities have for their religious back-ground a strong tinge of non-Christian beliefs and practices. But we strike at a certain amount of indefiniteness when we come to consider the religion of the great majority of people who have returned themselves as Hindu and of that ever dwindling number who have styled themselves as Tribal. The inter-action between these two systems has been slow, persistent and coeval with the growth of religion in India that makes it impossible to say even now where the primitive religion ends and where the higher religion begins. The earliest religious stratum is the primitive religion of the hill tribes and to adopt Tylor's imperfect but, nevertheless useful definition it may be described as the 'belief in supernatural'. On this has been superimposed, vast complex and heterogeneous customs, beliefs and social organisation and the whole compounded is labelled as Hinduism. Into its fold have been swept the primitive thought of all but those who still hold out a dubious position on the thin vanishing dividing line, the belief of the Chamar and the Balai, of the criminal and the degraded tribes, of the proud Rajput, of the Brahman who has given up his sacerdotal functions and taken to the plough and menial service and of the ascetic who holds communion with the One on the banks of the sacred Narbada. In the words of a recent writer 'it has developed by taking' the primitive beliefs 'into its articles, speculating freely in its own way, learning much and unlearning nothing. It has undergone never ceasing changes and is still unchanged'.

182. Religion as a basis of statistical classification.—Now the figures for various religions which we have recorded have their intrinsic interest or merit, from administrative or sociological point of view. In Census statistics they occupy an important position not only as a main factor in Table XVI but as a cross factor in Age, Sex, Civil Condition, Literacy and the growth and distribution of population. They in fact form the chief basis of classification of our statistics. The value of such a classification has been impugned on the grounds that whatever homogeneity of race, tradition and custom may have been connoted by the term Hindu, Muslim, Christian, etc., in the past has ceased to exist to a sufficient degree to influence the statistics. It is argued that so far as customs of demological importance are concerned, *e.g.*, early marriage, seclusion of women, treatment of children, etc., the divisions of real significance are not vertical sections of society by difference of religion but horizontal divisions into strata differentiated from one another by social and economic conditions.

Primâ facie it may appear unreal though not unsound to base classification because a group of persons happen to share a common belief or persons happen to be born into such communal groups, ignoring the fact of what they do or how they influence by occupation the social structure in which they have their being. But such a contention takes no account of the fact that religion is still a dynamic factor in the life of the people, colouring not merely their spiritual but intensely worldly activities as well. A demographer does not invent classification. He usually seizes hold of existing ones. Once religion becomes a matter of individual concern and ceases to dominate the sociological outlook of the communal groups and society is freed from the thralldom of pernicious customs imposed on it in the name of religion, classifications based on religion will lose their present force and meaning. The real division of society will then be not into groups of

those who worship different Gods or whose religious quest after Gods differs but into those who follow different occupational paths in their worldly life.

At present even if religion be a living force, would it not be advisable to replace it by caste, race or occupation? Caste in the first instance excludes non-Hindus. Secondly it is too complicated a structure to lend itself to easy statistical classification? Thirdly opinion is gathering round the idea that caste itself should disappear from the Census as it is thought—though not logically—that caste distinctions are perpetuated by decennial Censuses. As regards race in an anthropological and scientific as opposed to popular sense, it is a very elusive basis owing to the insufficient and defective knowledge of the racial history of man in India. It is much easier and ever so accurate to label the religions but to divide the population on a racial basis is at present well-nigh impossible. In Central India the problem of race bristles with difficulties. There are the primitive tribes—Gond, Kol, Baiga and Bhil, etc.—whose racial affinity *inter se* as well as their affinity with the population of the plains is not well-established. Some of the lower elements in the plain population have distinct affinity with the hill tribes. In the ethnology map of India which Risley published in the ethnographic appendices to the India Report of 1901, he showed that part of Central India lying to the west of Indore as Scytho-Dravidian and the eastern half as Dravidian. Brahmans, Rajputs and many others would insist on being classed as Aryans (whatever that may mean). Race cannot form any adequate basis, till our ethnic labels are reinterpreted and even rearranged, more accurate light is thrown on early racial history and the hysterics of panegyrists give place to sober statement of facts relating to racial and cultural history.

To come to occupation. The population of Central India may broadly be divided into masses and a small ruling class at the top. The latter is composed of the indigenous aristocracy including every kind of salvage from the wreck of a feudal society. It may appear strange to state that there is no real middle class here which has arisen elsewhere in other parts of India. The masses live on land and follow agriculture. On what basis can this population be divided? Land tenure varies from one place to another so much that it is difficult to summarise it at one place. Moreover it is doubtful whether agricultural tenures influence sociological data. Further agriculture as at present practised admits of little variety and differentiation. The absence of industries and real urban areas again keeps down differentiation in occupation. When economic life is organised on different grades of work, such as industrial and factory labour, skilled and unskilled work, rural and urban labour, transportation, etc., statistics obtained on the basis of occupation and by regional groups are worth a great deal from the sociological point of view. Society has not yet become broad-based on a purely economic basis. It is divided into narrow sectional groups and is still rooted in custom, tradition and its complex social organisation and so far as Central India is concerned, there is yet no sign it is moving away from its moorings.

183. General distribution.—The general distribution of the total population by religion at this and the last Census together with the variation is shown

Religious Distribution and Net Variation.

Religion.	NUMBER IN		Net variation.
	1931.	1921.	
I	2	3	4
1. Hindu	5,852,204	5,210,721	+641,483
(a) Brahmanic	5,848,519	5,210,120	+638,399
(b) Arya	3,097	529	+2,568
(c) Brahmo	66	72	-6
(d) Others	522
2. Jain	50,268	44,431	+5,837
3. Sikh	1,426	827	+599
4. Buddhist	13	10	+3
5. Muslim	376,637	331,520	+45,117
6. Christian	10,476	9,062	+1,414
7. Zoroastrian	976	950	+26
8. Jew	38	29	+9
9. Tribal	340,752	309,469	-58,717
10. Indefinite	4	-4

in the marginal table. The Hindus form 88 per cent. of the total population. After a long interval come the Muslims who form 5·6 per cent. and they are closely followed by the Tribal religion which forms 5·1 per cent. of the population. The remaining religions claim for their adherents a little over one per cent. The entire population is practically distributed among these three religions. With the exception of Jain religion which has just over 50 thousand and the Christians who number a little over 10 thousand none of the

remaining religions have more than 5,000 adherents. Out of every 10 thousand of

RELATIVE INCREASE OR DECREASE OF THE DIFFERENT MAIN RELIGIONS
AS SHOWN BY THE CURVES OF THE LOGS OF THE POPULATION
IN EACH RELIGION 1911 - 1931.

TOTAL POPULATION ———— MUSLIM ———→
HINDU - - - - - TRIBAL ○—○—○

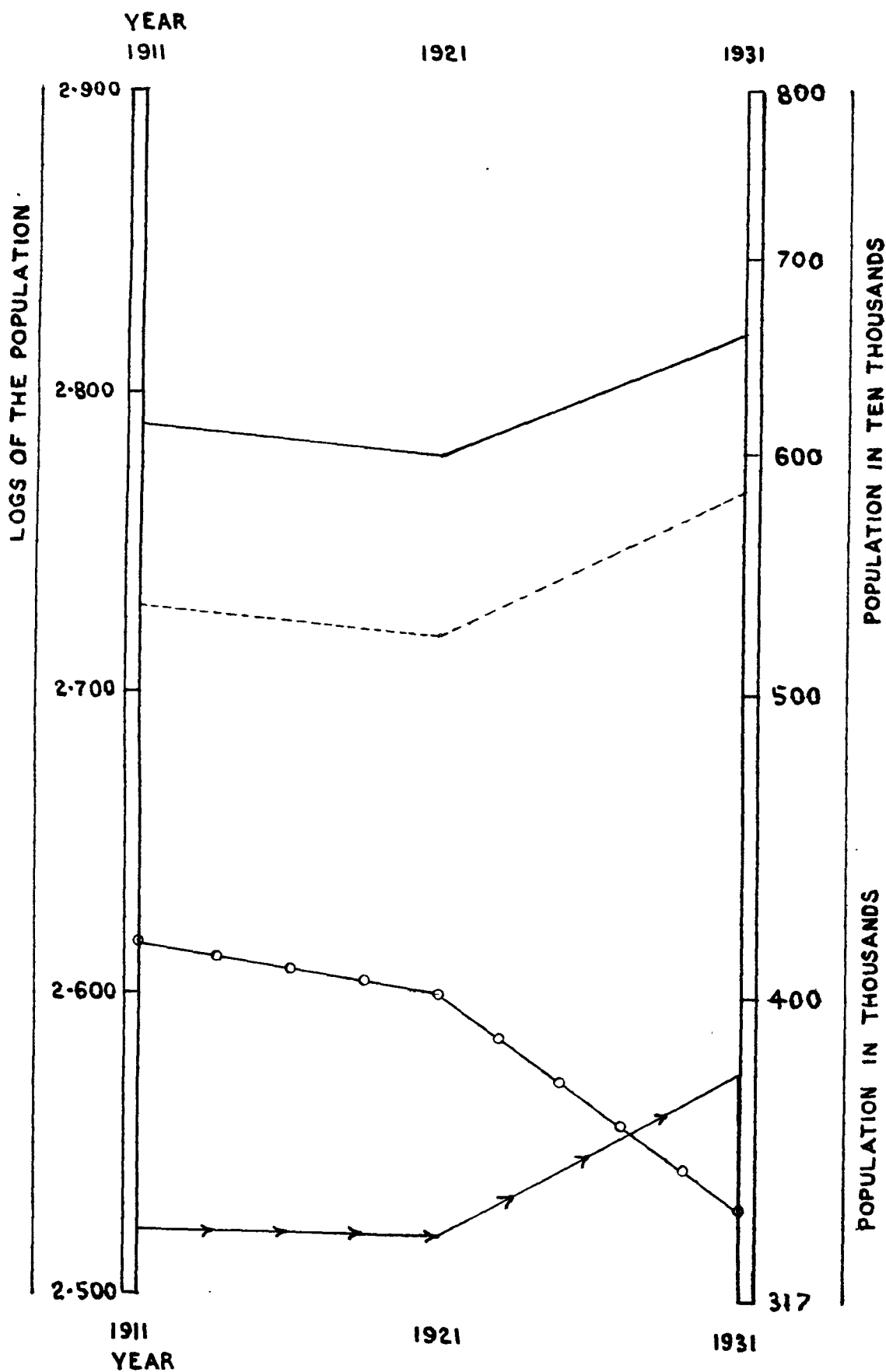

the population 8,817 are Hindus, 568 Muslims, 514 Tribals, 76 Jains, 16 Christians and 9 others.

184. **Variation.**—Subsidiary Table I gives the variation per cent. for the decade as well as the net variation per cent. from 1911-1931. The marginal table

Proportional Variation in the Main Religions.

Religion.	VARIATION PER CENT. INCREASE (+) DE- CREASE (—).		Net variation per cent. 1911-1931.
	1921-1931.	1911-1921.	
Hindu	+12.1	—2.2	+9.7
Muslim	+13.4	— .7	+13.0
Tribal	—14.7	—3.3	—17.5
Jain	+12.9	—6.6	+5.3
Christian	+15.6	+18.1	+36.5
Others	+153.5	+20.6	+200.3

sets out the relevant figures from it. The Tribal figures alone show an abnormal fall. The rest show a very satisfactory rise and all of them have recovered from the adverse effects of the previous decade making good the loss they had previously sustained. The variation in the main religions is graphically illustrated in the diagram.

185. **Local distribution.**—In the West the proportion of Hindus to the total population is 81.7 per cent. and that of the Muslims and the Tribals is 8.4 per cent. each. In the East the Hindus preponderate overwhelmingly. The proportion is as high as 95.9 per cent., i.e., 14 per cent. more than that of West. The Muslim and Tribal proportions drop down to 2.7 per cent. and 1.4 per cent. respectively. The local distribution of each religion will be noticed separately when we

Religious Distribution in the Natural Divisions.

Natural Division.	PER 10,000.					
	Hindu.	Muslim.	Tribal.	Jain.	Chris- tian.	Others.
1	2	3	4	5	6	7
West	8,165	837	847	108	28	15
East	9,541	270	146	38	2	3

come to deal with them individually. Here we see the great difference between the West and the East. Out of the 9 religions recorded 4 may be left out of account as they present no interesting features. The Jews and the Buddhists represent some stray people caught in the Census net. The Zoroastrians represent a small colony of settlers in the civil and military stations following trade and some are State employees. The Sikhs are mainly found in military employment in few States. The Zoroastrians and the Sikhs are mainly found in the West. The Jains are concentrated in the West which is more progressive in trade and commerce. As will be seen further on the Muslims held sway in Malwa for about six centuries. The activities of the missions, railway and military garrison Stations are all concentrated in the West. So is the Tribal population spread more in the southern portions of the West than in the hills of the East.

186. **Hindu.**—The instructions tell us to be wisely discreet in reviving the familiar question 'who is a Hindu'. The previous Census Reports contain a full, interesting but inconclusive discussion as to what constitutes Hinduism. The method of exclusion adopted in 1891 by Sir A. Baines has the merit of being practical and readily understandable. Hinduism was defined as "the large residuum that is not Sikh or Jain, or Buddhist or professedly animistic or included in one of the foreign religions such as Islam, Mazdaism, Christianity or Hebraism".¹ In the 1921 India Report Mr. Marten gave a definition of Hindu as adopted by the All-India Hindu Mahasabha :— "Hindu means any person professing to be a Hindu or following any religion of Indian origin and includes Sanatanists, Aryasamajists, Jains, Sikhs, Buddhists and Brahmos". A general discussion on this question belongs to the region of polemics rather than to Census proper.

The term 'Brahmanic Hindu' used in the religion table requires some amplification. It consists of diverse elements. Firstly there are the Hinduised tribes who by some kind of prescriptive right have become Hindus like the Bhil, Bhilala, Kol, Gond and other primitive tribes. In each intercensal period there is an accretion to the Hindu fold from the tribal rank. At the time of the Census there is the Census enumerator who converts the primitive tribes and elevates

¹ Quoted in *India Report*, 1901, para. 628.

them in no time and with little effort. Secondly come the Chamar, the Balai, the Basor and other depressed classes forming the base of the Hindu social pyramid in number exceeding either the Brahman or the Rajput in Central India. Thirdly there are those semi-tribal, semi-Hinduised groups like the Banjara, Moghia, Sansi, Bahelia, etc., caught in the currents of Hinduism, with neither a fixed abode nor a definite place in the social structure. Between all these and the higher classes at the apex lie a vast number of groups, pure and impure in varying degrees, acquiescent and contented with their lot in life and sharing

Caste Composition of the Hindu Population.

Caste.	Percent- age to Hindu popula- tion.	Percent- age to total popula- tion.
1	2	3
Depressed castes . . .	13.5	12.0
Hinduised tribal castes . . .	16.6	15.0
Upper castes (Brahman, Bania and Rajput).	19.4	17.3
Rest	50.5	44.7

every shade of religious beliefs. It need not be supposed that the Brahman or the Rajput always lives in a rarified atmosphere of a high transcendental religion. In fact Gods are peculiarly interchangeable. It is not unseemly for a Rajput, a Brahman or a Bania in Bundelkhand to offer worship at a *chabutra* of Hardaul. What matters is the social gradation and in that the top few have their privileges by right and the vast mass below by sufferance or toleration. The problem whether they are Hindus or not does not worry them for their social conscience has not yet been stirred. At present it only troubles a doubting Census Official and the writer of the Census Report. The marginal statement compiled from the caste table gives an idea as to the composition of the Hindus. This internal structure of the 'Brahmanic Hindu' is to be carefully noted and borne in mind when the figures for Hindus are used in other Chapters.

187. **Distribution.**—The distribution of the Hindu population by States is set out in the map. In as many as 19 States they form over 90 per cent. of the population. In the two Muslim States of Jaora and Bhopal they form 80 per cent. In the States of Sailana and Ratlam where Tribal returns persist the proportion of the Hindus falls to 56 per cent. Their lowest strength is in the State of Jhabua where it is only 16 per cent.

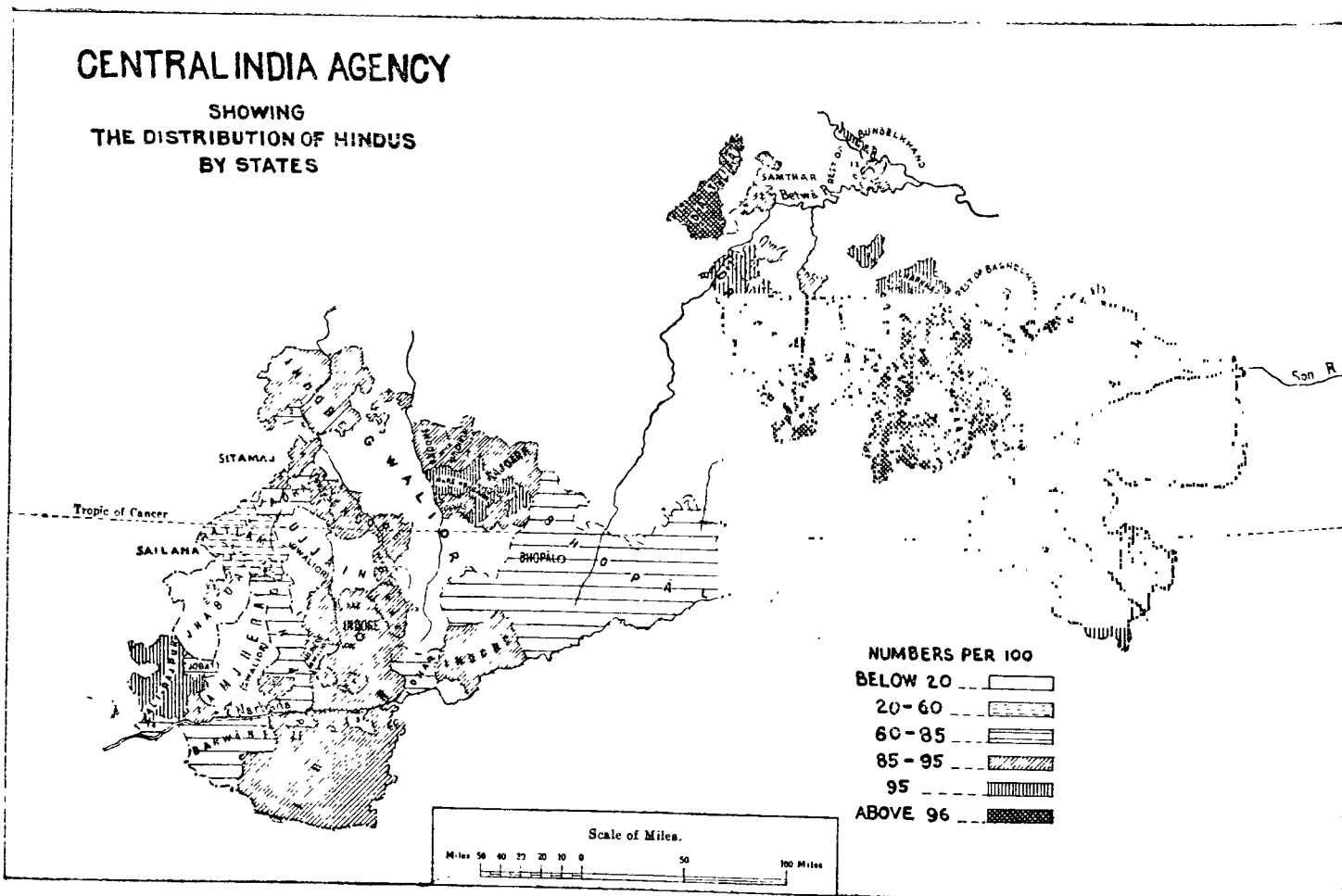

In the decade the Hindus have increased by 12.1 per cent. In the previous decade there was a decrease of 2.2 per cent. The growth of this population is due to natural causes and to the accretion from the Tribal rank as well as due to the classification of Tribals as Hindus. In Central India the Hindus do not lose to Muslims or to Christians or Aryasamajists. Conversion as a factor in variation is negligible. The Hindus gain invariably from the Tribal population and the diagram brings out the same. Migration has very little effect on our figures.

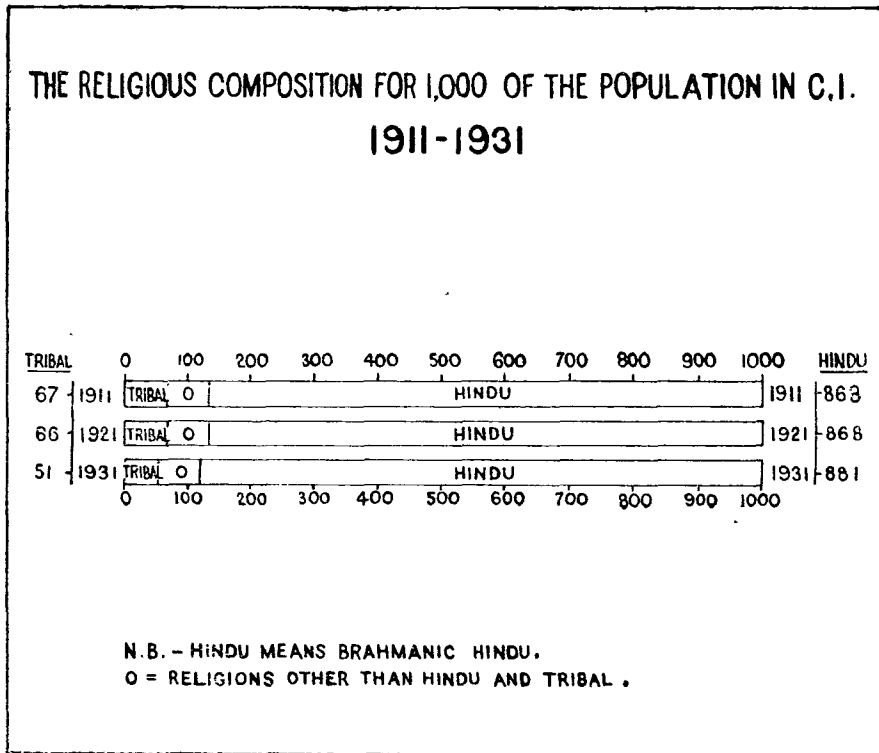

188. **Tribal.**—The last Agency report stated : ‘ The classification “ Animist ” has never been satisfactory and it would be much better if it were to disappear altogether. It is never possible to say where the Animist begins and the Hindu ends. Any close consideration of these figures would therefore be waste of time.’ The term Animist has been replaced by Tribal but the classification has not disappeared. The classification is no doubt unsatisfactory. Owing to the inherent defect in the manner in which the returns are secured the figures are rendered inutile if not completely worthless. Nevertheless they are in a sense a useful guide in the study of a group of tribes, who however much they might coquet with the higher civilization of the plains with which they are now being brought into immediate and close contact still have their being in their primitive thought and even social organisation, though atrophied and overlaid everywhere with the cults and rituals of Hinduism. For our purposes they retain sufficient identity though its sharpness may be blurred. From Census to Census the tribal and ethnic belts are dwindling but not at such rate or in such a way as the figures would have us believe. Their concentration in some of the remoter places is of interest and also of importance administratively. In recent times the conservation of primitive races and their protection from disintegration and decay are no less a pressing need and a responsible charge on the more advanced races. From these points of view our figures have some value though from a purely demographic point of view their value may be called in question.

The last sentence of the instruction on the Cover read : In the case of aboriginal tribes who are not Hindu, Muslim, Christian, etc., the name of the tribe should be entered in this column, *e.g.*, Bhil, Gond, Korku, etc. A member of any tribal group who did not claim to belong to any of the recognised religious faiths was considered as professing the Tribal religion. But this does not free us from our difficulties in elucidating the precise meaning of this religious label.

Much research has been done into the religious beliefs of primitive tribes and our knowledge of animism has been much widened. “ Primitive religion on fuller investigation than was possible in Tylor’s time turns out to comprise many types of divine beings that the savage does

not bring under one idea at all unless it is simply that of being divine, that is to say worshipful ; his consciousness of their being worshipful growing out of the very fact that he worships them by impulse precipitated in custom. Thus the Tylorian animism hardly provides a basis for primitive religion but at most will serve as a key to primitive theology. Undoubtedly when religion has reached the stage of trying to put its ideas into order, a certain uniformity of doctrine is obtained by assuming a hierarchy of spiritual beings, gods and godlings, demons and fairies, goblins and ghosts, all of which are supposed to have enough in common in respect to their nature to be dealt with by man by methods no less fundamentally alike."¹

The Gonds of south Rewa worship *Bada Deo*, *Baghaut* (one killed by the tiger) and the spirit of *Hardaul*—a Bundela Rajput of Orchha. The last is worshipped in order to assuage his wrath for if he is enraged he causes illness. Ancestor worship is also strong in them. When an elderly member of a family dies a separate platform is erected in his honour. On the third or the tenth day after cremation, the relatives and other village folk go to the place where the body was burnt and request the spirit of the dead in the following terms " Why do you reside alone in this forest. Come to your house and live with your children and relatives ". On hearing this the deceased is supposed to take the form of a ghost. He accedes to their request and goes home. In his name some quantity of wine is poured on to the earth. Hens are offered for sacrifice and cocoanuts are presented. In times of distress and difficulties, worship is offered at the platform where the spirit is supposed to reside. It is also believed that this family deity causes destruction and disease if not propitiated. *Baghaut* is supposed to protect fields and cattle.

The Bhil who has been long in contact with Hinduism, has a sufficiently large pantheon. He has appropriated the Hindu gods like *Ganesh* and *Hanuman* but offers worship to a medley of a host of others like the Cholera goddess, the Small-pox goddess, Wood-land and Forest deities and grove and mountain gods.

These two typical instances have been chosen to illustrate the difficulty encountered in the classification of the Tribal returns and the meaning they convey. On the one hand there is little to distinguish between certain Tribal beliefs and the religion of the masses of the lower strata of Hindu population ; on the other a section of the Tribal group is distinctly outside the Hindu social organisation.

189. Tribal returns influenced by three factors.—The Tribal returns are influenced by three factors—geographical, propaganda in the direction of a genuine Hinduising movement and the idiosyncrasy of the Census enumerator. The geographical factor affords an interesting clue as to the boundaries of the Tribal and the Hindu zones. The more remote and inaccessible an area where the tribes live the greater should be the number that should return themselves as Tribal. South Rewa, a portion of Nimar district of Indore, the Satpura division in Barwan State, practically the whole of Ali-Rajpur and Jhabua are geographically isolated regions but the returns are subject to the whim of the enumerator. The second Tribal zone is midway between these inaccessible places and the plains. This Bhil *parus* in the hills are scattered as they don't live with other communities but they visit the villages and the weekly markets. Their contact with the plain is constant. In the plains they live in a separate colony by themselves like the lower castes and they are generally Hinduised. As regards organised propaganda there is very little of it in evidence. The Hindu feels no interest in the denizens of the jungle. Excepting the Roman Catholic Mission in Jhabua nobody works amongst the hill tribes in Central India. There is therefore no militant programme in the direction of Hinduising them. Certain subtle forces however are at work. The local Vindhyan aristocracy is of mixed Rajput and Bhil descent and it is making a bid to transform itself to any one of the well-known Rajput clans. It wields some influence in creating opinion amongst the Bhils in their attitude towards Hinduism. A conference held under the auspices of one of the Chiefs some time before the Census called upon the Bhils to return themselves as Hindus. This had had an effect in influencing the Bhil figures in some of the States of the Southern Central India Agency. Lastly there is the enumerator. While in other religions, the enumerator is generally not apt to make a mistake, in recording the Tribal religion he is up against difficulties which are not his own making. He is poorly equipped to understand the nature of the Tribal religion. Though his instructions were to find out what a Bhil himself answered in actual practice it works otherwise. Again there is a great dearth of local enumerators. In the backward areas the number of literate persons is strictly limited and it is difficult to induce people

¹ R. R. Marrett, art. Animism, *Encyclopædia Britannica*, 14th edition.

to visit the scattered homes in the tribal areas. Very little control can be exercised over the enumerating agency and it is a matter of doubt whether the

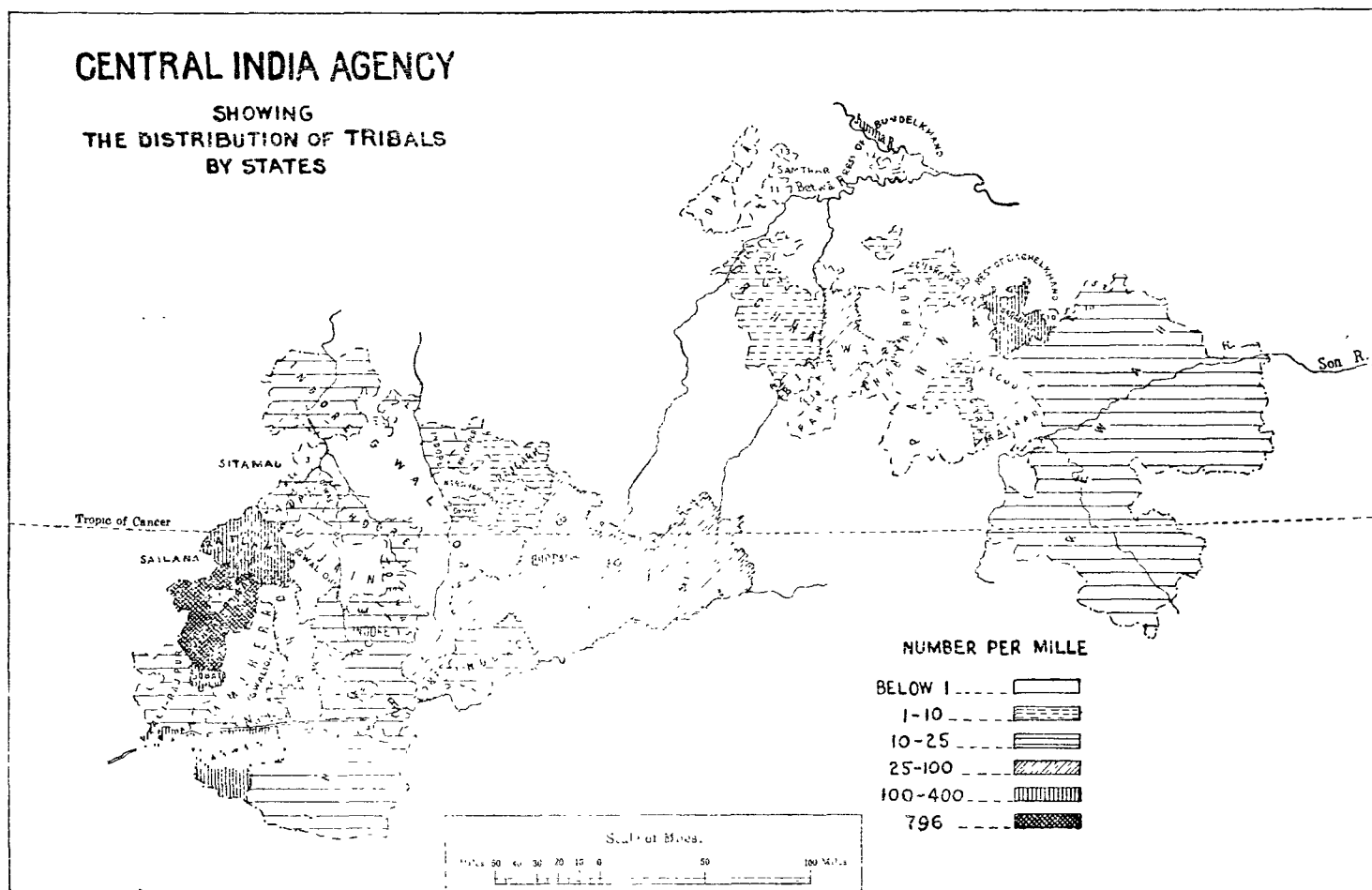

instructions filter down to them. To sum up, the difficulty lies in drawing a line between Animism and Hinduism, in separating and isolating the tribal areas from other regions and in the intrusion of the personal whim and factor of the enumerator. These factors render the returns inaccurate and even misleading. The degree of error is not constant from Census to Census to make the figures even comparable. To a large extent discussions are rendered unreal.

190. **Variation.**—The Tribal population shows a net decrease of 58,717

Variation in the Tribal Population by Political Charges.

Political division.	1931.	1921.	Variation.
1	2	3	4
Indore	27,313	27,307	+6
Bhopal Agency	53,807	50,699	+3,108
Malwa Agency	47,592	35,956	+11,636
Southern States in Central India.	163,195	235,503	-72,308
Bundelkhand Agency	5,196	10,871	-5,675
Baghelkhand Agency	40,379	39,133	+1,246

over the figures of 1921. The marginal table shows the variation by political charges. The figures for Indore practically show no change while there is a heavy fall in the Southern States Agency. The following figures taken from Subsidiary Table II for the principal States of the Southern States Agency are interesting. Only Jhabua shows a natural

increase. The others show a violent variation that cannot be explained

Tribal Variation per 10,000 of the Population.

State.	1931.	1921.
1	2	3
Ali-Rajpur	136	2,990
Barwani	1,323	4,548
Dhar	911	2,503
Jhabua	7,955	6,566
Jobat	8	4,457

rationality. Jobat has completely cast away the Tribal group possibly with no effort whatever. The same story is repeated in some of the States in the Bundelkhand Agency. In Panna, in 1921 the total strength of the Gonds and Kols returned as Animists was 10,024. In 1931 they have all vanished leaving not a soul behind. In the neighbouring State of

Bijawar the reverse is the case. The Sonr who was classed as a Hindu in the

Tribal Variation per 10,000 of the Population.

State.	1931.	1921.
1	2	3
Ajaigarh	70	64
Bijawar	266	8
Chhatarpur	4
Orchha	44	507
Panna

previous Census has suddenly been put back as a Tribal which perhaps he is but not a Sonr has been shown as a Hindu this time. Thus 3,079 tribals have now been returned in Bijawar as against the lonely two males who had adorned the Animistic column in the last decade.

191. **Composition of the tribal group.**—The composition of the Tribal group shows much variation from Census to Census. In 1901, the following twelve tribes were fixed as falling under that category :—

- | | | |
|--------------|--------------|---------------|
| (1) Arakh. | (2) Bharud. | (3) Bhil. |
| (4) Bhilala. | (5) Gond. | (6) Kirar. |
| (7) Kol. | (8) Korku. | (9) Kotwal. |
| (10) Mina. | (11) Patlia. | (12) Saharia. |

This however is purely arbitrary and is more in the nature of an estimate than of enumeration. The Caste table provides an insight as to the castes and tribes who have contributed to the Tribal figures.

Tribals by caste.

Name.	Strength.	Name.	Strength.
1	2	1	2
<i>Recognised Tribes</i>	337,043	<i>Wandering, Criminal and other classes</i>	714
1. Baiga	4,899	21. Bagri	9
2. Barela	108	22. Banjara	184
3. Bemariha	36	23. Bedia	11
4. Bharia	460	24. Kalbelia	101
5. Bhil	218,288	25. Kanjar	160
6. Bhilala	6,630	26. Mina	31
7. Bhumia	73	27. Moghia	155
8. Gond	74,058	28. Sansi	63
9. Khairwar	214	<i>Recognised Castes</i>	2,906
10. Kol	6,723	29. Agarla	873
11. Korku	5,348	30. Baeckada	73
12. Majhi	1,033	31. Chamar	58
13. Mankar	49	32. Dhanuk	12
14. Mawasi	2,848	33. Ghasia	38
15. Nihal	702	34. Kir	18
16. Pathari	101	35. Kirar	185
17. Patlia	11,140	36. Kotwar	101
18. Saharia	1,492	37. Mahra	6
19. Sor (Sonr)	2,824	38. Naik	10
20. Pao	17	39. Panika	1,532
		<i>Obscure Names</i>	89
		40. Kamtai	76
		41. Salia	13

The first 20 constitute practically all the recognised primitive tribes which have Tribal and Hinduised sections. The inclusion of the criminal and wandering tribes like Bagri, Bedia, Kanjar, Kalbelia and Sansi in the Tribal figures is the work of the enumerator. The absurdity of the returns under the recognised Castes is evident. The cultivating Castes of Kir and Kirar, Panikas who are weavers, Ghasias who are grass-cutters and the Chamar, Dhanuk, Kotwar, etc., who are low impure castes of varying degrees, are all definitely Hinduised castes and their inclusion cannot be justified.

There is no doubt a process of absorption is going on steadily but the figures for reasons already explained form no true index. The following table gives the figures but supplies us with no rational explanation.

Variation in the Hinduised proportions among certain tribes.

Caste.	IN 1931.		PROPORTION PER 1,000 RETURNED AS HINDU.	
	Number returned as Tribal.	Strength of the caste.	1931.	1921.
1	2	3	4	5
1. Bhil	218,288	363,124	399	146
2. Bhilala	6,630	193,775	966	997
3. Gond	74,058	282,397	738	649
4. Kol	6,723	200,249	966	966
5. Korku	5,348	17,815	700	470
6. Baiga	4,899	35,813	863	1,000
7. Sor	2,824	17,920	842	1,000

While some are Hinduised, others like Baiga and Sonr have been de-Hinduised. On general considerations we are led to infer that the process of absorption is not so rapid as the figures would suggest. The consciousness of the tribes has not yet been roused to a pitch to make them feel that they are outside the pale of civilization. There is no centre of propaganda from which a wave of ideas are set in motion which will have an energizing effect on the tribes and their outlook on life. The Hinduism of the plains evinces little or no interest in them and as yet has taken no initiative in any organised propaganda. No incompatible culture forms have been imposed on them producing unrest and restlessness in their organisation or forcing them to succumb *en masse* to the strangling effects of the more powerful ones. Though not strictly secluded as in former times their contact with the outside world is still furtive. Administration in the parts where they live is to a large extent decentralised. Forest laws are not rigid in the States. Officials and visitors do not frequent their parts and communications are meagre. There is therefore reason to think that the tribes do maintain some sort of seclusion and cohesion and their intercourse with the outside world is more restricted than we are sometimes led to suppose.

A word may be added before we leave the Tribal religion. As a separate head in the religion table, the figures for Tribal possess no value whatever, but as a clue to follow that small corpus which is left behind after being subjected to the solvent of Hinduism, it has its value. We need some guidance to spot out a possible Tribal belt. We see its identity but we fail to come to grips with it. In that lies some justification for the collection of Tribal statistics.

192. **Muslim.**—The distribution of the Muslim population in the Agency strictly follows the historical causes. Early in the 13th century the forces of Islam invaded Central India. In 1203, the Chandel fortress of Kalinjar fell and Mahoba was occupied. It entrenched itself on the fertile plains but never penetrated the rugged and mountainous home of the Bundelas and of the Baghels. The more exposed Malwa underwent a different fate. Itutmish raided Malwa early in the 13th century. By 1310 it was more or less subdued by the Khilji Rulers and towards the close of the century an independent kingdom was set up whose capital was first at Dhar and then at Mandu, whose magnificent ruins attest to the existence of a rich and powerful domain. The Moghals destroyed this independent principality and Malwa became a *subah* under their Empire. Though dominated, the Rajputs were not completely subdued and under the Moghals, whose rule they upheld, they enjoyed power and extended their principalities in Malwa.

Up to the advent of the Moghals, conversions must have been the normal state of affairs and they must have decreased with the growth of Rajput autonomy. The collapse of the court at Mandu must have spelt ruin and disaster to the nobility

and the upper classes amongst the Muslims, scattering and merging them in the general population. For some reason in this period Islam failed to plant and leave behind a strong colony.

Speaking about the decadence of the Arabs and of Islam, a recent French observer writes :—
“ The gravest error committed by the Arab conqueror was in compelling the conquered peoples to become converts to Islam. By the fact of conversion, the vanquished became the equal of his vanquisher, entitled to enjoy the same rights, the same privileges ; and as in the majority of cases he was his superior in intelligence and intellectual culture, he came to exercise a preponderating influence ; so that the conquering Arab, by the very reason of the rapidity and extent of his conquests, found himself, as it were, drowned in a sea of foreign peoples who imposed their manners upon him and corrupted him. They dominated him all the more easily as he was incapable, through want of knowledge and experience of taking the lead and of establishing his moral authority.”¹

The subject populations submerged the conqueror and such perhaps was the ephemeral nature of the dominion of Islam that Malcolm shrewdly observed that ‘ there cannot be a stronger proof of the conditions of the Muslim population than that there is hardly to be met a priest or religious person of any rank, learning or character, among the best societies of that tribe in Central India ’.²

Under the Maratha rule in Malwa, the composition of the Muslim population was influenced by the rise of the Pindaris and the establishment of the Afghan ruling houses in Jaora and in Bhopal. The Pindaris were of all classes but some of their important leaders were Muslims. They converted many of the children and the men whom they took as their prisoners. Many low caste Hindus also became converts ‘ to obtain honourable association with the fellow Pindaris ’.³ With the break-up and the dispersal of the Pindaris, this class of people merged into the general population and together with the earlier strata they now form the bulk of the Muslim rural population.

The Pathan, Sayyad, and Moghal elements of the population constitute about one-third of the total Muslim population and they contain a strain of foreign racial element. The Sheikhs form another third and they certainly contain a large population—we shall not attempt to say how much—of the *nau*-Muslims or the converts from Hinduism. The Muslim branches of the occupational castes are almost all derived from the local converts. The Muslim armies were mere camps at Mandu, or Dhar or Sarangpur. Such Muslim occupational groups like Darzi, Kachera, Lohar, Teli, Mehtar, Dhobi, etc., were recruited from the Hindu section to meet the needs of the court and the camp. Surrounded in overwhelming numbers by the Hindus, the Muslim masses have nowhere retained the rigidity of Islam. The Nayatas for example have Hindu names, dress like them and their social customs are a mixture of Islam and Hinduism. They worship *Ganesh* and observe all the Hindu festivals.

193. **Distribution.**—The distribution of the Muslim population is shown in

Proportion of Muslims per 10,000 of the population in certain States.

Locality.	Number.
1	2
Jaora	1,593
Bhopal	1,231
<i>Central Malwa.</i>	
Dewas (Senior and Junior)	1,061
Indore	808
Dhar	692
Ratlam	1,125
<i>Southern Malwa.</i>	
Ali-Rajpur	230
Jhabua	172

the map. The largest concentration is in the two Muslim States of Bhopal and Jaora in western Central India. The further away we move from central Malwa they rapidly diminish in numbers and in hilly area they form a very insignificant proportion. The regional distribution is even more uneven. The total Muslim population of Bhopal is 89,860. Of this 37,618 or 42 per cent. are concentrated in Bhopal town

and if we take the towns in Imperial Table V the percentage of Muslim urban

¹ *Islam and the psychology of the Musalman* by André Servier, 193.

² *Memoir*, ii, 114.

³ *Memoir*, ii, 111.

population comes to 59. In Jaora 10,820 out of the total Muslim population of

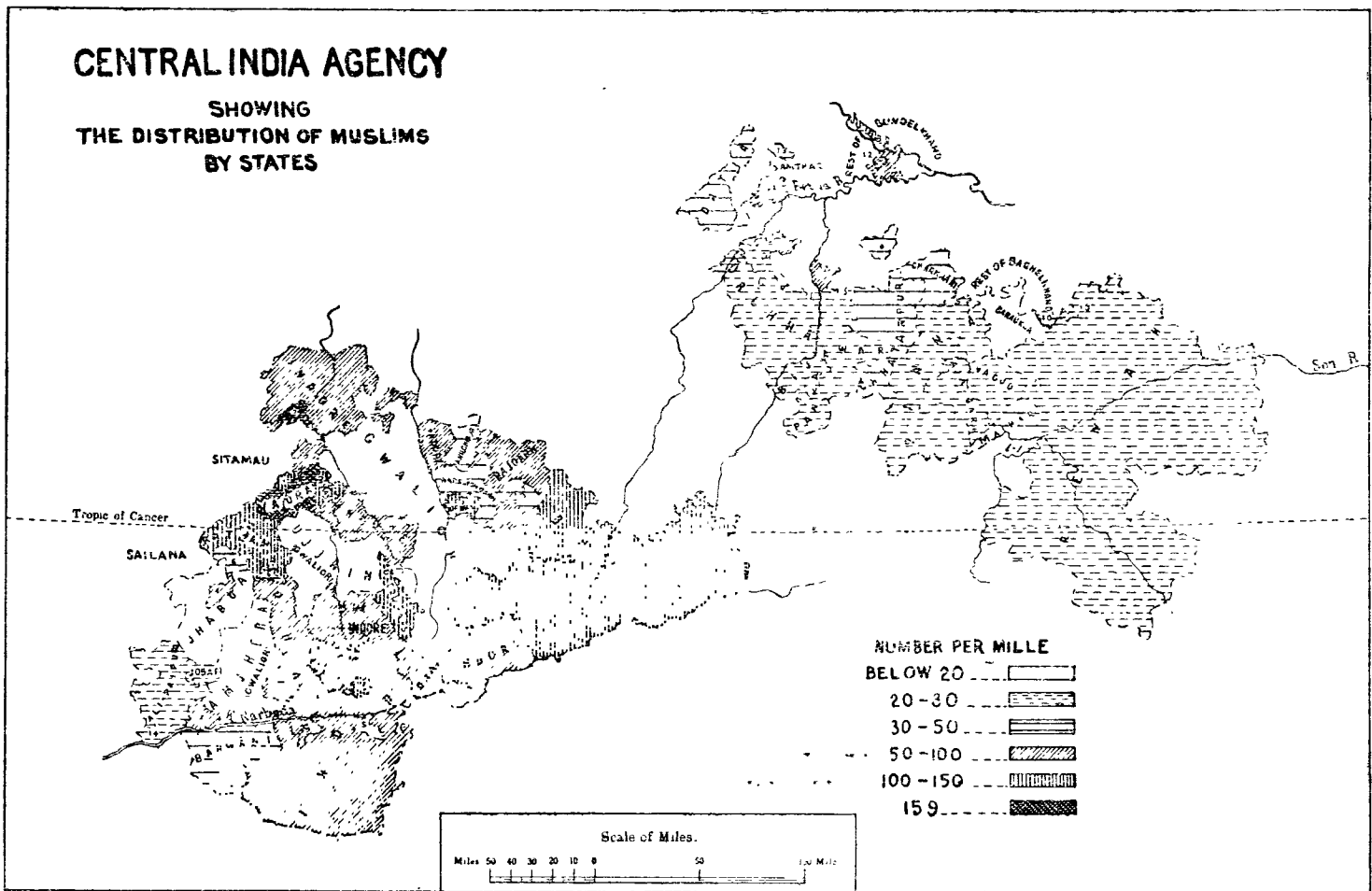

15,961, live in Jaora town, i.e., 68 per cent. The figures for Ratlam are

Proportions per 10,000 of the population in certain Eastern States.

Locality.	Number.
1	2
Samthar	740
Chhatarpur	420
Orchha	258
Panna	219
Rewa	222
Baraundha	62

obsured by Ratlam City which is a railway centre and attracts outside people. The distribution is uneven and artificial. The striking change as we move east is brought out by the figures for few States in the East.

194. **Variation.**—In the decade the Muslims have increased by 13·4 per cent. as against 12·1 for the Hindus. In the previous decade there was a decrease of ·7 per cent. as against a fall of 2·2 per cent. in the case of the Hindus. The Hindus suffered heavily in the Influenza mortality. The Muslims variation is not at the expense of the Hindus who make good their differential variation by influx from the Tribal rank. A great majority of the Muslims live in towns. Their diet is richer and they possess an advantage over the Hindus in not having any restrictions over widow-remarriages and a comparatively general absence of very early marriage. The absence of vital statistics precludes a discussion of natural growth as revealed by birth and death rates. Conversion has ceased to exist and there is no appreciable volume of migration, such as would influence the figures. The variation in main therefore represents the natural growth during the decade.

195. **Christian.**—The total number of Christians enumerated is 10,476. Only two per mille profess this religion. More than half the number was enumerated in Indore State. The number recorded in the Western Division is 9,832 and the East accounted for 644 persons only. 94 per cent. of the total Christian population is therefore concentrated in the West. The figures are determined by three factors—railway communications where the Anglo-Indian and European

railway employees are generally concentrated, British military garrisons where British troops and officers are stationed and the presence of Christian missions who work among the masses and are engaged in the spread of Christian religion. All these are at work to a greater degree in the West. Railway communications are more extensive in the West than in the East. In the former there are three important railway colonies, *viz.*, Ratlam, Mhow, and Bhopal. Mhow is the only large garrison station in Central India. Nowgong has ceased to be a purely Military Station. There is only a College now—the Kitchener College—to train Indian Officers of the Indian Army. Indore is the chief centre of missionary activity and the sphere of mission work is widespread over the whole of Malwa and the southern parts of the Agency. The mission activity in Nowgong and round about in the Chhatarpur State is limited. The figures for East are contributed mainly by Nowgong and Rewa. The latter has a colliery at Umaria and Sutna town has a railway colony and Cement factories.

Twenty years after the Mutiny, the missionary activities started in Central India. Of the missions that are engaged in active work, by far the most important is the Canadian Presbyterian Mission, now known as the United Church of Canada Mission. The Roman Catholics have stations at Mariapur (in the British Pargana of Manpur), Thandla, Jhabua and Rambhapur all in Jhabua State and Barwani. The Friends Mission at Sehore have closed down their activities owing to financial stringency and the work has been taken over by the Canadian mission at Indore. The American Friends Mission works at Nowgong.

I am indebted to Reverend A. A. Scott, General Secretary to United Church of Canada Mission, for the following account regarding the activities of the mission :—

The United Church of Canada Mission, formerly known as the Canadian Presbyterian Mission, was established in 1877. In 1925 the Methodist and Congregational Churches and about 70 per cent. of the membership of the Presbyterian Church in Canada united to form the United Church of Canada, and the name of the Mission was changed as indicated.

The Mission has work at Indore, founded in 1877, where the Indore Christian College, the Malwa Theological Seminary, the Womens' Hospital and the Girls' High School are located ; at Mhow, opened in the same year, where there are schools ; at Nimach, established in 1885, where there is a Girls' Boarding School, a school for boys and a Womens' hospital ; at Ratlam, opened in 1886, where there are schools for boys and girls and a general hospital ; at Ujjain opened in the same year, where there are boys' and girls' schools and a general Hospital ; at Rasalpura (Mhow) started in 1902, where at a distance of about two miles from Mhow Cantonment a Christian boys' Vocational school is conducted ; at Kharua, opened in 1910, where there are schools for boys and girls and a dispensary ; at Jaora and Sitamau, opened in 1912, where Primary educational work is conducted ; at Banswara, S. Rajputana, where there are schools and a Hospital ; at Hat Piplia, begun in the same year, where there is a Primary school and a Women's Hospital ; at Mandleshwar, opened in 1928, where there is a general Hospital. In all stations, in addition to the institutional work, regular district work is carried on, and there are several out-stations attached to each main station.

This is the largest mission at work in Central India. Its foreign staff consists of 87 missionaries, male and female ; and the Indian staff numbers over 200. The mission works in the States and Administered Areas of Central India, in Gwalior, and has one station in Southern Rajputana. The Christian congregations which have come into being as a result of the activities of the mission are organised into the Presbytery of Malwa which is a part of the United Church of Northern India. The latest statistics show that within the bounds of the Mission, and connected with the United Church of Northern India there is a total Christian community of 7,291, of whom 6,755 are baptised members of the Church and 2,031 are communicants. It is probable that these figures will not correspond exactly with those of the Census Reports, largely because of the fact that the latter do not cover the same area for which the Presbytery of Malwa reports.

The mission carries on work among all classes of the community, and at the present time the largest accessions to the membership of the Christian Church are from the village communities.

Of the 8 Hospitals of the mission, 5 are conducted by the women and 3 by the men. In connection with these Hospitals, numerous dispensaries are conducted, both in the main stations and in the out-stations.

A great deal of educational work is carried on. The Indore Christian College is affiliated to the Agra University for the B.A. and M.A. degrees. The girls' High school in Indore prepares pupils for the High School Examination of the Board of High School and Intermediate education for Rajputana, Central India and Gwalior. The Malwa Theological Seminary give a training in Theology (through the medium of Hindi) to two grades of mission workers. The Rasalpura Vocational school combines the ordinary academic school course with a training in

carpentry, tailoring, printing and motor mechanics. In addition to these institutions there are some 40 schools of Primary and middle grade working in the various stations of the mission.

The regular evangelistic or district work comprises touring in the villages when the weather permits, the sale and distribution of literature, *bazar* preaching and all other forms of direct Christian work.

Formerly Amkhut, Mendha, Jobat and Barwani were stations of the mission, but when the union in Canada took place in 1925, the minority section of the Presbyterian Church which did not enter the union, organised itself into the Presbyterian Church in Canada, and these stations are now cared for by that body.

In 1929 the English Friends' mission which had for a long time been working at Sehore, decided to abandon that station. Several of the buildings of the missions were purchased by Reverend Dr. J. Fraser Campbell, a retired missionary of the United Church of Canada mission and he has been carrying on work there ever since with the help of a highly qualified Indian worker supplied by the latter mission. He has signified his intention of handing over his property to the mission.

The Roman Catholic mission works mostly amongst the Bhils. At Mariapur two schools are frequented by about 70 children. In Jhabua the mission runs a number of schools principally for the Christian Bhils where boarding is also provided for boys and girls. The priest in charge of the mission at Jhabua remarks that 'as for schools, the Bhils still hate schools'. The mission also does a good deal of work in providing medical aid in the villages.

The mission at Nowgong maintains 4 medical dispensaries and one hospital for women and children, besides maintaining primary schools in the district. Certain amount of general church work is also done.

The Christian population shows an increase of 15.6 per cent. in the decade. The Indian Christians who number 7,216 as against 5,077 in 1921, show a considerable rise. The other

Variation of Christian population in certain places.

Locality.	ACTUAL NUMBER.		Variation per cent. 1921-1931.
	1931.	1921.	
1	2	3	4
Jhabua	1,208	372	+224.7
Jobat	124	29	+327.6
Panth-Piploda	176	90	+95.6

Christians are a floating population and their variation is a matter of no particular interest. The first nucleus of the Indian Christian community was formed in the great famine of 1899, when the missions received considerable accessions. As unfortunately comparative figures prior to 1921 are not obtainable, we cannot follow the growth of the community. The figures for the decade however show considerable expansion in those parts where the mission work is active. The increase in Jhabua, Jobat and Panth-Piploda is easily attributable to conversions in the decade. The spread of Christianity in these parts cannot be rapid. Generally the work of the missions is of a restricted nature in the territories of Indian Rulers. Not that there is any active interference or hostility. On the other hand there is remarkable tolerance towards all religious faiths. But an unwritten and implied convention operates against any extensive activities. In States mission colonies cannot be planted as a matter of course or right but on good will and mutual understanding. It is never withheld in a good cause. Thus the forces of wise restraint operate in either direction. Secondly conversion makes much less appeal to the high Hindu Castes and it is not making any headway amongst them. At present the mission activities are confined to the few centres where the primitive Bhils are found and amongst the lower elements of the Hindu population. It is also a matter for doubt, whether the primitive tribes will contribute greater converts in the future. The probabilities are the disorganised, churchless Hinduism has far greater chances than the organised missions.

196. Europeans and Anglo-Indians.—The number of Europeans and Anglo-Indians is 3,213 as against 3,985 in 1921. Of these 2,477 are Europeans and allied races including Armenians. The following five States have returned the majority of them, small numbers being distributed over a few other States :—

Indore	2,186
Rewa	56
Bhopal	52
Chhatarpur	44
Ratlam	34

They are Civil and Military Officials of the Government and few are employees in different States. The Anglo-Indians who number 736 are mainly distributed in the following four places :—

Ratlam	135
Bhopal	134
Indore	311
Rewa	120

197. **Jains.**—The Jains constitute nearly one per cent. of the total population or 8 per mille. They are chiefly concentrated in the western Malwa States of Ratlam, Jaora, Sitamau and Sailana and in Bhopal, Indore and Dhar States. In the East they are chiefly found in Bijawar, Orchha and Panna. In Rewa and other States of Baghelkhand Agency, they are a negligible population.

Variation in the Jain proportion.

Locality.	PROPORTION PER MILLE.	
	1931.	1921.
1	2	3
Barwani	4	4
Bhopal	7	6
Indore	11	10
Jhabua	15	13
Panna	10	9

Variation in the Jain proportion.

Locality.	PROPORTION PER 10,000 OF THE POPULATION.	
	1931.	1921.
1	2	3
WEST.		
Ati-Rajpur	12	15
Dhar	136	149
Jaora	221	249
Ratlam	417	458
Sailana	240	275
Sitamau	203	274
EAST.		
Orchha	171	180
Bijawar	148	158
Datia	13	28

The Jain population shows an increase of 12.9 per cent. in the decade but this increase is only in few places. On the other hand in most other places where they are chiefly concentrated their population shows a decided fall. The reasons for this are not quite evident. The Jains are principally town dwellers and in times of epidemics they are apt to migrate. There was no such cause during the decade. I am inclined to suggest migration to another cause. The Jain follows the path of trade. It is nothing unusual for him to migrate to other parts if trade conditions are unstable, or not favourable to him. It is also possible that some of the Jain figures might have been included amongst the Hindu Banias. The Jain community have two main divisions, Oswal and Porwal, and they are distributed over Hindu and Jain religions.

198. **Aryas.**—In the last Census 529 Aryas in all were enumerated. Their present strength is 3,097. To this large increase Indore alone has contributed 2,113. Nagod (158), Barwani (111), Ratlam (130), Bhopal (165) and Dhar (85)—all these report Samajist activities. Our figures go to show that the decade has witnessed an active propaganda by the Samajists.

Indore is the chief centre of the Arya Samaj and it obtained a footing in the City as early as 1881 when the founder visited the place. It does not appear to have made much headway as at the time of the last enumeration there were only three Samajes in the State. The decade however has witnessed a remarkable expansion in its activities for there are now 16 Samajes working all over the State. The following are the reported centres :—

Indore.	Khargone.	Gautampura.	Garoth.
Narayangarh.	Bhikangaon.	Mahidpur.	Mhow.
Nandwai.	Petlawad.	Maheshwar.	Kangati.
Sanawad.	Sunel.	Samastipur.	Kuiyan.

Apparently the work of the Samajes has borne some fruit as is evident from the figures. In 1921, 235 Aryas were enumerated in the State and of this 184 were returned from Indore City, Indore Residency and the adjoining cantonment at Mhow. The number returned from the latter places this time is 325 or 382 if all the towns in Imperial Table V are taken. The bulk of the Arya returns are from

the rural areas where propaganda is spreading from the Samaj centres mentioned above.

In Indore the Samaj maintains the Shradhanand orphanage and its other activities include the maintenance of a Vedic Library, Reading Room and classes for the Depressed classes and propaganda on behalf of the Jat Pat Todak Mandal. Every Samaj has a regular constitution. It ordinarily consists of an elected president, the usual office bearers and members. Regular meetings are ordinarily held on Sundays. The proceedings open with the recitation of Vedic Mantras followed by a prayer in Hindi and a sermon on some religious or social subject. Under the rule of the Samaj each member pays one per cent. of his salary.

As regards conversions it is quaintly reported that though there is a fertile field for the movement the atmosphere is not congenial. Only stray conversions are claimed from Islam or Christianity and the number claimed for Indore is in the neighbourhood of over 100. The Samajes at present rely on peaceful propaganda and on activities connected with various social reforms such as of raising the age of marriage, of ameliorating the condition of women, of reducing expenses connected with ceremonies and of crusade against evil customs, intemperance, etc. A certain amount of vigorous activity, after a long period of dormance, is the chief feature of the decade. It remains to be seen whether the Samaj is really on the path of active proselytization.

199. **Others.**—Of the others, the Zoroastrians number 976. Out of them only 12 were enumerated in the East. Indore accounts for 760, Ratlam for 99 and Bhopal for 63. Few have found service in the States. The bulk of them are traders and settlers in the administered areas. The Sikhs number 1,426. They are mostly employed in the military forces of some of the States. The Buddhists represent the Chinese pedlars caught in the Census net. Of the 38 Jews enumerated, 33 were returned from Indore City, two from Bhopal City and three from Sutna town.

200. **General remarks: Present & future tendencies.**—The preceding discussions in this Chapter have shown that Hinduism with its oldest ally, Animism, is the dominant religion of Central India. It covers the religious outlook of 94 per cent. of the population. Islam has driven a small wedge in its otherwise composite structure. Other religious systems have been unable even to nibble its outer fringes. As often pointed out, Hinduism has spread without a church, a central organising authority and a clear cut definite creed, formless and proselytizing in its own way. It is not homogeneous. It has many sectional groups within it and in the 1901 Census 600 sects were recorded in this Agency. But its eclecticism operates in a way as not to divide it into water-tight compartments and to cause bitter discord and disharmony. In recent times, attention is being drawn to a process of attrition and disintegration in modern Hinduism as evinced by sectarian or religio-social movements. The Hinduism of these parts however shows no such active signs. It is not that the Hinduism of the masses of people in Central India is totally different from that of other parts or that it has not some of those elements which are contributing towards its disintegration elsewhere. What is absent is the play of external forces which working through its structure, force up problems to the surface and secondly the Hinduism of these parts is comparatively free from the rigid shackles of orthodoxy and of the strong hold of the Levites. The latter deserves a closer examination. While the Indo-Aryan religion was developing in the Gangetic plains, Central India was the stronghold of that heterodox system which later on came to be designated as Buddhism. Several of its most renowned adherents resided in western Malwa at Avanti—the modern Ujjain. According to Professor Rhys Davis, Buddhism born in Nepal received the garb in which we now know it in Avanti¹. In the period of its prosperity it was widely spread amongst the upper classes in Malwa. There is still much that is not definite in the early history of Central India. There appears to have been a period of anarchy after the fall of Buddhism and of adjustments owing to the incursions of foreign hordes and their consequent absorption into the Hindu social system. Evidence however points to the fact that Brahmanism was less dominant as attested by the prevalence of Jainism—the twin of Buddhism from west to as far east as Khajuraho. With the break up of the Hindu kingdoms in the north by the furious onslaught of Islam in the 11th and 12th centuries,

¹ *Cambridge history of India*, Vol. i, 187.

there was a dispersal and migration of people on a large scale and there is no doubt that the carriers of Hindu religion and culture spread in all directions. From this period onwards must be ascribed the migration of the present day principal castes and the spread of Neo-Hinduism to Central India. Driven and scattered away by the foreign hordes the Rajputs distributed themselves in Central India while the more unopened parts were held by the tribes. The Rajputs do not appear to have brought the Brahmans with them, for as Malcolm rightly noted it was the Charan or the Bhat who held a premier position in Rajput society. The Brahman had his due place for reverence to the Brahman is the pivotal point of Hinduism. But the Brahman unlike in other places, was not the sole law-giver. His influence was far less pronounced in rivetting and consolidating the Hindu society and in rigidly enforcing customs and rituals. The present day distribution of Brahmans is illuminating on this point. The Malvi Brahmans in Malwa and the Naramdeo Brahmans in the Narbada valley, are the only important local groups. The Deccani and the Gujarati Brahmans in the West and the Kanaujia Brahmans in the East are all migrants exerting little influence on the religion of the masses. A great majority of them have little connection with their sacerdotal functions. Nothing escaped the keen observation of Malcolm a century ago.

“ There is perhaps, no part of India, where the tribes of Brahmans are so various and their numbers so great as in Central India, but there is certainly none where there are so few of them either wealthy, learned or where there is less attention paid to the religious rites of the Hindu faith, or to its priests, by the rest of the population.”¹

The Hindu society in earlier times was not subjected to the cramping effects of a rigid rule imposed upon it by the Levites. It perhaps had more free-play. Hence, undisturbed at any time by internal convulsions due to the reforming or schismatic zeal of its adherents, or by being affected to any appreciable degree by the irritating effects of the uncompromising proselytization of another militant religion or to the erosion of the peaceful penetration of Christianity, this neo-Hinduism of the earlier days has pursued its placid even tenor of existence pickled in the preservative of a long-period of the autonomy of the Rulers in Central India. For centuries the masses have been satisfied with their religious values.

Neither has the Hinduism of the present day been subjected to the more powerful irritant of modern western culture. There again the autonomy of the Rulers has acted as a powerful buffer against the infiltration of outside influences. The spread of English education is still nascent and there is a large area which yet remains untouched. An educated middle-class is practically non-existent and where it exists it is inchoate. Platform, Press and Propaganda—the three powerful instruments in the spread of disaffection with the existing order of society—are absent. People at large have not yet thought of questioning the value of their beliefs and no class consciousness has arisen to spur them on to re-examine the fundamental constitution of their social structure. More than the abstract problems of religion, it is the social structure and the place assigned in it to the individual, that is convulsing the present day thought. The dynamic forces that operate—sometimes to the good and at others towards bad ends—behind the many ‘isms’ of the modern day have not crossed over perceptibly to these parts. How long the waves of inflowing ideas will be stemmed is a question that future alone can answer. Elsewhere there is an intense clash of culture brought about by the contact of Races and other resulting causes. Old values no longer satisfy in the existing conditions and a blind acceptance of facts is giving place to intense searchings and questionings. The unsettlements have brought about a deep malaise in their train and hence the strivings after credal, communal and racial unity. Having regard to the conditions prevailing in the States, there is no reason to warrant that the path of progress will lie through disintegration and convulsion. But Hinduism in these parts cannot remain in a static condition for ever. It has a large unassimilated and unreclaimed element which it claims in its fold. Some time or other adjustments will be called for. To those who wish to contemplate its future, the wise words of Bacon have a pregnant meaning “ Beware that it be the reformation that waiteth on the change and not the desire for change that precedeth the reformation ”.

¹ *Memoir*, ii, 124.

SUBSIDIARY TABLE I.

General distribution of the population by Religion.

Religion and locality.	Actual number in 1931.	PROPORTION PER 10,000 OF THE POPULATION.			VARIATION PER CENT. INCREASE (+) DECREASE (-).		Net variation per cent. 1911-1931.
		1931.	1921.	1911.	1921-1931.	1911-1921.	
1	2	3	4	5	6	7	8
<i>Hindu.</i>							
Central India Agency	5,848,519	8,817	8,688	8,688	+12.1	-2.2	+9.7
West	2,847,048	8,165	7,915	7,747	+15.5	+6.5	+22.4
East	3,001,471	9,541	9,509	9,569	+8.5	-8.7	-1
<i>Muslim.</i>							
Central India Agency	376,637	568	553	545	+13.4	-7	+13
West	291,857	837	816	830	+15.4	+2.4	+18.2
East	84,780	270	274	278	+6.4	-9.4	-2.6
<i>Tribal.</i>							
Central India Agency	340,752	514	666	674	-14.7	-3.3	-17.5
West	295,177	847	1,131	1,281	-15.6	-8.0	-28.6
East	45,575	146	172	105	-8.9	+49.8	+36.5
<i>Jain.</i>							
Central India Agency	50,268	76	74	78	+12.9	-6.6	+5.3
West	37,809	108	105	113	+16.4	-3.3	+12.4
East	12,459	38	41	44	-8	-14.4	-15.0
<i>Christian.</i>							
Central India Agency	10,476	16	15	12	+15.6	+18.1	+36.5
West	9,832	28	26	23	+22.2	+20.1	+46.8
East	644	2	3	3	-36.8	+4.5	-33.9
<i>Others.</i>							
Central India Agency	6,138	9	4	3	+153.5	+20.6	+200.3
West	5,126	15	7	6	+126.1	+21.8	+170.1
East	1,012	3	1	1	+561.4	+4.8	+593.2

N. B.—The figures for Khaniadhana have been included in the East.

SUBSIDIARY TABLE II.

Distribution by States in Central India of the main Religions.

Agency, Natural Divisions and States.	NUMBER PER 10,000 OF POPULATION WHO ARE											
	Hindu.		Muslim.		Tribal.		Jain.		Christian.		Others.	
	1931.	1921.	1931.	1921.	1931.	1921.	1931.	1921.	1931.	1921.	1931.	1921.
1	2	3	4	5	6	7	8	9	10	11	12	13
CENTRAL INDIA AGENCY .	8,817	8,688	568	553	514	666	76	74	16	15	9	4
West	8,165	7,915	837	816	847	1,131	108	105	28	26	15	7
1. British Pargana of Manpur .	4,143	5,481	543	672	4,772	3,387	22	39	374	390	146	31
2. Indore	8,801	8,806	808	795	207	237	114	104	41	45	29	13
<i>Bhopal Agency.</i>												
3. Bhopal	7,963	8,090	1,231	1,117	720	719	73	63	7	6	6	5
4. Khilchipur	9,183	9,489	310	285	203	216	4	10
5. Narsingharh	9,540	9,541	418	429	9	3	29	27	1	..	3	..
6. Rajgarh	9,423	9,452	538	525	18	..	18	20	1	..	2	3
<i>Mulwa Agency.</i>												
7. Dewas States	8,654	8,643	1,061	1,023	186	224	95	95	10	10	4	..
8. Jaora	7,970	8,117	1,593	1,556	206	72	221	249	8	4	2	..
9. Ratlam	5,563	5,611	1,125	1,156	2,775	2,675	417	458	96	88	24	..
10. Sailana	5,691	5,955	477	578	3,580	3,191	240	275	9	..	3	..
11. Sitamau	9,244	9,036	540	675	..	11	203	274	13	4
<i>Southern Central India States Agency.</i>												
12. Ali-Rajpur	9,566	6,685	230	245	136	2,990	12	15	56	64	..	1
13. Barwani	8,163	4,912	456	492	1,323	4,548	44	36	4	3	10	9
14. Dhar	8,244	6,657	692	677	911	2,503	136	149	9	8	8	6
15. Jhabua	1,639	3,087	172	181	7,955	6,566	150	134	83	30	1	2
16. Jobat	9,547	5,217	367	306	8	4,457	16	4	62	16
East	9,541	9,509	269	274	145	172	40	41	2	3	3	1
<i>Bundelkhand Agency.</i>												
17. Ajaigarh	9,586	9,577	280	297	70	64	63	62	1	..
18. Baoni	8,701	8,833	1,291	1,167	8
19. Bijawar	9,379	9,641	207	201	266	..	148	158
20. Charkhari	9,551	9,564	413	404	11	2	24	29
21. Chhatarpur	9,528	9,489	420	430	..	8	29	30	15	41	8	2
22. Datia	9,608	9,619	377	351	13	28	1	1	1	1
23. Orchha	9,525	9,544	258	272	44	4	171	180	1	..	1	..
24. Panna	9,656	9,166	219	224	..	507	101	99	1	3	23	1
25. Samthar	9,255	9,329	740	661	3	8	..	2	2	..
<i>Baghelkhand Agency.</i>												
26. Baraundha	8,153	9,911	62	88	1,778	7	..
27. Kothi	8,068	9,784	185	214	1,747
28. Maihar	9,678	9,691	307	302	7	..	4	3
29. Nagod	9,707	9,692	266	296	6	12	1	3	3	1
30. Rewa	9,590	9,499	222	223	179	272	6	5	21	..
31. Sohawal	8,818	9,618	248	239	905	138	27	4	2	1	1	..
Rest of Central India Agency	8,938	8,981	531	497	440	434	71	77	17	9	3	2

N.B.—The figures for Khandiadhana have been included in the East.

SUBSIDIARY TABLE III.

Christians—Number and Variation.

States.	ACTUAL NUMBER OF CHRISTIANS IN		Variation per cent. 1921-31.
	1931.	1921.	
1	2	3	4
CENTRAL INDIA AGENCY	10,476	9,062	+15.6
Ali-Rajpur	577	560	+1.4
Bhopal	502	423	+18.7
<i>Bhopal City</i>	387	234	+65.4
Chhatarpur	239	683	-185.8
<i>Nowgong Cantonment</i>	196	555	-183.2
Dewas (Junior)	103	77	+33.8
Dhar	221	191	+15.7
Indore	5,340	5,204	+2.6
<i>Indore City</i>	302	212	+42.5
<i>Indore Residency</i>	916	678	+35.1
<i>Mhow Cantonment.</i>	3,219	3,553	-8.6
Jhabua	1,208	372	+224.7
Jobat	124	29	+327.6
Panth-Piploda	176	90	+95.6
<i>am</i>	1,030	749	+37.5
<i>atlam City</i>	1,009	735	+37.3
<i>ewa</i>	265	178	+48.0
British Pargana of Manpur	256	178	+43.8
Rest of Central India Agency	435	129	+237.2

SUBSIDIARY TABLE IV.

Religions of Urban and Rural Population.

Natural Division.	NUMBER PER 10,000 OF URBAN POPULATION WHO ARE						NUMBER PER 10,000 OF RURAL POPULATION WHO ARE					
	Hindu.	Muslim.	Tribal.	Jain.	Chris-tians.	Others.	Hindu.	Muslim.	Tribal.	Jain.	Chris-tians.	Others.
1	2	3	4	5	6	7	8	9	10	11	12	13
Central India Agency	6,907	2,639	37	269	101	47	9,035	332	568	54	6	5
West	6,519	2,935	45	328	124	49	8,448	476	984	71	12	9
East	8,104	1,725	10	87	29	45	9,621	188	152	37	1	1

NOTE.—The figures for Khaniadhana have been included in the East.

APPENDIX A.

Statistics relating to Social Map of Central India Agency.

Units.	Total population (Persons only).	PRIMITIVE TRIBES (TRIBAL RETURNS ONLY).		HINDUS.				MUSLIMS.		OTHERS (ALL OTHER RELIGIONS COMBINED).	
		Absolute strength.	Percentage.	DEPRESSED CLASSES.		OTHERS.		Absolute strength.	Percentage.	Absolute strength.	Percentage.
				Absolute strength.	Percentage.	Absolute strength.	Percentage.				
1	2	3	4	5	6	7	8	9	10	11	12
CENTRAL INDIA AGENCY	6,632,790	340,752	5.1	797,844	12.0	5,054,360	76.2	376,637	5.7	63,197	1.0
1. Rewa	1,587,445	28,483	1.8	112,570	7.1	1,409,885	88.8	35,307	2.2	1,200	0.1
2. Indore	1,318,237	27,313	2.1	174,399	13.2	987,940	74.9	106,573	8.1	22,012	1.7
3. Bhopal	729,955	52,533	7.2	110,418	15.1	471,052	64.6	89,860	12.3	6,092	0.8
4. Orchha	314,661	1,382	0.4	49,671	15.8	250,033	79.5	8,128	2.6	5,447	1.7
5. Dhar	243,430	22,177	9.1	19,814	8.1	180,946	74.4	16,851	6.9	3,642	1.5
6. Panna	212,130	30,406	14.3	174,918	82.5	4,641	2.2	2,165	1.0
7. Chhatarpur	161,267	29,580	18.3	124,136	77.0	6,767	4.2	784	0.5
8. Datia	158,834	30,030	18.9	122,577	77.2	5,993	3.8	234	0.1
9. Dewas States	153,834	2,860	1.8	25,683	16.7	107,326	69.8	16,324	10.6	1,641	1.1
10. Jhabua	145,522	115,766	79.6	1,905	1.3	21,949	15.1	2,503	1.7	3,399	2.3
11. Barwani	141,110	18,665	13.2	8,163	5.8	107,143	75.9	6,439	4.6	700	0.5
12. Rajgarh	134,891	248	0.2	24,449	18.1	102,675	76.1	7,262	5.4	257	0.2
13. Charkhari	120,351	130	0.1	22,477	18.7	92,477	76.8	4,976	4.1	291	0.3
14. Bijawar	115,852	3,079	2.7	22,996	19.8	85,667	73.9	2,407	2.1	1,703	1.5
15. Narsingharh	113,873	101	0.1	20,542	18.0	88,113	77.4	4,757	4.2	360	0.3
16. Ratlam	107,321	29,782	27.8	7,436	6.9	52,398	48.8	12,070	11.2	5,635	5.3
17. Ali-Rajpur	101,963	1,387	1.3	2,207	2.2	95,328	93.5	2,342	2.3	699	0.7
18. Jaora	100,166	2,069	2.1	15,202	15.2	64,627	64.5	15,961	15.9	2,307	2.3
19. Ajaigarh	85,895	605	0.7	13,920	16.2	68,423	79.7	2,400	2.8	547	0.6
20. Nagod	74,589	8,577	11.5	63,985	85.8	1,982	2.6	45	0.1
21. Maihar	68,991	48	0.1	6,013	8.7	60,775	88.1	2,117	3.0	38	0.1
22. Khilchipur	45,583	925	2.0	6,354	13.9	36,871	80.9	1,412	3.1	21	0.1
23. Sailana	35,223	12,610	35.8	2,495	7.0	17,561	49.9	1,678	4.8	879	2.5
24. Sitamau	28,422	4,315	15.2	21,959	77.3	1,535	5.4	613	2.1
25. Samthar	33,307	6,550	19.6	24,276	72.9	2,465	7.4	16	0.1
26. Rest of Bhopal Agency (including Kurwai).	27,674	4,676	16.9	18,246	65.9	4,148	15.0	604	2.2
27. Rest of Southern Central India States Agency (including Jobat).	38,621	5,200	13.5	640	1.7	31,641	81.9	982	2.5	158	0.4
28. Rest of Bundelkhand Agency (including Baoni and Khaniadhana).	104,388	18,909	18.1	79,078	75.8	5,667	5.4	734	0.7
29. Rest of Baghelkhand Agency (including Baraundha).	108,231	11,848	11.0	15,126	14.0	79,191	73.1	1,930	1.8	136	0.1

CHAPTER XII.

Race, Tribe and Caste.

201. **The basis of the figures.**—The information pertaining to this Chapter was obtained from column 8 of the Schedule and the following instructions were printed on the Cover :—

For Indians enter caste as ordinarily understood. Among Hindus write sub-castes of Brahmans, Rajputs and Baniyas, such as, Brahman-Dakshani-Karhada, Kashmiri-Saraswat, Shrigaud or Bavisa; Rajput-Rathor, Rajput-Bundela, Rajput-Baghela, Rajput-Ponwar; Bania-Agarwal, Bania-Oswal. For Muslims the racial groups of Sheikh, Sayyad, Moghal and Pathan should be shown and the functional groups, such as, Jolaha, Behna, Bhishti, should be added where necessary, *e.g.*, Sheikh-Bhishti. For other subjects of the Empire and for foreigners enter race, as “Anglo-Indian”, “Canadian”, “Goanese”, “Turkish”. For Indians such as some Christians who have neither caste nor tribe enter “Indian”.

202. **Scope of the Caste Returns and their tabulation.**—Before explaining the method followed in tabulating the Caste returns in this Census, it is necessary to state how the Caste statistics were dealt with in the preceding decades as well as the peculiar conditions of this Agency in relation to Caste tabulation. So far as it is known there is no complete list of castes for the Agency and neither is a caste index of any of the previous Censuses available. Owing to the absence of an ethnographic survey detailed information for many of the castes is lacking and there is no information available regarding the caste structures of many of the localised groups. The gap in the knowledge is no doubt made good by references to the excellent ethnographic accounts of the neighbouring British Provinces as many castes are common to the contiguous parts but still in matters of detail our information pertaining to the castes is somewhat indefinite. This lacuna has affected the tabulation of castes and is responsible for certain castes to put in fitful appearances in the Caste tables of the previous decades. Thus Agaria, Bharia, Dhirkar, Khairwar, Kondar, Barela, Meghwal and Pathari—to name a few—pass in and pass out for no very apparent reason. They are all settled and localised groups in the different parts of the Agency. In 1901, a large number of castes were tabulated by political charges. In the next two succeeding enumerations castes over a strength of one thousand were tabulated and only an Agency Summary was published. With the excision of Gwalior, the strength of many castes have changed and the caste composition of the population has also been affected as northern Gwalior ethnographically differs somewhat from Malwa. It is also apparent that a bald Agency Summary without the local distribution of castes in a complex area as in Central India possesses no value whatever. In view of these considerations, it was decided to tabulate by States all the castes returned by the population. For the purposes of Imperial table XVII, the castes were divided into two classes, *viz.*, (i) major castes of general dispersion and (ii) minor and localised castes. In part I of the table the former have been shown by States. In part II the latter have been arranged in alphabetical order under the religion returned in each case. In cases of importance—ethnological or otherwise—the principal localities which have returned the caste have also been shown. Table XVII gives figures for 103 main castes and for 210 minor or local castes. In spite of the general instructions to curtail the statistical output in certain tables a complete tabulation of the castes was undertaken with a view to obtain caste statistics for the Agency as at present constituted and also to provide the material which may be useful for any future ethnographic survey.

203. **Caste classification.**—It is manifestly impossible to deal individually with the three hundred and odd labels which the caste table exhibits. We have to adopt some method of classification while considering them demographically. In this we are soon up against the complexities of the caste system and so far no satisfactory method has met with recognition. The unsatisfactory system of arranging the castes by social precedence was discarded in 1911 as it roused good deal of controversy and caste jealousy. In the last two Censuses the castes

have been arranged in this Agency by their traditional occupation. While there is much to be said in favour of such a classification for a conservative area like Central India where the population shows signs of strongly clinging to traditional occupations, there are other considerations which go against its adoption as a very satisfactory arrangement. There are many members of a particular caste who do not follow their so-called traditional occupation and this is specially the case with the higher castes. To take an example. Under the head Priests and Devotees, we show three important castes—Brahman, Bairagi and Baiga. Now amongst the Brahmans, a majority like the Dakshani Brahmans are officials and civil functionaries, a considerable number of Sarwaria and other Brahmans of the East are cultivators, many are petty menials and a few are even members of a criminal tribe. The Baiga may be a priest of some kind but he is an inveterate sorcerer who propitiates the spirit of a tiger. Many Rajputs again are cultivators and so are the Bhils and Bhilalas who have settled in the plains. The castes in the upper strata are taking to different occupations as they are more favourably placed by virtue of their cultural equipment, education and opportunities. While those who wish to rise from the lower strata, are ever troubled by an inferiority-complex from which they suffer, rightly or wrongly. An advanced section of a lower caste considers it unfair to be branded with the reputed traditional occupation of an earlier generation and the more despised the occupation is, the greater is the claim advanced by the class-conscious members of that community towards their recognition to a higher status. For with all his worldly attainments, a member of a lower caste may not make much impression in the world of caste for caste snobbery will always assert itself and say 'Oh! such and such is only a Kalar or a Lohar.' In fact the classification by traditional occupations also wounds the tender susceptibilities of the sensitive sections of the different castes and is liable to the charge that it perpetuates caste distinctions which, as we shall see in a later paragraph, is a complaint levelled against the Census. A minor difficulty in Central India is the table of occupation by selected castes has been abandoned for the Agency as a whole. To circumvent all possible objections and difficulties is not an easy task. For practical purposes the main figures can be satisfactorily elucidated by certain broad classification supplemented by a table giving the variation in strength of the principal castes arranged alphabetically. The Hindu castes broadly fall into fairly well-defined divisions. At one end we have the upper castes—Brahman, Rajput and Bania. At the other end we have the Hinduised and Tribal sections of the hill and forest tribes and certain low castes who have obtained a distinct recognition by the unsatisfactory appellation of 'depressed classes.' In between them are the different, functional, artisan, cultivating and a sprinkling of better castes and a host of minor castes which include wandering, criminal and other Hinduised tribes and castes of varying degrees of purity and impurity and of respectability and servility. Such a classification may appear crude and arbitrary. It has however one merit about it. It attempts to differentiate the different cultural planes in which the groups have been placed. The cultural equipment of the upper castes enables them to protect themselves in the struggle for existence while the mental faculties of a considerable group are yet in an undeveloped stage. The large number of castes who fill our table are in various stages of mental development. The study of caste has hitherto proceeded on the lines of collecting a large mass of information regarding caste customs and restrictions relating to connubium and commensality and it may not be long when it will resolve itself to the more difficult psychological methods of study of the mental equipment of the different social groups.

204. Accuracy of the returns.—Inaccuracies in the caste returns can easily be exaggerated and their consequent inutility may light-heartedly be advanced. It is necessary therefore to emphasise that in the Abstraction stage every possible care was taken to check all doubtful entries. At the same time it is not denied that the figures are affected by several kinds of unintentional errors. The absence of precise information about the local castes, renders the task of checking more difficult. In the backward areas the enumerating agency is apt to give trouble and a want of efficient supervision results in imperfect entries. This gives rise to few perverse entries, such as, Bengali, Gujarati, Hindustani, etc., which could easily be avoided. More often—this is the cause of the unspecified entries—are met with those obscure names which get recorded out

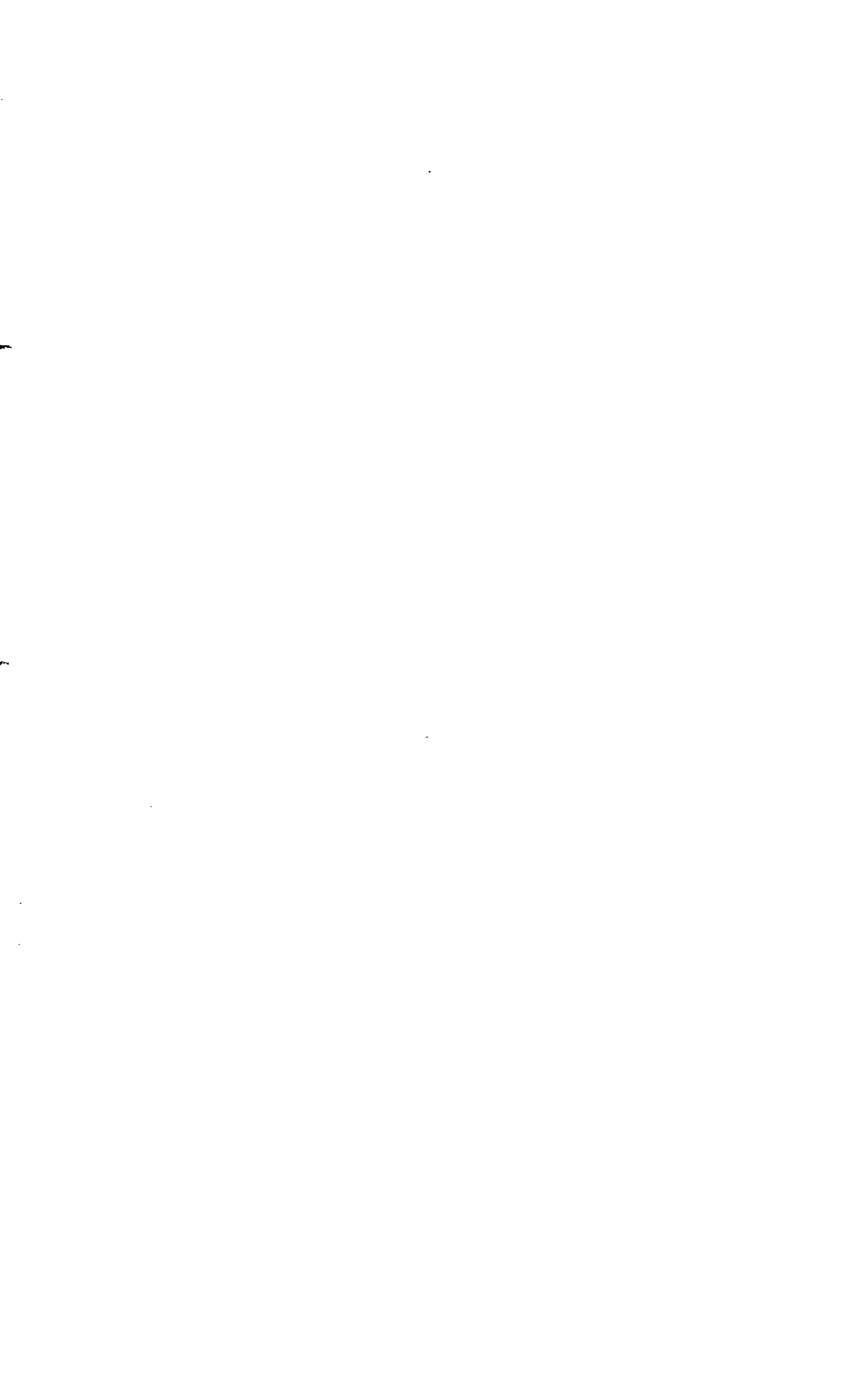

**DIAGRAM SHOWING THE PROPORTIONATE
DISTRIBUTION OF THE MAIN CASTES
AND CLASSES IN CENTRAL INDIA.**

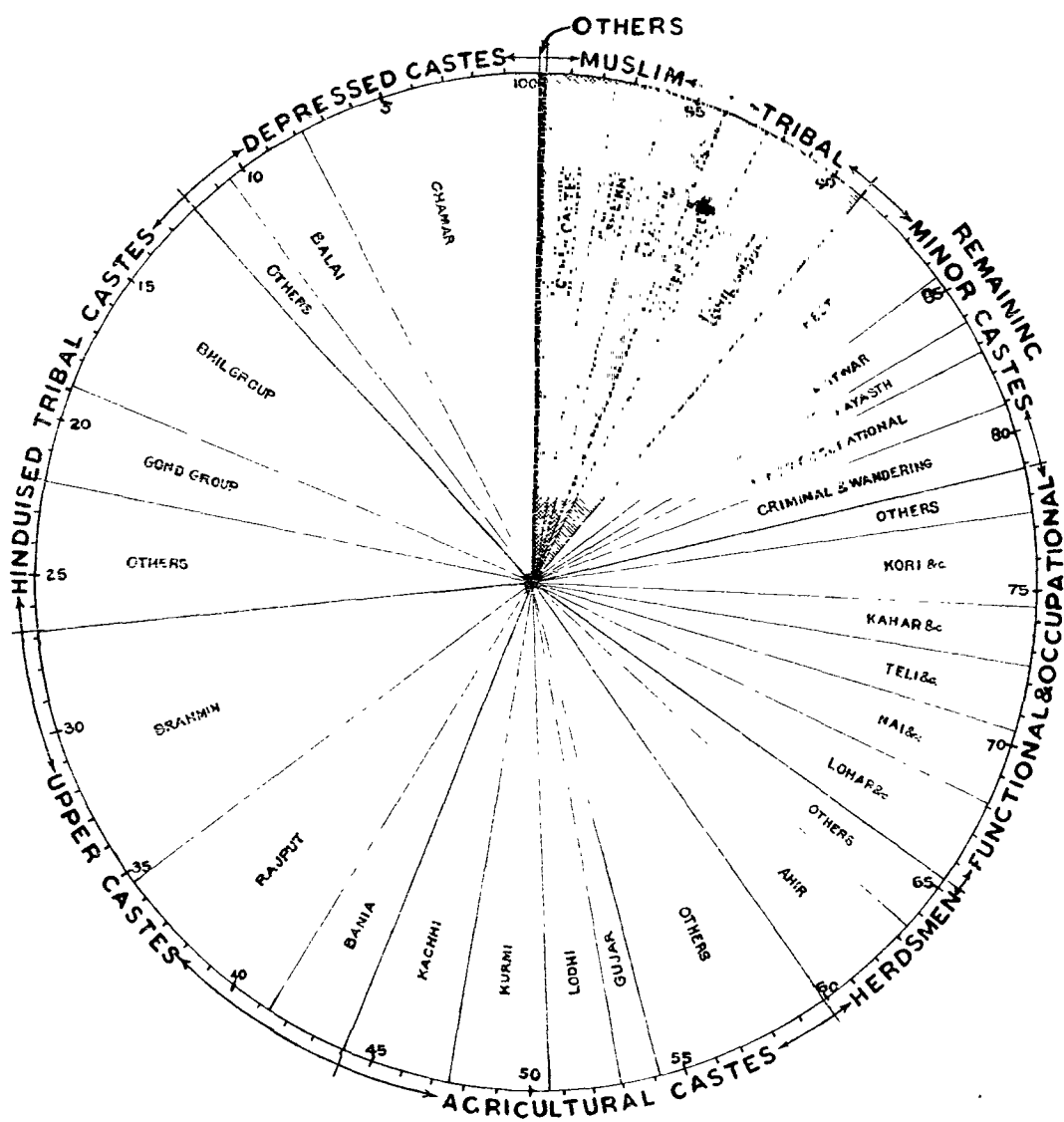

NOTE.

1. FOR DEFINITIONS SEE THE TABLES UNDER THE MAIN FIGURES, THE DEPRESSED CASTES AND THE FOREST AND HILL TRIBES.
2. THE SECTORS BEAR THE SAME PERCENTAGE WHICH THE STRENGTH OF A CASTE OR A GROUP NOTED THEREIN BEARS TO THE TOTAL POPULATION.

REFERENCES.

- HINDU & JAIN ----- □
- TRIBAL ----- □
- MUSLIM ----- ▨
- OTHERS ----- ■

of the tendency of the enumerator in recording the peculiar pronunciations and solecisms of the enumerated, embellished or mutilated as the case may be by the euphony of the enumerator. It is also possible that the true strength of the caste in some instances may not be as represented and an allied caste may appear as a separate entity.

In this Agency intentional errors are much less common than elsewhere where caste consciousness is more active and where aggressive claims are put forward as soon as people know that a Census is to be taken. Only in the case of the Rajputs in Central India there may be a tendency on the part of certain septs of doubtful affinity to pass off as true Rajputs. But little control can be exercised over this possible source of error. The Rajputs in Central India are a mixed lot and the history of the Rajputs in these parts is more responsible than any body else for the prevalence of many sub-divisions with the reputed Rajput affiliation.

Name of caste.	Title claimed.
1	2
Nai . . .	Brahman.
Bhat . . .	Brahma-Bhat-Brahman.
Kurmi . . .	Kurmi-Kshatriya.
Lodhi . . .	Lodhi-Rajput.
Chamar . . .	Jatav (Yadav).
Mali . . .	Rajput.
Khati and Sutar . . .	Jangida-Brahman.
Sutar and Lohar . . .	Panchal Brahman.
Khangar . . .	Khangar-Kshatriya.

In their long settlement in the plains and hills of Central India the Rajputs have not hesitated to take women from the lower castes or from the tribal ranks and by long usage many have gained admission some to spurious and some to genuine clanships. Apart from this there is no movement of any kind whereby the lower castes are advancing claims to be included among the higher castes. But a number of caste organisations having their head-quarters elsewhere sent out the usual applications some of which are summarised in the marginal table. These claims were not known to any body in Central India, and the caste entries did not reveal any of these new nomenclatures that were so persistently advocated by the various petitioning bodies. At present the Census in the States is looked upon with indifference and it excites no curiosity or rivalry or any feverish activity on the part of caste organisations which, as a matter of fact, do not exist at all. No question arises therefore as to how these claims were disposed of. Only in the case of the Brahma-Bhats they have been shown separately from the Bhats but not included under the Brahmans. Otherwise the Caste table is singularly free from the parvenu accretions to caste.

205. Caste Returns: Their utility.—In connection with the caste returns it is sometimes stated that they are of little utility, that under modern conditions caste restrictions are everywhere breaking and that insisting on caste returns the Census accentuates caste differences and encourages fissiparous tendencies already inherent in the system. The last of these charges against the Census is both unsound and unjust. It has been aptly remarked that a Census is, as it were, a snapshot of the population at a particular time. Its best and highest aim is to obtain a true and faithful picture. A camera may be blamed for not clearly photographing an object or for blurring the details but it cannot be blamed for reproducing an object which is already there. The Census enables us to see the different cross-divisions of the population and if any of them are not to our liking their presence cannot merely be ignored by laying a charge against the Census. Even if it be the caste system is breaking—more of that anon—information will still be necessary as to the process of its disintegration, the direction and form which it is taking, its effect on the cultural and social organisation of the people and on many other relevant matters. As regards utility much depends on the point of view from which the question is approached. Caste statistics are certainly necessary to study many of the sociological problems. They are required for ethnological research and above all the educationalist and the administrator would require them as for many years to come they will be dealing with people separated by wide cultural differences.

206. Main figures.—The distribution of the whole population of the Agency by caste, tribe or race is given in the marginal table and the diagram opposite shows the distribution of the different castes. The small number of 'Others' includes Sikhs, Buddhists, Jews, Zoroastrians and Christians numbering in all 12,929. They have already been noticed in sufficient detail in the previous Chapter. The Tribal group includes those primitive tribes who have returned

themselves under a tribal religion as well as a small number of certain other castes which have returned a tribal religion. The Hindu castes have been divided

Distribution of population by Caste, Tribe or Race.

Caste.	Percentage to total Hindu population (including Jain).	Percentage to total population.
1	2	3
I. Hindu (including Jain)	100.0	89.0
i. Depressed classes	13.5	12.0
ii. Hinduised tribal castes	16.6	14.8
iii. Artisan, functional and cultivating castes	39.0	34.7
iv. Other castes	11.5	10.2
v. Upper castes	19.4	17.3
II. Tribal (tribal returns only)	5.1
III. Muslim	5.7
IV. Others	0.2

into five broad sections. The depressed classes and the primitive tribes will be noticed separately. For the remaining social groups the subjoined table gives the details as to the composition of the group or groups together with the strength of each group. An appendix to this Chapter gives a brief caste glossary for some selected castes.

Caste and Religion.	Absolute strength in 1931 and percentage to total population.	Caste and Religion.	Absolute strength in 1931 and percentage to total population.
1	2	1	2
Hindu and Jain.		ARTISAN, FUNCTIONAL AND CULTIVATING CASTES—contd.	
UPPER CASTES	1,147,225	3. ARTISAN AND FUNCTIONAL—contd.	
i. Brahman	573,454	ii. Nai, etc.	156,509
ii. Rajput	388,942	<i>Nai</i>	94,464
iii. Bania	184,829	<i>Bari</i>	7,797
	17.3	<i>Dhobi</i>	54,243
	8.6	iii. Teli	139,672
ARTISAN, FUNCTIONAL AND CULTIVATING CASTES.	2,300,952	iv. Kahar, etc.	120,788
1. AGRICULTURAL	1,047,865	<i>Kahar</i>	38,506
i. Kachhi	223,857	<i>Bhoi</i>	12,292
ii. Kurmi	205,371	<i>Dhimar</i>	69,990
iii. Lodhi and Loda	154,681	v. Kori, etc.	197,871
iv. Gujar	84,794	<i>Kori</i>	90,727
v. Other castes	[379,162	<i>Bunkar</i>	8,122
<i>Dangi</i>	5.7	<i>Kumhar</i>	[99,022
<i>Deswali (Mina)</i>	45,064	vi. Other castes	93,885
<i>Dhakad</i>	[50,392	<i>Darzi</i>	1.4
<i>Jat</i>	34,283	<i>Kachera</i>	3,389
<i>Kalota</i>	28,135	<i>Beldar</i>	4,863
<i>Khali</i>	22,453	<i>Chhippa</i>	4,081
<i>Kirar</i>	64,649	<i>Patwa</i>	2,274
<i>Kunbi</i>	32,637	<i>Mochi</i>	2,541
<i>Mali</i>	42,116	<i>Kasera</i>	2,708
<i>Sirvi</i>	44,934	<i>Dholi</i>	9,126
2. HERDSMEN	358,939	<i>Maru</i>	1,472
i. Ahir	232,925	<i>Kandera</i>	3,269
ii. Others	126,014	<i>Lakhera</i>	3,892
<i>Gadaria</i>	1.9	<i>Lunia</i>	6,449
<i>Gaoli</i>	98,350	<i>Tamera</i>	1,584
<i>Ghosi</i>	12,385	<i>Rangara</i>	4,951
3. ARTISAN AND FUNCTIONAL	894,148	<i>Salvi</i>	3,396
i. Luhar, etc.	13.5	<i>Silawat</i>	3,884
<i>Luhar</i>	185,423	REMAINING MINOR CASTES	676,569
<i>Sunar</i>	2.8	I. CRIMINAL AND WANDERING	10.2
<i>Sutar</i>	69,192	Banjara	138,781
	47,866	Sondhia	2.1
	68,365	Bagri	41,855
		Moghia	53,322
		Nat	24,652
		Pasi	7,274
		Pardhi	4,445
			3,329
			3,904

Caste and Religion.	Absolute strength in 1931 and percentage to total population.	Caste and Religion.	Absolute strength in 1931 and percentage to total population.
1	2	1	2
REMAINING MINOR CASTES—<i>contd.</i>		REMAINING MINOR CASTES—<i>concl'd.</i>	
2. MINOR OCCUPATIONAL	124,959 1·9	5. REST	223,764 3·5
Kalal	47,957	Muslim	376,637 5·7
Barai	20,165	1. PATHAN GROUP.	124,507 1·9
Bharbunja	5,234	Pathan	93,794
Khatik (Chikwa)	10,678	Sayvad	25,785
Kewat and Mallah	40,925	Moghal	4,928
3. KAYASTHA, ETC..	68,741 1·0	2. SHEIKH	103,650 1·6
Kayastha	37,092	3. OTHER CASTES	148,480 2·2
Bhat	12,281	i. Behna	33,900
Charan	3,392	ii. Bohra	14,715
Maratha	15,976	iii. Jolaha	10,201
4. KOTWAR, ETC.	110,324 1·7	iv. Mewati	12,963
Kotwar	28,470	v. Fakir (Sain)	14,414
Panika	25,283	vi. Remaining castes	62,287
Khengar	19,678		
Bairagi	20,122		
Gosain	16,771		

CENTRAL INDIA AGENCY

SHOWING
THE PROPORTION OF THE DEPRESSED CLASSES
TO THE TOTAL POPULATION OF EACH PRINCIPAL STATE.

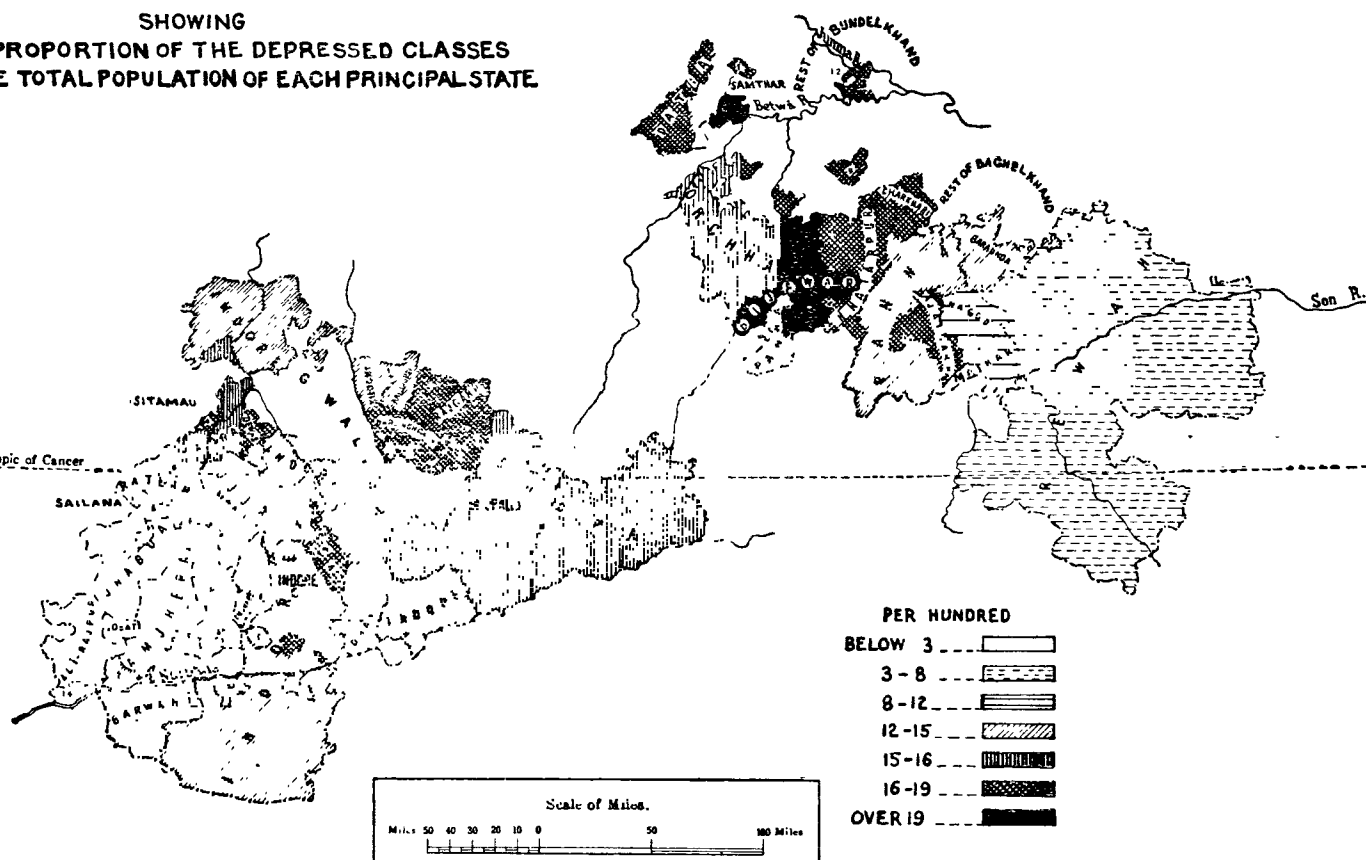

NOTE.—See Subsidiary Table III for detailed statistics.

207. Depressed Castes.—The castes shown in the margin have been listed as 'depressed' in this Agency. They form 12 per cent. of the total population and the map shows their distribution by States. The Balais are confined to

the south-west Vindhya. The other is the wild region to the south of Kaimur together with its extension to the plains to the north of Kaimur. Small patches of tribal areas are dotted all along the length of the Vindhya and the parts immediately adjoining the hill systems. We may distinguish four broad tribal areas. The first of these is the Bhil area. It includes the hilly parts of Sailana, Ratlam, Ali-Rajpur, Jhabua, Jobat, the minor States in the Southern States Agency, Barwani, the Nimar District of Indore and the hilly *mahals* of Dhar State. The Korku area is limited to a small portion in the Narbada valley and is just a thrust into Central India from the Satpuras. Above it is the Savara area. In the Malwa plateau this area strictly falls into the Sheopur, Isagarh, Narwar and Bhilsa districts of Gwalior. Further east in Bundelkhand a portion of Orchha, Panna, and other Bundelkhand States lie in this area. The last is the Kol-Gond area in Baghelkhand. Outside Baghelkhand the Kols and Gonds are found in small numbers in Panna and Ajaigarh but the Kols are not found in Malwa. Small numbers of Gonds are found in the Narbada valley principally in Indore and Bhopal where the Gond element like the Korku is an extension from the regions beyond the Narbada.

The classification of the tribes living in these areas has been arbitrary in the previous Censuses and at times the list adopted was in obvious disregard of the actual returns. On the present occasion a great amount of care was exercised in securing exact returns of the tribes from Rewa State where the tendency has been to return every one as Gond or to relegate the unfamiliar names to others. As far as possible many such have been rescued and correctly identified. In this Census we have been able to obtain a far more complete statistics for the primitive tribes than on any previous occasion. The primitive tribes of Central India may be divided into two main classes—Munda and Gond. To the latter we can assign Gond and Pathari. The former will have to be sub-divided into four groups, *viz.*, Bhil, Korku, Savara and Kol. The Bhil section includes in it (i) Bhil, (ii) Bhilala, (iii) Mankar, (iv) Patlia, (v) Barela, (vi) Nihal and (vii) Rathia. The Savara section includes Saharia, Sonr and possibly Kondar. The Kol section embraces Kol, Bharia, Bhumia, Baiga, Bemariha, Kawar, Khairwar, Mawasi, Pao and possibly Majhi. Owing to the penetration of the Gonds into the heart of the Kol area in Rewa, there is a mixture in some of the tribes and a completely accurate classification is not possible unless there is a systematic ethnographic survey of the Rewa tribes. The present classification is based on such meagre information as is available supplemented by the information relating to these tribes from the neighbouring parts. The following table shows the strength of the Hinduised and Tribal sections of the primitive tribes. The Hinduised sections of the Bhil and Gond groups form respectively 6.8 and 3.2 per cent. of the total population. The remaining Hinduised tribes constitute 4.8 per cent. of the total population. In the Tribal section the Bhil group is again the strongest as an individual group, forming 3.6 per cent. of the total population. The rest make up 1.5 per cent.

Tribe.	STRENGTH IN 1931.		Tribe.	STRENGTH IN 1931.	
	Hindu.	Tribal.		Hindu.	Tribal.
1	2	3	1	2	3
I. Bhil group.			IV. Kol group.		
1. Bhil	144,836	218,288	12. Kol	193,526	6,723
2. Bhilala	187,145	6,630	13. Mawasi	2,251	2,848
3. Barela	38,517	108	14. Baiga	30,914	4,899
4. Mankar	20,430	No returns	15. Bharia	23,530	460
5. Nihal	11,529	702	16. Bhumia	8,763	73
6. Patlia	8,268	11,140	17. Kawar	3,934	No returns
7. Rathia	37,260	No returns	18. Khairwar	6,382	214
II. Korku group.			19. Majhi	2,011	1,033
8. Korku	12,467	6,348	20. Pao	16,235	17
III. Savara group.			21. Bemariha	No returns	36
9. Saharia	2,926	1,492	V. Gond group.		
10. Sor (Sonr)	15,096	2,824	22. Gond	208,339	74,058
11. Kondar	3,296	No returns	23. Pathari	2,169	101

209. Further remarks.—Too much reliance should not be placed on the identification and classification of some of the tribes mentioned in the above table.

The Bhil group is capable of being identified fairly accurately. A detailed account of this group will be found in the appendices to the report and it need not detain us here. It is doubtful if the Korkus ever effectively penetrated into Central India. They are found in the Nimanpur *mahal* of Dhar State, the Nemawar district of Indore and the southern portion of Bhopal—all situated to the south of the Vindhya, in the Narbada valley. They are settled in the villages and have become village drudges like the lower castes. They are making a bid to claim admission to Rajput rank and point to Chitorgarh as the place from which they have migrated! In these parts they appear to have been ousted by the Gonds who held the Narbada valley till they in turn were subdued by the Muslims and the Marathas. The tribes of the Savara group are now completely submerged by the flood of successive migrations from the north. The open nature of the north Gwalior country could afford them no shelter as the Vindhya have done for other tribes. Further east the Sonr had found shelter in the hills but in recent times, in Orchha and Panna and other eastern States he has come to settle near the villages. The Kondar is possibly an occupational off-shoot of the Sonr tribe. These three have abandoned their original language and speak some form of Hindi. The Savars were once a widespread race and they are identified with Sabara a wild non-Aryan tribe mentioned in early Vedic literature. The identification of the tribes of Rewa is at present a difficult task owing to the absence of precise information and due to the penetration of the Gonds in this region. A certain number of tribes are no doubt of mixed origin and at present their constitution is of indeterminate nature. There is good reason to assume that the Kols were the dominant race in Rewa and even in the northern areas up to the Gangetic valley. The Gond thrust is of a later period and according to Russel and other observers in the Central Provinces the Gond invasion is in recent historical times. The Kol has long since lost his independence and individuality. He is now a degraded serf all over Baghelkhand. The Mawasis appear to have been a fighting section of the Kols and the term itself means a resident of the hill and forest. The inter-relations of Baiga, Bhumia and Bharia are yet to be definitely ascertained. Some identify Bharia with the Bhars—a well-known people of the Gangetic plain, closely allied to the Kols and Cheros, who have left a considerable tradition of their antiquity. The Bharias are also termed Bharia Bhumia. Then again the Baiga and the Bhumia are interrelated. The Bhumias are said to be of Munda origin and the Baiga appears to be derived from the Bhumia. Nothing is known about the Kawars of Rewa. Russel writes: 'It is probable that they belong to the Dravidian tribal family'. But this does not convey much meaning. There are differing accounts regarding the Khairwars. Dalton identified them with the Cheros while Crooke identified the Mirzapur Khairwars with Savars and Gonds. I should consider their ethnology to be doubtful. The name Khairwar itself is an occupational term and it denotes persons taking to the business of boiling catechu. Very possibly some may be of mixed origin but there is no doubt that a tribe called Khairwar or Kairwar is an aboriginal tribe inhabiting southern Rewa for a long time. The Baland Rajas of this tribe had held considerable sway in the neighbouring parts till the Chandels expelled them. Their descendants still reside in Marwas in southern Rewa. It is more probable that the Rewa Khairwars are of Kol origin rather than of Savara who have not extended so far into Rewa. Russel quotes an interesting description of them from Dalton's '*Ethnology of Bengal*'.

"There is in the seventh volume of the Asiatic researches a notice of Kharwars of the Kaimur hills in the Mirzapur district, to the north of the Son river, by Captain J. P. Blunt, who in his journey from Chunar to Ellora in A.D. 1794 met with them and describes them as a very primitive tribe. He visited one of their villages consisting of half a dozen poor huts, and though proceeding with the utmost caution, unattended, to prevent alarm, the inhabitants fled at his approach. The women were seen, assisted by the men, carrying off their children and moving with speed to hide themselves in the woods. It was observed that they were nearly naked and the only articles of domestic use found in the deserted huts were a few gourds for water vessels, some bows and arrows and some fowls as wild as their masters. With great difficulty by the employment of Kols as mediators, some of the men were induced to return. They were nearly naked but armed with bows and arrows and a hatchet".

The Majhis are another mixed lot. Some hold they are derived from the Kols; others think they are derived from the Gonds. The Paos are the most intriguing. They appear for the first time in the caste table. To the Rewa

observers everybody looks like a Gond and a short note furnished by the State describes them as resembling the Gonds. No such tribe is traceable in the Castes and Tribes of the Central Provinces. The only opinion that could be hazarded is that the Bhumias also describe themselves as *Pawan-ka-put*. Pao may be a shortened form of this appellation. In fact unless there is a complete survey of the tribes in southern Rewa, our knowledge about them is incomplete. It is next to impossible to get any information from this backward area and no accurate information is possible without a trained observer. The classification is practically based on the assumption that the dominant element is the Munda race in these parts and the Gond element is merely an intrusion in recent times.

210. Modern tendencies.—We have already mentioned the view that the Census should not concern itself with caste and that under modern conditions the caste system everywhere shows signs of disintegrating. Is the caste system really breaking? On a representation made by a society whose object is to secure the abolition of caste, the Government of India made the following interesting observation which was circulated to the enumerating agency for compliance:—

“In the case of all persons who have actively ceased to conform to the caste system and who have actively broken it in their marital or commensal relations, but who do not belong to reforming or schismatic communities, such as, the Arya Samaj or the Sikhs or Jains, a return of ‘nil’ will be both accurate and adequate and will be accepted by the enumerators particularly where they have personal knowledge of the accuracy of the householder’s reply”.

No one was forced to give his caste, if in fact he had none but everyone in this Agency gave some caste or other and not a single person returned his caste as ‘nil’. This in itself is significant to emphasise what a strong hold caste has on the Indian mind and thought. At the same time we cannot deny that modifications and changes are silently at work in softening the rigidities of the system. In urban centres and in certain advanced localities, under the stress of modern conditions, the institution of caste is undergoing much transformation and widely diverging from its time honoured and traditional path. Many persons no longer follow their traditional calling. Persons who have migrated to long distances away from their homes and their local caste environment are emboldened to throw away the shackles of caste customs. Fitful but nevertheless genuine movements awakening a more rational attitude towards the anti-social aspects of the system are also at work. Such good signs should be viewed apart and distinguished from the more unsubstantial and effervescent activities about which one hears or reads and they again are to be viewed as a portent of the coming adjustments in the society rather than as evidence of the breaking up of the caste system on which the society rests. It must be stated—however unpalatable it might be—that it has almost become a fashion for a certain section of the intelligentsia to assert an aggressive intellectual disbelief in certain socio-religious principles while meekly and tamely conforming to many of the outward conducts which form a part of their socio-religious system. Some believe in sounding the death-knell of the caste system and thereby regaining their loss of self-respect by burning the ordinances of that despised law-giver Manu. But such demonstrative actions may possess some value in the minds of some. The more substantial effort is the movement towards the active breaking up of restrictions in commensal and marital relations. Without in any way belittling all such efforts, it should be pointed out that what is happening is that the absurd rigidities of commensality and touch, in the present day conditions are being considered in a more practical light and under exceptional conditions in few cases and under enlightened and emancipated ideas in select instances, ideas regarding inter-marriages between the sometimes seemingly meaningless sub-castes are undergoing a rational change. It may even be that the actual forces at work may in time lead and take back the system to its somewhat elastic state before it attained its fixed rigidity. In the earliest phases of the caste system there is no evidence to show that contact with a lower caste causes pollution or it is against the caste canons to take food from a person of an inferior caste. Obscure has been the origin of caste in India. Whether it be that its germs were already present in the pre-Aryan India and it blossomed under the invigorating Aryan culture or whether it was brought into India by the Vedic Aryans, we are entitled to state that in its earlier development it owed a great deal to the working of the law of hypergamy and from the earliest times restriction on inter-marriages was one of the chief attributes of caste.

The Indian society is moored to this basic and fundamental idea of marital restrictions which the institution of caste enforces and there is yet no marked sign it has been cut adrift from it. Divorced from politico-religious outlook, it is but right that a system which has been the product of evolution and adaptation for a long time is not suddenly uprooted in the manner the zealous would have it. It cannot be violently replaced without permanently injuring the social structure. The pages of a Census Report cannot be turned into uttering prophetic warnings about the future of the caste system. We cannot say what mysterious course it will follow, assailed as it is on one side by the obscurantist forces of the conservatives who see in it nothing but divine immutability and on the other by the frenzy of the radical reformer to whom the very word is an anathema. No, the caste system is neither immutable nor is it tottering. So sympathetic an observer as Birdwood wrote that "so long as the Hindus hold to it, India will still be India; but from the day they break from it, there will be no more India—India of the Hindus. That glorious peninsula will be degraded to the position of a bitter 'East end' of the Anglo-saxon Empire, as were Shadwell and Limehouse and Bermondsey, of London, by the abolition of the Honourable East India Company, on September 1, 1858¹". Given, caste is still the basic force in Indian life, its future evolution may considerably be modified, amongst others by three important tendencies. The caste system has been imposed from the top. It is the higher and the highest castes, who have to surrender, if they wish, as they claim, to undo the pernicious effects of the system. As long as they cling to their privileged positions, the tendency among the lower castes would be to reach up to them. It is never palatable for those in the higher caste strata to be threatened by those who hitherto were condemned to low positions in life. As Aldous Huxley would put it, "people whose superiority is precarious detest with passion all those who threaten it from below²." Secondly false racial history requires to be replaced by sober and scientific ideas about Indian ethnology which will be a valuable corrective to caste pride and snobbery. This is by no means an easy task for even in European countries such superstitions like the superiority of the Nordic race are firmly rooted. In many parts of India the Aryan bodily type has either disappeared or submerged in other racial stratum though the culture and language remain. But not a few ethnic fictions still persist and as Risley pointed out the caste system itself is in some respects the product of fiction. Thirdly there is the influence of the Indian women when they become enlightened. We do not know what role they will play on the future life and thought of the country. At present they are the conservators and custodians of the old traditions. Men employ subterfuges and evade many a caste restriction but the core of the family is rarely affected by such practices. Were the women to refuse to believe in caste, revolutionary changes will sweep over the institution and who knows that at some distant date caste and outcaste may become the archaic words of a vanished past.

¹ *SVA* By Sir George Birdwood, edited by F. H. Brown, London, 1915, pages 318-19.

² *Jesting Pilate*.

SUBSIDIARY TABLE I.

Variation in numbers since 1921 in important castes, and the proportion of each such caste to the population of the Agency.

Caste.	1931.		1921.		Percentage of variation 1921-31.
	Persons 000's omitted.	Proportion per mille of the total population.	Persons 000's omitted.	Proportion per mille of the total population.	
1	2	3	4	5	6
Ahir	234	35	222	37	+5.4
Ajna	7	1	6	1	+8.2
Bagri	25	3	23	4	+5
Baiga	36	5	26	4	+35.3
Bairagi	20	3	29	5	-31.0
Balai	191	29	174	29	+1.2
Bania (including Jain)	185	28	179	30	+3.1
Agarwal (including Jain)	21	4	21	3	+13.9
Gahoi (including Jain)	15	2	15	3	-2.4
Kesar (including Jain)	14	2	14	2	-0.6
Mahesri (including Jain)	10	2	9	2	+9.4
Oswal (including Jain)	25	4	23	3	+8.1
Porwal (including Jain)	23	4	22	4	+6.5
Banjara	42	6	32	5	+31
Bansphor	43	7	40	7	+9.8
Beldar	5	1	5	1	+4.4
Bhangi (including Muslim)	31	4	23	3	+33.2
Bharewa	1	..	17	3	-91.9
Bharud	11	2	10	2	+11.5
Bhat	12	2	15	2	-16.3
Bhil (including Tribal)	363	55	338	56	+7.4
Bhilala (including Tribal)	194	29	170	28	+14.0
Bhoi	12	2	10	2	+25.5
Bohra	15	2	13	2	+10.0
Brahman	573	86	557	92	+2.93
Bhagor	11	2	11	2	-0.4
Dakshani	19	3	19	3	+0.8
Jijhotia	49	7	49	8	-1.1
Kanaujia	45	7	47	8	-5.0
Sanadhya	33	5	32	5	+4.3
Sarwaria	299	45	288	48	+3.8
Shrigaud	10	1	10	2	+2.0
Chamar	514	77	548	75	+14.6
Chhipa (including Muslim)	6	1	7	1	-7.9
Dangi	45	7	42	7	+7.8
Darzi	36	5	34	4	+5.6
Deswali	22	3	20	4	+7.8
Dhakad	34	5	32	5	+8.1
Dhimar	70	11	60	10	+17.0
Dhobi	55	8	49	8	+12.1
Dholi	9	1	9	2	-2.2
Gadaria	98	15	79	30	+25.2
Gaoli	12	2	14	2	-12.5
Gond (including Tribal)	282	43	247	40	+14.1
Gosain	17	3	10	2	+75.0
Gujar	85	13	75	13	+12.5
Jat	28	4	24	4	+16.2
Jogi	5	1	5	1	+3.0
Kachhi	224	34	208	35	+7.8
Kahar	39	6	43	7	-11.0
Kalal	48	7	45	8	+6.5
Kalota	22	3	18	3	+25.6
Kandera	3	..	3	1	+5.1
Kayastha	37	6	37	6	..
Kewat	36	5	30	5	+18.9
Khangar	20	3	18	3	+8.6
Khati	65	10	60	10	+7.0
Khatik (including Chikwa)	11	2	10	2	+5.3
Kirar	33	5	34	5	-3.9
Kol (including Tribal)	200	30	163	27	+23.0
Koli	92	14	88	11	+4.8
Korku	18	3	7	1	+25.8
Kotwar	29	4	28	5	+2.8
Kurmi	205	31	155	26	+32.4
Kumhar	99	15	85	14	+16.4
Lodhi	136	20	129	21	+5.4
Luhar (including Muslim)	71	11	62	10	+14.6
Majhi	3	..	2	..	+72.7
Mali	45	7	44	7	+3.3
Maratha	16	2	18	3	-10.1
Moghal	5	1	5	1	-9.2
Nai (including Muslim)	96	14	90	15	+6.2

SUBSIDIARY TABLE I—*concl'd.*

Variation in numbers since 1921 in important castes, and the proportion of each such caste to the population of the Agency—*concl'd.*

Caste.	1931.		1921.		Percentage of variation 1921-31.
	Persons 000's omitted.	Proportion per mille of the total population.	Persons 000's omitted.	Proportion per mille of the total population.	
1	2	3	4	5	6
Panika	27	4	24	4	+13.7
Pardhi	4	1	4	1	-4.2
Patlia	19	3	15	2	+31.7
Pathan	94	14	86	14	+9.7
Pinjara (including Behna and Naddaf, Hindu and Muslim).	35	5	11	2	+224.1
Rajput	389	59	394	66	-1.3
Baghela	23	3	23	4	+0.6
Bundela	11	2	10	2	+10.5
Chauhan	26	4	24	4	+4.7
Gahlot	15	2	14	2	+2.4
Kachhwaha	4	1	3	1	+18.9
Parihar	17	3	16	3	+4.7
Ponwar	22	3	22	4	+3.0
Parmar	5	1	21	4	-75.4
Raghubansi	14	2	25	4	-46.4
Rathor	21	3	22	4	-6.2
Solanki	12	2	11	2	+9.9
Tonwar	5	1	3	..	+82.2
Rawat	5	1	4	1	+28.2
Saharia (including Tribal)	4	1	4	1	+1.5
Sayyad	26	4	22	4	+18.7
Sheikh	104	16	104	17	-0.5
Sondhia	53	8	53	9	+0.8
Sor (including Tribal)	18	3	12	2	+50.5
Sunar	48	8	44	7	+10.0
Sutar	68	10	67	11	+2.0
Tamboli	20	3	19	3	+4.1
Teli (including Muslim)	141	21	121	20	+16.8
Europeans	2	..	4	1	-29.5
British subjects	2	..	3	1	-28.9
Others	-65.8
Anglo-Indians	1	+53.8

SUBSIDIARY TABLE II.
Distribution of Primitive Tribes.
(a) Central India West.

NOTE.—The figure below the actual strength shows the percentage to total population.

States.	Total strength of the primitive tribes.	BHIL GROUP.												OTHER GROUPS.		REMARKS (Details of other groups.)				
		TOTAL.		BHIL.		BHILALA.		BARELA.		MANKAR.		NIRAL.		PATILA.			RATHIA.		Hindu.	Tribal.
		Hindu.	Tribal.	Hindu.	Tribal.	Hindu.	Tribal.	Hindu.	Tribal.	Hindu.	Tribal.	Hindu.	Tribal.	Hindu.	Tribal.	Hindu.	Tribal.	Hindu.	Tribal.	
1	2	8	4	5	6	7	8	9	10	11	12	13	14	15	16	17	18	19	20	21
West	765,196 21.0	468,991	224,370	144,553	216,930	187,245	6,630	38,517	108	20,479	..	11,529	702	19,408	..	37,280	..	24,709	57,128	
British Pargana of Manpur	8,336 48.7	66	3,270	34	3,270	30	2	
Indore	226,420 17.1	187,110	19,720	50,609	18,721	75,946	189	38,517	108	10,369	..	10,874	702	795	12,107	7,483	
Bhopal	58,857 8.1	395	1,050	185	911	57	139	153	7,970	49,442	
Khitchipur	959 2.1	34	925	34	925	
Narsinghgarh	4,014 3.5	3,421	58	3,323	58	98	492	43	
Rajgarh	4,607 3.4	3,748	248	3,739	248	4	616	..	
Dewas States	5,868 3.8	3,030	2,820	2,242	2,636	325	184	463	2	16	
Jaora	2,883 2.0	1,023	1,860	1,023	1,860	
Ratharn	32,441 30.2	2,645	29,782	2,645	29,782	14	
Sallana	13,401 38.3	881	12,610	866	12,610	15	
Sitaman	251 0.9	251	..	251	
Southern Central India States Agency.																				
All-Rajpur	88,881 87.1	87,511	1,370	29,957	1,130	53,088	240	646	3,825	
Barwani	89,015 59.5	65,258	18,665	6,960	18,665	16,635	4,395	37,280	
Dhar	86,497 35.5	61,242	22,085	29,421	22,607	25,265	28	4,533	..	502	..	1,521	3,078	142	
Jhabua	119,629 82.2	15,137	104,486	2,274	98,643	646	5,843	12,217	6	..	
Jobat	17,346 88.6	17,831	15	7,841	10	9,966	5	24	
East of Central India West	15,301 25.4	9,421	5,454	3,149	5,454	5,190	2	47	1,085	424	..	

SUBSIDIARY TABLE II—contd.
Distribution of Primitive Tribes—contd.
(b) Central India East.

NOTE.—The figure below the actual strength shows the percentage to total population.

States.	Total strength of the primitive tribes.	TOTAL.		KOL.		BAIGA.		BHARIA.		BHUMIA.		BEMARHA.		KAWAR.		KHAIRWAR.		MAWASI.		PAO.			
		Hindu.	Tribal.	Hindu.	Tribal.	Hindu.	Tribal.	Hindu.	Tribal.	Hindu.	Tribal.	Hindu.	Tribal.	Hindu.	Tribal.	Hindu.	Tribal.	Hindu.	Tribal.	Hindu.	Tribal.		
1	2	3	4	5	6	7	8	9	10	11	12	13	14	15	16	17	18	19	20	21	22	23	24
East	551,998 17.6	286,876	16,323	193,317	6,723	30,914	4,899	23,530	460	8,763	73	..	36	3,834	..	5,923	214	2,011	1,033	2,249	2,868	16,235	17
<i>Bundelkhand Agency.</i>																							
Ajagarh	7,455 8.7	4,316	192	1,731	1,514	127	944	192
Baoni
Bijawar	3,550 3.1
Chuarbari	1,274 1.1	832	..	220
Chhatarpur	2,364 1.5
Datia	451 0.3
Orchha	10,837 3.4
Panna	26,660 12.6	10,238	..	2,950	6,722	560
Santhar	113 0.3
<i>Baghelkhand Agency.</i>																							
Baraundha	3,021 18.8	164	2,025	..	586	11	131	22	1,439
Kothli	3,832 17.9	43	2,500	27	1,770	21	16	709
Maihar	12,780 18.5	8,571	..	7,641	927	3
Nagod	8,362 11.2	6,119	..	5,957	114	48
Rewa	404,672 29.3	256,226	7,572	174,510	801	30,914	4,809	22,489	460	516	73	..	30	3,934	..	5,013	103	2,011	1,033	4	..	16,235	17
Sohawal	4,010 9.5	101	3,118	181	2,944	10	174
Rest of Central India East	1,957 2.0	176	916	100	592	1	75	354

SUBSIDIARY TABLE II—concl'd.
Distribution of Primitive Tribes—concl'd.
(b) Central India East.

NOTE.—The figure below the actual strength shows the percentage to total population.

States.	SAVARA GROUP.												REMARKS (Details for Gond and Bhil Groups.)
	TOTAL.		SAHARIA.		SONER.		KONDAR.		GOND GROUP.		BHIL GROUP.		
	Hindu.	Tribal.	Hindu.	Tribal.	Hindu.	Tribal.	Hindu.	Tribal.	Hindu.	Tribal.	Hindu.	Tribal.	
1	25	26	27	28	29	30	31	32	33	34	35	36	37
East	18,476	2,749	888	..	14,992	2,749	3,296	..	202,879	22,456	281	1,358	..
<i>Bundelkhand Agency.</i>													
Ajagarh	270	270	..	2,815	358	1	33	Bhil Group.—Bhil H. 1 T. 33 ; Gond Group.—Gond H. 2,315 T. 358.
Baoni
Bhawan	503	2,612	2	2,612	501	435	Gond Group.—Gond T. 435.
Charkhari	250	94	..	156	..	192	Gond Group.—Gond H. 192.
Chhatarpur	2,055	659	..	1,896	..	231	..	78	..	Bhil Group.—Bhil H. 78 ; Gond Group.—Gond H. 231.
Datia	451	..	446	5
Orcha	9,149	137	329	..	8,802	137	18	..	141	6	165	1,239	Bhil Group.—Bhil H. 165 T. 1,239 ; Gond Group.—Gond H. 141 T. 6.
Panna	5,046	4,362	..	684	..	11,876	Gond Group.—Gond H. 11,876.
Samthar	113	..	113
<i>Baghelkhand Agency.</i>													
Baraunha	832	Gond Group.—Gond T. 832.
Kotli	27	1,262	Gond Group.—Gond H. 27 T. 1,262.
Malhar	4,161	48	Gond Group.—Gond H. 4,161 T. 48.
Nagod	2,243	Gond Group.—Gond H. 2,243.
Rewa	266	266	..	182,185	18,300	37	86	Bhil Group.—Bhil H. 37 T. 86 ; Gond Group.—Gond H. 180,016 T. 18,199, Pathari H. 2,169 T. 101.
Sohawal	701	Gond Group.—Gond T. 701.
Rest of Central India East	373	373	8	514	Gond Group.—Gond H. 8 T. 514.

SUBSIDIARY TABLE III.

Distribution of Depressed Classes.

NOTE.—The figure below the actual strength shows the percentage to total population.

State.	Total strength of depressed classes.	Chamar.	Balai.	Bansphor (Basor).	Bhangi (Mehtar).	Others.	REMARKS. (Details of others.)
1. British Pargana of Manpur .	374 (5.5)	99	205	14	48	8	Bhambi.
2. Indore	175,110 (13.3)	60,356	97,849	1,390	8,436	7,079	Bhambi—2,880 ; Dher—30 ; Jhamral—803 ; Mahar—2,269 and Mang—1,097.
<i>Bhopal Agency.</i>							
3. Bhopal	111,279 (15.2)	67,834	33,291	5,875	4,161	118	Bhambi—10 and Mahar—108.
4. Khilchipur	6,354 (13.9)	4,530	1,560	47	182	35	Bhambi.
5. Narsinghgarh	20,542 (18.0)	13,739	5,726	295	733	49	Bhambi—46 and Meghwal—3.
6. Rajgarh	24,449 (18.1)	18,584	4,677	362	826	..	
<i>Mahwa Agency.</i>							
7. Dewas States	25,769 (16.8)	8,397	15,647	92	854	779	Bhambi—619 ; Mahar—129 and Mang—31.
8. Jaora	15,202 (15.2)	7,082	6,628	..	737	755	Bhambi—580 and Mahar—175.
9. Ratlam	7,541 (7.0)	2,785	3,162	10	884	700	Bhambi—642 ; Mahar—46 and Mang—12.
10. Sailana	2,584 (7.3)	1,013	1,263	..	175	133	Bhambi—89 and Mang—44.
11. Sitamau	4,330 (15.2)	1,978	1,921	..	254	177	Bhambi—168 and Mahar—9.
<i>Southern Central India States Agency.</i>							
12. Ali-Rajpur	2,212 (2.2)	629	754	..	635	194	Bhambi—7 ; Jhamral—128 and Mahar—59.
13. Barwani	8,231 (5.8)	921	4,234	..	402	2,674	Bhambi—159 ; Jhamral—365 ; Mahar—940 ; Mang—9 and Meghwal—1,201.
14. Dhar	20,222 (8.3)	4,641	12,588	191	1,206	1,596	Bhambi—1,169 ; Jhamral—191 ; Mahar—140 ; Mang—46 and Meghwal—50.
15. Jhabua	2,012 (1.3)	1,305	412	..	161	134	Bhambi—15 and Meghwal—119.
16. Jobat	447 (2.2)	192	211	..	31	13	Jhamral.
<i>Bundelkhand Agency.</i>							
17. Ajaigarh	13,920 (16.2)	12,178	..	1,333	409	..	
18. Baoni	4,316 (22.6)	3,490	3	798	25	..	
19. Bijawar	22,996 (19.8)	19,522	..	3,134	340	..	
20. Charkhari	22,477 (18.7)	19,315	..	2,883	279	..	
21. Chhatarpur	29,580 (18.3)	24,851	..	3,914	774	41	Domar.
22. Datia	30,042 (18.9)	25,777	..	2,831	1,434	..	
23. Orchha	49,683 (15.8)	41,515	..	7,114	1,033	21	Dher.
24. Panna	30,406 (14.3)	26,123	..	3,216	1,067	..	
25. Samthar	6,550 (19.6)	5,432	..	884	234	..	
<i>Baghelkhand Agency.</i>							
26. Baraundha	1,812 (11.3)	1,649	..	6	157	..	
27. Kothi	2,870 (13.4)	2,323	..	132	14	401	Domar.
28. Maihar	6,013 (8.7)	5,497	..	488	28	..	
29. Nagod	8,577 (11.5)	7,900	..	507	170	..	
30. Rewa	112,578 (7.1)	97,167	66	5,607	3,850	5,888	Bhambi—4, Dhirkar—4,850 ; Dom—51 and Mahar—983.
31. Sohawal	6,312 (15.0)	6,061	5	25	221	..	
Rest of Central India Agency .	25,576 (15.0)	21,012	992	2,251	1,133	188	Bhambi—129 ; Jhamral—19 ; Mahar—27 and Mang—13. ¶

APPENDIX.

Caste Glossary.

1. **Ahir.**—The Ahirs are the sixth caste in point of number in Central India. They are mainly concentrated in the Bundelkhand and Baghelkhand States and also in the Bhopal Agency. They have not spread on the Malwa plateau but are found in considerable numbers to the south of the Vindhya in Barwani and in the Nimar district of Indore. The Ahir element is an extension to these places from the Khandesh district. They have increased by 5.4 per cent. during the decade. The strength of the caste is liable to variation as certain number must have been included in the allied caste of Gcala.

2. **Bagri.**—The strength of this caste is 24,661. This caste is also known as the Moghias and 7,429 have returned themselves as such. The Bagris or Moghias are a well-known tribe of thieves and dacoits and the unsettled nature of the country a century ago was highly congenial to their predatory habits. A brave race of men, they were employed as foot-soldiers for purposes of protection in that period of weak rule and anarchy in Central India. They have now been weaned away from their habits and settled in different parts of Central India as agriculturists. The Bagri or Moghia is now a poor creature compared with his forebears. "Ours has been a *badshahi kam*—an imperial trade", said one of them to General Sleeman, "we have attacked and seized boldly the thousands and hundreds of thousands that we have freely and nobly spent. We have been all our lives wallowing in wealth and basking in freedom and find it hard to manage with the few copper pice a day we get from you".¹ They claim that they were originally Rajputs. Centuries ago the daughter of a Rajput chief of Gujarat was being escorted by some Rajputs to Delhi to be given as a bride to one of the Muslim kings of Delhi. On the way the party encamped at a *Baori* (a well with steps) and the princess committed suicide by falling into the well presumably to save herself from the disgrace of entering the *harem*. The party did not proceed to Delhi and out of shame they did not retrace their steps. They settled down at the place of encampment and took the women who had accompanied the princess for their wives. The colony took to plundering for their profession and when it grew large, they scattered all over. One branch returned to Rajputana and called themselves Baoris (from the word *Baori* in which the princess fell) and they acquired the appellation of Bagri or Moghia according to the localities in which they settled. One version of the origin of the Moghias is that the Rajputs who took the low caste women became separated into Moghias while the others became Baoris. Another version is that the chief of Mewar complimented that they were as precious as 'Moongas' (coral beads) when they rendered service to him in suppressing a band of Bhils and Minas. Moghia is said to be a corruption of Moongias. Their family names still correspond with those of Rajputs, e.g., Chauhan, Solanki, Panwar, etc. It is stated that each sept has its own sacred tree, the Chauhan the *Asapala*, the Rathors the *Nim*, the Solankis the *Am* (mango) and the Bhatias the *Khejra*. The last sept never cuts this tree nor injures it, oaths are taken by it and no woman ever passes below it. As a wandering people they have retained the habit of eating meat but they abstain from taking fowl. They worship goddesses *Seeta* and *Kalika*. The ceremony of marriage among them is just like that of the Rajputs. Marital ties are loose. A woman can run away and live with another man, the husband being entitled to a sum fixed by the *panchayat*.

3. **Baiga.**—A primitive tribe exclusively enumerated in Rewa. Their true strength is never recorded as they get mixed up with the Gonds in south Rewa and also their exact affiliation with certain allied tribes like the Bhumia, Bharia and Bemariha is not yet known. The Baigas are also known as Bharias in Rewa and in the adjoining districts of the Central Provinces. Bhumia is another name for a Baiga. It was found difficult to secure any detailed information about these tribes from Rewa State but from the brief notes supplied it is certain that the Baigas are a very primitive tribe. In southern Rewa they lead an independent and isolated life and prefer not to live in villages but take their abode in inaccessible hilly tracts. They are shy of strangers. Formerly they used to practise shifting cultivation extensively by cutting a portion of the forest and utilising the plot to sow some wild food grains. It is now reported the State has stopped the practice. The produce raised by this method of cultivation is sold in the *Bazaar* and the Baiga utilises the proceeds in buying salt and tobacco. Their huts are perched on the summits of the hills in clusters of three or four. If any animal is killed, it is roasted and eaten then and there. If the prey is a big one it is taken home, dried up and preserved for the rainy season. The Baiga subsists on forest produce and is a clever and fearless hunter. The male Baiga is scantily dressed while the female wears *dhoti*. He does not indulge in the luxury of shaving more than 2 or 3 times in a year. A

¹ *Serious crime in an Indian Province*, Eustace J. Kitts, B.C.S., Bombay, 1889, 76.

Baiga has no knowledge of any date, month or year and marriages are celebrated at will. The dead bodies are burnt but no funeral rites are performed. The more civilized Baiga lives like a Gond from whom he is rarely distinguished by the Rewa people. Forsyth in his *Highlands of Central India* wrote about them :

“ Destitute of all clothing but a small strip of cloth, or at most, when in full dress, with the addition of a coarse cotton sheet worn cross-wise over the chest, with long, tangled, coal black hair and furnished with bow and arrow and a keen little axe hitched over the shoulder, the Byga is the very model of the hill aborigine. He scorns all tillage but the dhya-clearing on the mountain side, pitching his neat habitation of bamboo wicker-work, like an eagle's eyrie, on some hill top or ledge of rock, far above the valleys, penetrated by path ways ; and ekes out the fruit of the earth by an unwearying pursuit of game. Full of courage and accustomed to depend on each other, they hesitate not to attack every animal of the forest, including the tiger himself. . . . There is every reason to believe that these Bygas are, if not autochthonous, at least the predecessors of the Gonds in this part of the hills. They consider themselves, and are allowed to be, superior to the Gonds, who may not eat with them and who take their priests of the mysteries or medicine men, among them ”.

The Baiga is a great sorcerer and the Baiga charmer's most dangerous duty is that of laying the spirit of a man who has been killed by a tiger. Forsyth gives an interesting description :

“ The Byga has to proceed to the spot where the death occurred, which is probably still frequented by the tiger, with various articles such as fowls and rice, which are offered to the manes. A pantomime of the tragedy is then enacted by the Byga, who assumes the attitude of a tiger, springs on his prey and devours a mouthful of blood-stained earth. Eight days are allowed to pass ; and should the Byga not, in the interval, be himself carried off by the tiger, the spirit is held to be effectually laid and the people again resort to the jungle. The theory rests on the superstition, prevalent throughout these hills, that the ghost of the victim, unless charmed to rest, rides on the head of the tiger and incites him to further deeds of blood, rendering him also secure from harm by his preternatural watchfulness ”.

4. **Balai.**—An impure caste of village watchmen found only in Malwa. They are considered to be untouchables and live on the outskirts of the village. They have no tradition of migration and in all probability are the subjugated aborigines of Malwa and form the earliest strata of the population. From time immemorial the Balai has been the village watchman and drudge. In the old village constitution he was a very important village officer and an authority on the village boundaries and everything pertaining to the village. He was ‘ *ca-officio*, the Patail's spy ’. Next to the Chamar, the Balai is numerically strongest amongst the depressed classes and forms 2·8 per cent. of the total population.

5. **Bania.**—The total strength of the Bania caste is 184,829 out of which 50,268 are Jains. Amongst the important sub-castes the most numerous are the Oswals who are mostly Jains (Hindu 2,953 ; Jain 22,304) and they are closely followed by the Agarwals. The Oswal, Porwal and Agarwal sub-castes are distributed all over the Agency. Three other sub-castes Golapurab, Kasaundhan and Kesar are confined to the eastern parts while the Kharia sub-caste is found only in Rewa. The Mahesri Banias are exclusively confined to Malwa States. The Bania group forms 28 per mille of the total population and has increased by 3·1 per cent.

6. **Banjara.**—This is a well-known caste of carriers and drivers of pack-bullocks. Their strength is 42,097 and have increased by 31 per cent. They are distributed in all the States of western Central India. The Banjaras in Malwa are divided into three endogamous subdivisions, *viz.*, (i) Labana, (ii) Bamnia Bhat and (iii) Rajput Banjaras. Their caste structure which includes the names of several well-known Rajput clans like Kachhwaha, Rathor, Chauhan, etc., shows that they are in part derived from the Rajputs. The caste organisation is presided over by a headman called *Naik* and their caste *panchayat* exercises considerable control over the members, prescribing penalties for offences like adultery, etc. Petty disputes and offences are disposed of by the *panches* of one village and more heinous offences are decided by the joint *panches* of 12 villages. Besides the murder of a human being, killing of a cow or of an ox, or cat or of a dog, are considered as heinous offences. For these murders the accused is exiled for a month and a quarter and his family ex-communicated. They are even denied access to the general well. The accused person is not allowed to shave during the period of banishment and the Dhobi is not allowed to wash his clothes. In case the culprit is sent to jail for committing any of the offences cognizable by the *panchayat* also, he will have to feed a certain number of people after his release from jail. Formerly they used to transport articles on pack-bullocks from place to place and were famous for their commissariat work in the fighting days of old. The railways have ruined their occupation and they have now settled down in different parts of the country and have taken to cattle breeding and agriculture.

The Bamnia Bhat Banjaras give the following story of their origin :—

Two Rajputs were in the service of the Moghal emperor, but were disgraced for attempting to seduce a Musalman woman, and fled into Rajputana. While hiding in the jungles the Rana of Udaipur came out hunting. Being thirsty he sent a servant to seek water. The servant fell in with the brothers from whom he obtained some cold water, after hearing that they were Rajputs. The king on receiving the water asked whence such cold water was obtained in the jungles, and on being told set out to see the brothers. They were afraid and on his appearing said they were Bhats not Rajputs, and Bhats are always protected by Rajputs. The Rana then took them to the capital and gave them the village of Bamnia in Jagir. All their protestations as to their being Rajputs in reality were unavailing, and they were outcasted and prohibited from marrying with Rajput women. They thus lost status. Later on a descendant Rupa Naik took to plundering, the Jagir was confiscated, and they became carriers of merchandise. The extension of railways and roads has forced most of them to take to agriculture. They used to carry salt from Pachhadra and sell it in all parts of India. They started out in *Bhadon* returning in *Jeth* (September to May). Bamnia is still recognised as their head quarters although the hills of Rampura form their real home. At Bamnia stands the Chatri of Rupa Naik to which members of the clan go and pray for the fulfilment of their vows. Descendants of Rupa's family are still considered as the leaders of the clan, and half the value of fines imposed by *Panchayats* are still paid to them.

They worship all Hindu gods and especially Guru Baba Nanak, well known by the name of *Rameshwar Gadi* because he is regarded as the originator of the occupation pursued by them. They also worship *Seva Maya*.

Another section of the Banjaras—the Multani Banjaras—are Muslims. They say they have come from Multan in the Punjab and they have a tradition that formerly they were Saraogi *mahajans* of Multan. They were later converted to Islam and became Multani Banjaras. They used to worship all Hindu deities and now they propitiate only *Pir Sahib*. The *Kazi* performs the *nikah* ceremony. They bury their dead. The head is placed to the north and the feet to the south. The mourners drop pebbles into the grave.

7. **Bansphor (Basor).**—The Basors are found in the largest number in the States of Bundelkhand and Baghelkhand Agencies. They are also to be met with in the Bhopal Agency States. They are considered to be untouchables. One section of them eats the leavings of others. They have a mythological origin of their caste. When Raja Yudhishtara performed a sacrifice the fire could not be put down by the Rishis present. Help was sought of *Shwapach* (a man of low caste, a *Chandala*) whose mere ringing of a bell extinguished the fire. It was then said, "*Shwapach hita ghanta baja ghate Rishin ke man*", i.e., (The bell rang for the sake of *Shwapach* and the pride of the Rishis was broken). The Raja then prepared milk and rice with the milk of a bitch. *Shwapach* was asked to eat but he refused. Through jealousy the Rishis ate. *Shwapach* went without food. Hard pressed by hunger he licked the leavies from which the Rishis had taken their meals. Since then the descendants of *Shwapach* became Basors. The sole occupation of Basors is to split bamboo and make baskets out of them. Their women act as midwives. Brahmans do not go to perform their marriages. In Bundelkhand a look at the Pole Star which is regarded as auspicious is generally resorted to at the marriage time.

The Jhamrals are a small localised group of Basors in the Nimar portion of Malwa, divided into two endogamous sub-divisions. They are here probably derived from the Vindhyan Bhils. The *panch patel* of the caste officiates as the priest and the marriage ceremony consists of giving seven turns round a stick 2½ feet high fixed in the centre of the marriage shed. They either burn or bury their dead. When interred the body is placed in a sleeping position with the feet towards south and head to the north. The Dhirkars of Rewa are another localised group. They are workers in reeds and canes and are considered as untouchables.

8. **Bargunda.**—A wandering caste of basket makers enumerated principally in Indore and the Malwa Agency States and also in the States of Bhopal, Dhar and Barwani. There were no returns from the eastern parts of the Agency. In Malwa this caste is known as Bargunda while in the Central Provinces and in Bombay it is known as Kaikari. Their main occupation is the making of mats, brooms, etc., of date palm leaves and baskets of palm (*Khajur*) sticks. The caste has no tradition of its origin and it has no definite idea as to when it settled in Malwa. Their language includes a large number of Tamil words and it is very likely they have drifted away somewhere from the south of India. In the various parts of Malwa where they are scattered they have become naturalised and have adopted the mode of living, dress, customs, and manners of the local lower castes. They have forgotten their songs of tradition. The Bargundas eat flesh of every kind except that of cow as it is held sacred and they consider themselves superior among the classes who eat refuse of food thrown away. They do not eat flesh of dead animals as Chamars do. The Bargundas are expert in catching *Goyara*, a kind of large lizard, believed to be very poisonous. They are said to eat the *Goyaras* as the Kalbelias eat the snakes they catch. It is not known how far this is a fact as even the breath of a *Goyara* is popularly believed to be so poisonous as to cause a cow to go blind and a *Goyara* on a *Pipal* tree is believed to draw lightning on to the tree to cause its destruction. Hence the vernacular saying '*Goyara ke pap se pipal jale*'. Their marriage ceremony lasts for 3 days and the remarriage of widows is allowed with this restriction that a bachelor is not permitted to marry a widow. They worship the lower deities of Hindu pantheon and believe in devils and other evil spirits. They burn their dead and observe mourning for three days only.

The strength of this caste as shown in the caste table is 2,665. 1,273 persons were returned as speaking Bargundi dialect which according to linguistic classification is assigned to Tamil. The Kaikaris of Central Provinces speak a gypsy language which according to the specimens collected contains a mixture of Tamil and Telugu words. A specimen of few words and sentences spoken by the Bargundas of Ratlam is given in an appendix to chapter X.

Their social position is low and in Central Provinces their touch is considered to defile a Brahman, Bania, Kalar and other castes but not a Kunbi. In Bombay they rank below Kunbi but above the impure castes. In Ratlam, they are considered untouchables but elsewhere in Malwa their untouchability is doubtful. I have excluded them from the list of untouchables for the Agency.

9. **Beldar.**—This caste includes a number of occupational groups of diverse origin and is an extremely doubtful caste entry. This generic term covering different castes includes those who work as masons or navvies. The caste of Mudaha returned from Rewa and other Baghelkhand States (7,140), an off-shoot of the Bind tribe who build the earthen embank-

ments of *bandhs* or tanks, and a small number of Vaddars (281) returned from Indore and Od or Orh should also be affiliated to the Beldar caste.

10. **Bhat.**—Bhats are bards and genealogists. Their strength is 12,378 and are distributed all over the Agency but are found in considerable numbers in Rewa and Indore. They are also known as Rao in Bundelkhand and one class of Bhats are known as Dasaundhi or Jasaundhi (282). One section of the Bhats appear to have been derived from the Brahmans and they style themselves as Brahma-Bhatta and are beginning to form a separate class claiming a distinct and separate place in the Caste table. In this Census their claim has met with recognition and they have been shown separately from the Bhats. Allied to the Bhats is the caste of Charans (8,122), almost certainly derived from the Rajputs. Malcolm says that the Bhats as chroniclers or bards, share power and sometimes office with the Charans and they enjoy great influence with the Bhilalas and other lower tribes. Those who are not liberal or treat the Bhats properly used to be visited with the wrath of a Bhat who would fix the figure of the person he would like to degrade on a long pole and append a slipper to it as a mark of disgrace.¹ The image would usually travel the country till the person infamed would purchase the cessation of ignominy and ridicule. The tradition of the origin as given by Malcolm goes to suggest that the Bhats are derived from the Brahmans and the Charans from the Rajputs. The Bhats have decreased by 16·3 per cent. as a considerable number have returned themselves as Brahma-Bhatta.

11. **Bhil.**—See Appendix I to the Report.

12. **Bhurtia.**—A caste numbering 2,113 returned from Rewa. Bhurtia appears to be no separate caste but an appellation under which a section of the Ahirs in Rewa are known. Some Ahirs who were wealthy in virtue of possessing large herds of cattle came to be known as Bhurtia which is probably derived from *Bhuti* meaning riches. Their manners, customs, usages and mode of living are akin to those of the Ahirs.

13. **Biar (Bayar).**—A small caste numbering 1,092 returned from Rewa. This is the first time they figure in the Caste table. They are found in the *pargana* of Rewa and also in the neighbouring United Provinces districts of Mirzapur and Benares. They rear cocks and pigs and follow agriculture and field labour as their occupation. They appear to be a mixed caste with some Hindu blood in them. The Rajputs engage them as watermen and domestic servants and this recognition by the higher castes has given them some status. They get the privilege of engaging a *Purohit* in their birth rites and a *Mahabrahman* for the funeral ceremonies. They worship ghosts and spirits but recently in contact with Gosains they have begun to propitiate Shiva also. They offer wine, cocks and pigs in sacrifice to their deities. Their children get married at the early age of 9 or 10 years. The marriage is settled by paying few rupees to the girl's father.

14. **Brahman.**—The Brahman group is numerically the strongest as a single caste and numbers 573,454. It forms 86 per mille of the total population. Of this, a little over one half (299,022) are the Sarwaris found mainly in Rewa and to a lesser extent in the other eastern States. The Jijhotia and Kanaujia Brahmans are mostly in Bundelkhand States. The Brahman 'forms a stratified cone which penetrates' the Hindu society 'vertically from top to bottom'. In Central India the two great territorial groups of Brahmans overlap. The Brahmans of central doab, the Kanaujia and the Sarwaria, belonging to the northern group and the Maharashtra and the Gujarati Brahmans belonging to the southern group have been drawn into the central regions by migrational currents.

15. **Criminal tribes.**—It is difficult to obtain correct statistics for the Criminal tribes as they return themselves under different names. They are an extremely elusive group. Besides the Bagris and the Moghias who have been noticed separately, four castes are given in the margin who are known to be criminal tribes.

Tribe.	Strength in 1931.
1	2
Bedia	2,873
Kanjar	683
Mewati	12,978
Sansi	682

Other wandering castes like the Pardhi, Nat or Kalbelia and settled castes like Mina or Sondhia who were once robbers are considered to be criminal tribes in different localities. The Bedias and the Sansis are closely allied. The former are divided into Bhanmata Bedia and Nut Bedia. The males are generally engaged in agriculture. Unmarried girls carry on singing and dancing and

indulge in free sexual license. Illegitimate children form a class by themselves and marry in that group. Unmarried girls who lead a dissolute life are known as Kasbis and put on light trousers and skirts. Bedias burn their dead and observe Hindu rites and ceremonies. The sister's husband acts as a priest on occasions of marriage. The Sansias originally came from Muttra where they are known by the name of Bedia. They first migrated to Udaipur and from thence have come to Central India. They live mostly under canvas though in settled life they make huts with thatched roof. They are exclusive by nature and do not admit out-

¹ *Memoir*, ii, 137.

siders. They have got different groups and marriage between members of the same *gotra* cannot take place nor can the children of a brother and sister marry. The maternal uncle plays the rôle of a priest in their marriages. The elder brother's widow can be taken by the younger brother for his wife. Both cremation and burial are practised. They worship the goddess of Nagarkot and use pigs for sacrificial purposes as an offering to their household deities while goats are offered to other deities. A class of criminal tribes who escape the Census net are the Sanorias also known as the Chandravedis. They have their home in Datia and Orchha. Originally derived from two Sanadhya Brahmans this caste was recruited from all classes excepting the Chamar. There was once a large colony of them in Orchha. It is stated that the name Sanoria literally means a pick-pocket. They are now agriculturists, cattle breeders and are reported to be taking to education in Hindi and consider themselves to be advanced. The different castes which formed the confederacy for thieving do not inter-marry. An Ahir Sanoria will not share the '*h iqqa pivi*' with a Brahman Sanoria for the Ahir thinks a greater stigma attaches to the latter who is the real descendant of those who first took to thieving. The Sanorias never use violence in their craft in which they show considerable smartness so much so that one Ruler looked upon their proceedings as petty thefts and did not interfere with them. While another, the Rani of Tikamgarh, was apparently much surprised that the British Government objected to her subjects "proceeding to distant districts to follow their occupation stealing, by day, for a livelihood for themselves and families both cash and any other property that they could lay hands on."¹ The Sanorias could not have better apologists.

16. **Dangi.**—A cultivating caste numbering 45,064 found in the Bhopal Agency States and in Indore. It is also found in Orchha and Datia and has possibly spread to these places from Saugor district in the Central Provinces where the bulk of them have been enumerated. They appear to be a mixed Rajput caste and this explains the tradition of their origin from a certain Raja Dang about whom nothing is known. Raja Dang once met in a forest an *Apsara* (Indra's dancing girl) who being cursed by God Indra, was wandering in the shape of a mare in the day time while in the night she assumed her original form. Raja Dang made love with this *Apsara* which resulted in her giving birth to two sons who became the originators of the community now known as Dangi. A rude couplet says :—

Kahawat.

Jitki ghorî tit gayi

Dang hath karyari rahi.

17. **Gadaria.**—Gadarias are an occupational shepherd caste distributed all over Central India but mainly concentrated in the Bundelkhand States and in Rewa and Indore. In all probability they have spread from northern India to these parts.

18. **Gond.**—The Gonds in Central India form about 3 per cent. of the total population and during the decade have increased by 14 per cent. The bulk of the Gonds have been enumerated in Rewa. They are found in small numbers in the other Baghelkhand States and in Panna and Ajaigarh as well. In western Central India they are chiefly returned from Bhopal and Indore. They are localised in these 2 States in the region between the Vindhya and the Narbada. The Gonds of southern Rewa are comparatively less civilized than those who have settled down in the plains. A list furnished from Rewa shows that there are 184 sub-divisions amongst the Gonds of southern Rewa. Many names appear territorial and some are totemistic. To the north of the Kaimurs the Gonds are also divided according to the number of gods worshipped. There are four divisions, *viz.*, (1) Chardeo (worshippers of four deities), (2) Panchdeo (worshippers of five deities), (3) Chhedeo (worshippers of six deities) and (4) Satdeo (worshippers of seven deities). Marriage in the same sub-division is not permitted. In certain places the marriage is settled by the following process. A flat vessel full of water is placed in the centre in which are dropped seven grains of black corn from the girl's side and seven grains of white corn from the boy's side. When out of these fourteen grains, one white grain in conjunction with four or five black grains floats together the marital union becomes complete and irrevocable. At other places another custom is in vogue. A circular cut is made in the bark of a tree. From the girl's side, the father or the grandfather or the head of the girl's family shoots arrows at the area marked. Then arrows are shot at the same place from the boy's side. If the arrow from the boy's side knocks down the arrow belonging to the girl or lodges itself at the place where the girl's arrow has struck before, the union is established. The Brahman is consulted for the auspicious date and in order to remember the day given by him a thin rope is given as many knots as the number of intervening days pointed out by the Brahman. Every evening one knot is untied till the day of marriage is reached. The sister's husband or the father's sister's husband of the bridegroom officiates at the ceremony and makes the married couple take 7 circumambulations round the fire. On these occasions wine is indulged in excess and the '*Karma*' dance is held on 2 or 3 successive nights. The food of the Gond in south Rewa is varied. When he is not settled down to an agricultural life, he wanders in the

¹ Kitts *op. cit.* 86.

forests in search of game, equipped with bows and arrows and an axe. When game is scarce roots of various trees are eaten and the budding leaves of *Pipal* and tamarind and other trees are boiled, dried and preserved to serve as food in times of scarcity. Water is taken out of the boiled rice and kept separate. This is an important item of food. Living in the undeveloped forest regions the Gond still leads a simple and primitive life. A match box is rarely found with him. A flint called *chakmak* is usually used in producing fire and it is carried in one corner of his headwear. In the rainy season, when the soil is damp and dry leaves are not found on the ground, they also keep a little cotton along with the flint to produce fire. Their favourite musical instrument is a drum-shaped instrument called *Mandor*. Males indulge in singing, playing and dancing while females dance to the music. The principal dance is the *Karma* dance. Men and women form two long lines in opposite rows and advance and retreat alternatively. When both the parties come quite close to each other, they gradually retrace backwards. If in this revelry, any male or female inspire love to one another, then the lovers concerned catch hold of the fingers of the hands and feet of each other. If such demonstration of love is reciprocal, a conjugal union takes place. No objection is raised to such a course as the whole affair of music and dance is looked upon as divine. Those Gonds who have settled in the plains have taken to agriculture and in their habits and customs resemble the lower castes of the general population. They still retain their tribal individuality. The Bhopal Gonds have few totemistic sub-divisions. One section does not touch a horse or mare and another a goat and in matters of religion they are still animistic and their chief deity is *Baro deo*.

19. **Gujar.**—The Gujars number 84,813 and have increased by 12·5 per cent. They are chiefly found in the Malwa States and over half of them were enumerated in Indore State where they are in large numbers in the Rampura and Nimar districts. Except in Datia the Gujars have not spread east.

20. **Kachhi.**—Next to Ahir the Kachhi is the strongest agricultural caste whose traditional occupation is the growing of vegetables. The Kachhi is not found in central and southern Malwa. He is mainly to be seen in the Bundelkhand States and in Bhopal Agency. The strength of this caste is 224,212. They form 34 per mille of the population and have increased by 7·8 per cent.

21. **Khangar.**—A caste of village watchmen and labourers numbering 19,678, returned principally from the Bundelkhand States. Small numbers have also been returned from Indore and Bhopal Agency States. It is certain that Bundelkhand is the home of the Khangars. In Bundelkhand they have three endogamous groups amongst them: (i) Rai Khangar, (ii) Arakh and (iii) Pasi. The tradition of the origin of Rai or Raj Khangars is given differently in the 1901 report for this Agency and in Russel's *Castes and Tribes of the Central Provinces* in the article on Khangar. Some time ago a history of this caste was published by Govind Das of Chhatarpur. The writer tries to establish there that the Khangars were and are Kshatriyas, that they are descended from the Huns and the name Khangar is derived from *Khadgahar* meaning a Kshatriya who earns his livelihood by means of a *Khadga* (sword). Prior to the Bundela supremacy the Khangars reigned in Bundelkhand and Garhkundar was their capital. The rising clan of the Bundelas tried to exterminate the Khangars but a pregnant Khangar woman managed to escape and remained concealed in a *Kusum* field where a male child was born to her. She was rescued by a Dangi Thakur and since then the Dangi Thakurs have enjoyed great regard and respect in the eyes of the Khangars. The Khangars claim considerable pretension to be called Rajputs or Kshatriyas and the Kshatriya Khangar Sabha of Narsinghpur in the Central Provinces sent out the usual application to class the Khangars as Kshatriyas and from a Hindi pamphlet circulated from Narsinghpur it appears that they have succeeded in having a regular bardic genealogy. They even claim to have migrated from Cutch. Perhaps it is derogatory to be known as the indigene of Bundelkhand. Some of the Raj Khangars have divisions with the Rajput clan names but from a list furnished it appears they still have few totemistic divisions, though most of them have taken to Hindu *gotra*. In the United Provinces Census Report for 1911 it is stated that the Khangar is an example of Hinduised aboriginal tribe which has turned the original totem clans into Rajput *gotras*, supporting its claim to Rajput origin by a large body of legend and is now Hindu pure and simple in every respect. Whatever be their claim, it is clear that the Khangars are a pre-Aryan indigenous people of Bundelkhand and like the Bhars, a Hinduised section of them, the Raj Khangars held Bundelkhand in that period of tribal rule between the collapse of the Chandel power and the rise of the Bundelas. In Bhopal besides the Khangar proper, there are two other local sub-divisions Malvi and Mirdha. The Arakhs numbered 1,776 in this Census.

22. **Khati.**—An agricultural caste found mainly in Indore, Bhopal and Dewas States. This caste has not been returned from any State in the East.

23. **Kir and Kirar.**—Both are cultivating castes and for no very clear reason they were grouped with the animistic Bhil or Gond. The Kirars are bastard Rajputs and they have a Dhakar sub-division. Dhakar is another mixed Rajput caste. They observe Hindu customs in general. Familiarity between a married woman and her husband's younger brother can exist. The younger brother is allowed to have familiarity with the wife of the elder brother.

The husband has the privilege of familiarity with the younger sister of his wife. A widow is expected to marry the younger brother of the deceased husband. They worship *Mata Devi* and *Mahadeo Ling*. They cremate their dead. The nails and bones of the dead are taken out and buried under a small platform or tree as a temporary measure and subsequently exhumed and taken to the *Narbada*. Those who cannot afford to do this allow the remains to be buried.

24. **Kol**.—The Hinduised and Tribal sections of the Kols numbered 200,249 of whom 175,391 were returned from Rewa. The Kol group to which certain allied tribes should be affiliated numbers 303,810 and is thus as numerous as the Gond. There is evidence to believe that the Kols were the dominant race in the region between the eastern *Vindhyas* and the *Gangetic* plain before they were overwhelmed by the people of the plains to the north and by the incursions of the Gonds from the south. Their present day habitat points to the same fact for the Kol has not spread beyond *Baghelkhand* and its closely adjacent parts. The off-shoots¹ of the Kol tribe are also localised in a small area. Of them some have vanished though their memory is kept alive by tradition. The *Bhars*, *Seoris* and *Cherus* though they no longer maintain an identity of their own were probably derived from the same racial stock as the Kols. The *Mawasis* were reputed to be a fighting section of the Kols. But the present day Hinduised Kol is a perfect specimen of a subjugated aborigine. He has become the hewer of wood and drawer of water. He has lost his independence and is one of the most servile castes in the eastern parts. He has become a serf of the higher castes. Short of being sold as a slave in an open market, the status of a Kol is nothing but that of a slave. When the Kol borrows money for marriage or for any other purposes, in return for the sum borrowed he is required to assist in the work of cultivation for the whole of his life. He rarely gets an opportunity to redeem his debt. Others work as agricultural labourers and are given $7\frac{1}{2}$ *Khandis* (about 120 lbs.) of food grains every half year. As the family of the Kol worker increases his value as a slave also increases. A Kol cannot leave his master till the latter releases him but he may be transferred to another purchaser provided the former receives the required purchase money. The Kol speaks *Bagheli* having abandoned his tribal language long ago.

25. **Kotwar**.—A caste of village watchmen, like the *Balai* in *Malwa*, found principally in the *Baghelkhand* States. They are a low servile caste but rank above the impure castes.

26. **Kurmi**.—Next to *Kachhi* comes the *Kurmi*—a principal agricultural caste. The bulk of the *Kurmis* were enumerated in *Bundelkhand* and *Baghelkhand* States. In the western Central India they are found in numbers in *Indore*, and *Bhopal* States. Their recorded strength is 205,371. The *Kunbis* who are also an important agricultural caste are chiefly found in the *Narbada* valley. They have migrated from *Gujarat* side.

27. **Mahra**.—A caste numbering 8,682 returned exclusively from *Rewa* State, where it was enumerated in *Bandhogarh*, *Sohagpur* and *Beohari* *Tahsils*. It may be identical with *Mahars* returned in 1901 Census from the *Baghelkhand* Agency. From an account furnished by *Rewa*, it appears that the *Mahra* held important posts in the military force of the *Gonds*. When the *Gonds* lost power, the *Mahra* became degraded and took to agriculture and weaving. They appear to be akin to *Koris* or the *Panikas* of *Rewa*. Whether they are off-shoots of the *Gonds* it is not certain. The caste requires further investigation.

28. **Mina**.—Once a notorious tribe of predatory robbers, now settled in *Malwa* as agriculturists. In *Bhopal* Agency they are known as *Deswalis* possibly in preference to *Mina* which term had enjoyed an unsavoury reputation. The *Minas* are descended from the pre-Aryan tribes in *Rajputana*. The ancient *Tamil* poets designate certain savages of pre-Dravidian blood and one of them is *Minavar* (Fishers) and the *Minas* may be descended from them.

When *Rajputana* became the home of the *Rajput* clans in the medieval times, there was much inter-mixture of *Rajput* and aboriginal blood and the *Minas* are consequently of mixed origin. In Central India they have two sub-divisions—*Deswali* *Minas* and *Malvi* *Minas*. Among them two sisters are not allowed to marry one man at the same time. The younger brother can marry the widow of the elder brother but the elder brother cannot marry the widow of the younger brother. The younger brother is allowed to have familiarity with the wife of the elder brother. The husband has the privilege of having familiarity with the younger sister of his wife.

The *Minas* regard the Sun and the Moon as males, and they are considered to be the two eyes of *Parameshwara* and the stars are the souls of the dead people who are not to be given another chance for coming back to the world. The *Pleiades* is called '*Guchha*' as well as the cluster of 7 maids (*sat sahehi ka jhund*) and the milky way is said to be the road for *Raja Indra's* elephant. The cause of the earthquake is said to be due to the earth being supported on the hood of a snake whose move causes the tremor. As to lunar eclipse it is said that the moon, a *Brahman* by caste, had an occasion to borrow money from some sweepers of which some could not be repaid. The creditors who came to make a demand touched him, as a result of which the moon (probably in trying to purify himself) scratches his body. The rainbow is said to be a bridge.

¹ Vide Table in para. 208, Chap. XII, *supra*.

They erect platforms and buildings in memory of their well-to-do dead ones at the site of cremation. As to the ultimate abode of the dead it is believed some go to heaven and some to hell. After an enquiry a new soul is given to the deserving to enable them to take a re-birth.

29. **Nai.**—The Nai caste (94,884) is fairly well scattered all over the Agency. No Nai has returned himself as a Nai-Brahman though outside agencies agitated for showing this caste as Nai-Brahman.

30. **Nayata.**—A Muslim caste numbering 7,499 and enumerated in Indore and in the Malwa and Southern States Agencies. It appears to be formed of Hindu converts who embraced Islam during Muslim supremacy. The Nayatas like other castes have the usual tradition of their origin. Once upon a time under God's will boiling water began to flow out of the hearth of an old woman. The large stream formed began to sweep away everything, the prophet Neo the great floated a boat on it and saved only those persons who embraced Islam while the rest were drowned. Those who were converted were considered his relatives and were called Nayatas. The caste does not inter-marry with any other Muslim sect in spite of its adoption of Islam. Hoshangshah Ghorī, the ruler of Malwa, is said to have invited them to settle in Malwa. 362 families are said to have accepted his invitation and come from Gujarat to settle in Malwa. The head of each family was made a *patel* or a headman of village. In their marriages they consult the village Brahman, *Parsai*, to fix a day for marriage. Their marriage customs are like those of the Hindus. On the day fixed for marriage a procession starts for the bride's house where visitors are received. The bridegroom touches the ornamental hanging on the door with the sword he carries. A witness on behalf of the bridegroom and a representative on the part of the bride are appointed and the ceremony of *Nikah* begins. The consent of the girl is communicated to the *Kazi*. Verses from the holy *Koran* are recited and the ceremony of *Nikah* is finished. Next day the bridegroom's party goes to the bride's house. The newly wedded couple are seated on a bed and the hand of one is locked in that of the other with a betel leaf and a silver ring between. The bride's brother separates the hold and gives a cow or some cash as present. On the conclusion of marriage festivities presents in the form of money are sent to Mosques and Temples as well. Although the Nayatas are Sunni Muhammadans they worship Hindu deities, such as *Sitlamata* or the presiding deity of small-pox, *Bheruji*, etc., and some families observe the Hindu festivals of *Nagpanchami*, *Diwali* in addition to *Moharrum*, etc. The Nayatas worship cow as a sacred animal and abstain from beef. The females' dress consists of a skirt and veil like that of Hindu cultivating castes. Men wear *dhoti* like the Hindus.

31. **Rajput.**—The Rajputs number 388,942. Next to the Brahman and Chamar castes, they are the largest in number and form 59 per mille of the total population. Besides the well-known clans, a considerable number of mixed castes of Rajput origin get classified as Rajputs. The distribution of the clans follows the historical and migrational events in the history of Central India. The following table shows the clans and sub-clans and the septs of the more important Rajput groups in Central India :—

Clans and Sub-clans (<i>Kula</i> and <i>Salha</i>).	Septs (<i>Got</i> , <i>Khamp</i>).
1	2
1. Rathor (Surajwansh)	Jodha, Mertia, Bharmalot, Champavat, Kumavat, Jetavat, Sangara, Sanchara.
2. Chauhan (Agnikula)	} (2 a, b, c do not inter-marry).
a. Deora	
b. Hara	
c. Khichi	} (4 a, b do not inter-marry).
3. Gahlot	
a. Sisodia (Surajwansh)	
4. Jadon (Yadav) (Chandrawansh)	} (4 a, b do not inter-marry).
a. Bhati	
b. Jareja	
c. Tuar	} (The 4 Agnikulas Chauhan, Paramar, Parihar and Solanki can inter-marry).
5. Paramar (Agnikula)	
Panwar (Maratha)	
Panwar (Bundelkhandi)	} (7 a and b cannot inter-marry).
6. Parihar (Agnikula)	
a. Baghela	
b. Virupa	} (7 a and b cannot inter-marry).
7. Solanki (Agnikula)	
a. Baghela	
b. Virupa	} (7 a and b cannot inter-marry).
8. Gaur	
9. Gohel (Chandrawansh)	
10. Kachhwaha	Rajawat, Shekewat.
a. Naruka (Surajwansh)	} (The Bundela Rajputs up till recently formed a local endogamous group. But in recent years marriages have taken place between them and the Gohel, Jhala and other Rajputs.
11. Jhala (Makwana) (Surajwansh)	
12. Bargujar	
13. Bundela	

The Rajputs of Malwa belong to the several well-known clans, famous in the medieval history of India. They are too well known to need a recapitulation here. The Bundela Rajputs are a local group confined to the tract known as Bundelkhand and they form a local endogamous group, which inter-marries only within the group, having (up till recently) no connection with the well-known Rajput clans of Rajputana and elsewhere. The three Bundela clans are Bundela, Dhandera and Ponwar Rajputs of Bundelkhand. The history of the Bundela occupation of the tract which now bears their name is given in the Orchha State Gazetteer. Vincent Smith thinks that the Bundelas are an off-shoot of the Gaharwars who in all probability were an aristocratic section of the Bhar tribe. Kennedy terms the Bundelas, a degenerate branch of the Gaharwars who established their principality in Orchha and gave their name to Bundelkhand.¹ The name Bundela is said to be derived from 'bund' a drop (of blood) or more probably from Vindhya, corrupted to Bundela, for tradition has it that the ancestor of the Bundelas, Pancham Bundela or to give him his proper designation, Hem Karan (circa 11th century A.D.) who on his expulsion from the State after his father's death, went to the shrine of Devi Vindhya-Vasini, near Mirzapur, where his devotion enlisted the support of the goddess. This is said to be the origin of the name of the clan Bundela being a corruption of Vindhya. The Dhanderas are an off-shoot of the Chauhans who give their name to Dhandelkhand, the tract in which the State of Khaniadhana (now in Gwalior Residency) lies. They have an unconvincing tradition of their migration from Cutch and its capital Bhuj. They form an exogamous local group inter-marrying with the Bundelas and the Bundelkhand Ponwars. The last claim descent from the Paramaras of Malwa but there appears to be no connection with the present day Paramars or the Panwars of Malwa, the latter of whom are Marathas. As already stated these three clans form a single endogamous group. Hypergamy is unknown. Each member of one of these clans is obliged to marry into one of the other two. A man may marry a girl from the clan to which his mother or either of his grandmothers belonged.

32. **Satia**.—Only 64 males and 70 females have been returned under this name. The Satias are a wandering tribe. They keep moving from one *hat* (weekly market or fair) to another with their animals, oxen and bullocks. They buy young oxen cheap, castrate them and sell the bullocks at a higher price. It is considered unlucky, if not a sin, to have one's oxen castrated, for after the castration should a calamity befall a family the superstitious people attribute it to this practice. The cultivators part with their oxen cheaply because of the difficulty and danger in controlling them and exchange them for, or buy bullocks from the Satias, who though Hindus have no scruples or compunction about this sort of practice or traffic and who do generally castration themselves. They have no settled homes and move about with their families in bullock carts. The Satias were perhaps once Rajputs, forced by circumstances to a wandering life. They appear to come from Harauti district (Jhalrapatan) in Rajputana. Their dialect contains few mutilated words of Harauti dialect. In Central India they speak Malvi generally. They are superstitious and hold the *Pipal* tree as sacred and take their oath in the name of this tree. They believe in spirits and minor gods of the Hindus. Among them exists a peculiar practice of mortgaging their wives, daughters or other female members of their family to money-lenders of their own caste for the debts contracted by them. To the creditor or to a person who stands surety for a Satia for a debt or for the performance of some engagement usually in a caste dispute, the Satia makes over his wife or any other female relatives till she is redeemed on payment of the debt or on fulfilment of the obligation. The usufructuary right in this human chattel is recognised and if the woman conceives during the period of transfer the child is claimed by and left at the house of the temporary or substitute husband. No shame or immorality is attached to the woman or her husband who pledges her. This does not mean that Satia women are of no account. They generally assist in managing animals and in driving bargains, etc.

33. **Sirvi**.—A cultivating caste exclusively found in the Narbada valley. It has migrated from Rajputana. The Sirvis make excellent cultivators and are famous for the skill they possess in marking out places where wells could advantageously be dug. That they are of mixed Rajput descent is clear from the tradition of their origin. They trace their descent from 24 Rajputs who survived after their Chief's death when the fortress of Kalupur was taken. They were so ashamed of their survival that they threw away their swords, dropped their Rajput name and took to cultivation under the name of Sirvi which is, according to Malcolm, the derivative of the Malvi word *Sir* 'Cultivation.' This tradition is perhaps a convenient way to explain that they were originally degraded or bastard Rajputs who as a mixed caste were compelled to cultivate and not wield the sword. Their social position is nevertheless high for when Malhar Rao Holkar was married to a Sirvi woman the Maratha Ruler was represented by his sword to which the female was united. The Rulers of Indore are of Dhangar or shepherd caste. The Sirvi woman married the wearer of the sword and not the shepherd.

34. **Sondhia**.—A mixed Rajput caste. It has given its name to a tract in Malwa called Sondhwara which stretches from Mahidpur as centre to Ujjain in south, to Shajapur in east, to Rampura in north and to Rajputana in west. The Sondhias who invariably term

¹ *Indian Empire*, Vol. II, 318.

themselves Rajputs and like to be styled Thakurs, are the inhabitants of this tract. They have long been notorious as thieves and cattle lifters. Malcolm wrote about them thus: 'The Sondies have been either cultivators or plunderers according to the strength or weakness of the Government over them; but they have always had a tendency to predatory war and have cherished its habits, even when obliged to subsist by agriculture. They are in general, robust and active, but rude and ignorant to a degree. No race can be more despised and dreaded than the Sondies are by the other inhabitants of the country.'¹ Malcolm noticed their women were equally turbulent and bold and immoral. Many of them were skilled in the management of the horse. They have now taken to the more peaceful occupation of agriculture but are occasionally inclined to be turbulent and in years of scarcity and famine take to their old pursuit of cattle lifting. Traditionally they derive descent from Rajputs. The story runs: they fought on the side of the Emperor against Aurangzeb at Fatehabad near Ujjain in 1627. They were then Rajputs, forming part of the army led by Jaswant Singh of Jodhpur. Disgraced by this defeat they dared not return home and took up their abode in the tract now known as Sondhwara. Here they inter-married with the local people and thus produced the Sondhia Rajput group. They state that Semri in Udaipur State and Dhabla and Dokhada in the Narayangarh district of Indore State are their centres and the headmen. "Thakurs" as they style them, of these places are looked up to as leaders. In 1901 Census this caste was taken as an instance of a caste being degraded into a tribe (India Report, 1901, page 533). It is doubtful if the Sondhias could be described as a tribe. They are a mixed caste arising out of the union of the Rajputs and the local aboriginal women. This is not however admitted by the Sondhias themselves. The Sondhias form a single endogamous group and ten out of the 24 septs are looked upon as being of purer descent, their Rajput origin being admitted, while the other septs seem to derive their Rajput blood from the first ten by inter-marriages.

¹ *Memoir*, ii, 153-154.

APPENDICES.

- APPENDIX I.—An ethnographic account of the Bhils of Central India.
- „ II.—Migration of Castes and Tribes into Central India and their distribution.
- „ III.—The depressed classes.
-

APPENDIX I.

An ethnographic account of the Bhils of Central India.

SECTION A.

THE BHIL TRIBE.

[NOTE.—The only detailed account of the Central Indian Bhils is that contained in a monograph entitled *the Jungle Tribes of Malwa* which formed the second volume of a series of an uncompleted ethnographical survey of the Central India Agency by the late Colonel C. E. Luard, C.I.E., who for three successive decades from 1901 was in charge of the Agency Census. The materials for this monograph were collected by him in connection with the 1901 Census and published a few years later. So far as I know only two copies of this monograph are extant. As there was a danger of the valuable information contained therein being lost, I have reproduced them in the following pages, rearranging the matter and considerably abridging certain unnecessary details, supplemented here and there by fresh materials collected in the course of the present Census. The specimen of Bhil songs has however been reprinted *in extenso* without any change. I am also indebted to Mr. R. M. Puranik, M.A., LL.B., Census Officer of Dhar State and to the Roman Catholic Mission at Jhabua for placing useful notes at my disposal. It should be pointed out that no attempt has been made in the notes to distinguish the matter extracted from Colonel Luard's monograph from the supplementary notes.]

1. **Strength and distribution.**—According to the Census returns there are 363,124 Bhils in Central India. Of these 144,836 returned themselves as Hindus and the remaining 218,288 retained their allegiance to their tribal religion. The true strength of the Central Indian Bhils has hitherto not been estimated. Certain tribes allied to the Bhils are paraded under different labels in the Caste table as separate castes or tribes. The strength of the Bhil group of tribes is considerable if we amalgamate, as we should, the figures for a number of the allied tribes. As far as it could be ascertained the following statement gives the composition and strength of the Bhil group:—

Bhil group.	HINDU.			TRIBAL.		
	Persons.	Males.	Females.	Persons.	Males.	Females.
1	2	3	4	5	6	7
1. Bhil	144,836	73,939	70,897	218,288	109,666	108,622
2. Bhilala	187,145	94,926	92,219	6,630	3,363	3,267
3. Barela	38,517	19,647	18,870	108	59	49
4. Mankar	20,430	10,058	10,372	49	26	23
5. Nihal	11,529	5,766	5,763	702	350	352
6. Patlia	8,268	4,280	3,988	11,140	5,812	5,328
7. Rathia	37,260	19,028	18,232

The Hinduised section forms 6.8 per cent. of the total population and the Tribal section 3.6 per cent. Thus the Bhil group constitutes one-tenth of the total population of Central India. The tribes enumerated above are exclusively found in western Central India. Only few stray Bhils have been enumerated in the eastern parts of the Agency. In the West their real home is the Vindhya and the Satpuras. The bulk of them have been returned from the States of Ratlam, Sailana, Jhabua, Dhar, Ali-Rajpur, Barwani and Indore.

2. **Name.**—It is commonly held that the word Bhil is derived from a Dravidian word for a bow (Tamil and Kanarese *bil*) which is the characteristic weapon of the tribe. The ancient Tamil poets termed certain savages of the pre-Dravidian blood as *Villavar* (bowmen) who 'may possibly be identical with the modern Bhils.'¹ If that be so, the name may have been given to the Bhils by the Dravidians. In common with the various Munda tribes, such as the Kols, Santals, etc., the tribal name, is not used by the members of the Bhil tribe among themselves. They employ the usual titles of relationship or position such as *Bap* (father), *Tarvi* (headman), *Nahal* or *Naik* (an honorific term). When addressing entire strangers the polite prefix *da* is added, as *Da Rupa*, *Da Walji*, etc. When the Bhils came in contact with the Aryans, they again figure in the Sanskrit literature. Thus the word *Nisada* which occurs in the early Vedic literature is sometimes held to mean a Bhilla or Bhil, though others hold that 'the word seems to denote not so much a particular tribe but to the general term for the non-Aryan tribes who were not under Aryan control.'² In the later system, the *Nisada* is the off-spring of a Brahman

¹ *Cambridge History of India*, Volume I, page 595.

² *Vedic Index*, Volume II, Nisada.

and of a Sudra woman.¹ According to Mr. Enthoven the earliest mention of the word Bhil occurs in *Katha-Sarit Sagara* or *Gunadhya*² wherein mention is also made of a Bhil chief opposing the progress of another king through the Vindhya. These references show that the Bhils are one of the earliest races in India and they have been brought into contact with all the great racial migrations into India.

3. **Origin.**—In the present state of our anthropological knowledge we cannot say whether the Bhils are autochthonous or not. At best we can only surmise and hazard some views leaving it to further scientific research to prove or disprove them. There is no doubt they represent a race which inhabited India earlier than the Aryans and the Dravidians. Very possibly they are a proto-Mediterranean race who spread far and wide when a climatic crisis occurred in the grass steppes of Sahara and it is this race which is responsible for the industry associated with the Final Capsian culture in the Vindhya. The Bhils are one section of the great Munda race which occupied the pre-Dravidian India and had for its home the central regions across the peninsular India with possible extensions into the Gangetic plain. The home of the Bhils has been the western Vindhya and it is perhaps in contact with the Dravidians on the other side in Gujarat they acquired their present appellation. If we accept the view which is gaining ground in recent years, that the Dravidians, a branch of the Mediterranean race, entered India through north-west then it is reasonable to suppose that Gujarat was on the way of the immigrant Dravidians in their march towards the Deccan and the south. Gujarat was a Dravidian tract before it was Aryanised. It is again significant to note that the home of the Nisadas as shown in the map in the *Vedic Index* exactly fits in with the historically known habitat of the Bhil tribe. There the Nisadas are shown as dwelling south-east of the Aravalli hills between the Banas and the Mahi rivers and up to the Chambal. The position shown is no doubt approximate but its significance cannot be underrated. The Bhils lay on the path of the conquering and the migrating Aryans towards Gujarat and Malwa. The impact of the Aryans must have caused the displacement of the Bhils along the Vindhya and into the Satpuras but any such movement was restricted because they were flanked by the presence of other tribes of the Vindhya and the Satpuras. In these hills the Bhils have maintained considerable independence glimpses of which we get when we read of a Bhil Chief in the Sanskrit book already quoted and also of the forest king who assisted the Emperor Harsha in the search of his sister in the Vindhyan forests of Malwa. The Bhils, however, never appeared to have become effectively masters of the plain because Malwa was colonised in very early times and in spite of political convulsions, civilization never fell as to facilitate the extension of tribal rule. Malcolm records that according to the Bhil tradition, their home is in the country to the north-west of Malwa from where they were ousted when the Rajputs began to conquer their country. This again meant a further displacement of the Bhils along the Vindhya. The tradition of the Bhils in Malwa points to immigration from a western home but the story of their change of habitat does not appear to have clearly survived. The Jhabua Bhils still retain some dim and incoherent outlines of their migration. Their story is that the first Bhils were the *Damor*. Another section of the Bhils were the *Warkrya* who were living with the *Damor*. One *Warkrya* committed violence on the daughter of a *Damor* as a result of which war sprung between the two people. The *Damors* fared badly in the struggle and they had to migrate. They stopped at a place called Dholka in Kushalgarh State (Rajputana Agency). This is supposed by the Bhils to be their original home and other tribes are said to have sprung from the *Damors*. The Bhils have their own traditions of their origin. One relates that a *dhobi* who used to wash his clothes in a river was one day warned by a fish of the approach of a great deluge. The fish informed him that as he had always fed those of his species he had come to give him this warning and to urge him to prepare a large box which would enable him to escape. The *dhobi* prepared the box and got into it with his sister and a cock. After the deluge Rama sent out his messenger to inquire into the state of affairs. The messenger heard the crowing of the cock and so discovered the box. Rama then had the box brought before him and asked the man who he was and how he had escaped. The *dhobi* told his tale. Rama then made him face in turn north, east and west, and swear that the woman with him was his sister. The *dhobi* remained firm in asserting she was his sister. Rama then turned him towards the south, upon which the *dhobi* contradicted his statement and said she was his wife. Rama then asked who told him how to escape and on hearing at once had the fish's tongue cut out, and since then that kind of fish has been tongueless. Rama then told the *dhobi* to set about repopulating the world, and he therefore married his sister by whom he had seven sons and seven daughters. Rama presented the first born son with a horse but the recipient of this gift, being unable to ride, left the horse on the plain and went into the forest to cut wood, he and his descendants becoming foresters and starting the Bhil tribe.

Another tale relates how on the creation of the Bhil, five men went to see *Mahadev*. *Parvati* seeing them approaching, said to her spouse, "Here come five of my brothers to ask *dahej* (bride-price) of you consequent on my marriage with you." *Mahadev* gave them a feast and then explained that except for his bull *Nandi* and his *Kamandaku* he had nothing to give. They therefore went home. In order to give them something, however, *Mahadev* placed a silver stool

¹ *Vedic Index*, Volume II, Nisada, foot-note.

² *Tribes and Castes of Bombay*, Volume I, Article Bhil.

in their way, but they were incapable of seeing this. *Parvati* noticing how they had missed the gift, sent for them and told them what had happened, pointing out that as they were not able to see the stool, there was little hope of their prospering, but she would do what she could, and so informed them that they must be very careful of the *Nandi* whose hump was full of wealth untold. On reaching home one of the five suggested slaying the *Nandi* and obtaining the wealth, the others demurred, but he prevailed. No wealth was found in the hump and the five were dismayed. *Parvati* now appeared and told them that they should have yoked the bull to the plough and thus gained wealth from mother-earth, but that as they were so foolish as to slay the sacred animal she would never look on their faces again, and left in high displeasure. For thus killing the sacred animal the Bhil has ever lived a miserable existence and been of no caste.

The Puranic origin of the Bhils traces descent from the thigh of *Vena*, son of *Anga*, a descendant of *Manu Sacyambhuva*. *Vena* was childless and the Sages therefore rubbed his thigh and produced "a man like a charred log, with flat face, and extremely short." He was told to sit down (*Nishada*). He did so and was known as *Nishada*, "from whom sprang the *Nishadas* dwelling on the Vindhyan mountains, distinguished by their wicked deeds."¹

The Rajputs have had a very long connection with the Bhils. Forced by circumstances to make an alliance with the denizens of the Vindhyan hills, the Rajputs did not hesitate to take women from the tribal ranks and this was responsible for the disintegration of the Bhil tribes into various Hinduised sections, such as Bhilalas, Patlias, etc. The infusion of Rajput blood has led in some instances to a distinction among the Bhils. For in some places the Bhils are split up into *Ujale* or pure and *Mele* or impure with a third or lower status the *Madalye* who are musicians and singers by profession. The *Ujale* and *Mele* Bhils are separate endogamous groups with septs which are exogamous.

4. Caste and Tribal sub-divisions.—The Bhils consequently are a very mixed lot at the present day. Besides the Bhil proper, the other tribes are Bhilala, Barela, Mankar, Nihal, Patlia and Rathia. The description given in the following paragraphs, relates to the Bhils as a whole. The other tribes are described briefly at the end of these notes. The divisions or the septs are very variously given and no two lists agree. They are summarised in a tabular form in a separate section. The usual reverence appears to be paid to any object which is regarded as a sept totem, it being never destroyed or injured. Nor is its effigy ever tattooed on the body.

5. Marriage: General.—The Bhil tribe being an endogamous group no Bhil can marry without it. The septs again are all exogamous and no member of a sept can marry another from the same sept. This prohibition is extended for 3 generations to any sept into which a man has already married. A man cannot also marry into the sept from which his mother came for 3 generations as the members of this sept are held to be the brothers and sisters of such man. The same rule is extended to the septs of grandmothers, maternal and paternal. A man can marry two sisters but the exchange of daughters between fathers is not usual. Certain occupations are now looked upon with askance, due to Hindu influence and certain families are inclined to reject marriage with a family which has taken up the following professions:—manufacturing of winnowing fans, and sieves, of a butcher, of a tanner, of a professional mendicant, of a *Rawal*, or dancer and singer. Sometimes though it is not a formal restriction, the village Bhil does not like to take a wife from among the Bhils living near the *bazar* or in the town. The rural Bhil has a low opinion of the town dweller and he does not think much of the morals of the *bazar* Bhil girl.

Marriage is adult and infant marriage is non-existent unless Hindu ideas have overpowered the tribal practice. The earliest age for marriage of girls is 12 years, while most are married between 15-40. Puberty has no place in determining the age at which the girl is to be married. In accordance with the Hindu ideas, the parents settle the marriage, and courtship, though apparently by no means uncommon, is not in general vogue.

Where pre-nuptial sexual intercourse takes place with the affianced husband, no penalty is incurred, except that the regular marriage ceremony is omitted, the girl being simply made over to the man. If the sexual license is indulged by the girl with another than her fiance, she is, if the fiance still desires it, made over to him but the support of the child born of the irregular intercourse is borne by the real father.

6. Marriage ceremonies.—Four persons from the boy's side go to the girl's house to settle the betrothal. If the girl's guardians are willing a sum of Rs. 7 is paid to the *panches* who purchase *gud* and wine and entertain the caste people. The betrothal then becomes irrevocable. When means permit some persons from the boy's side go to the bride in the company of some guests and entertain the members of the caste with wine and *gud* worth Rs. 9. The party is then entertained by the girl's father and thus end the rites of *Badi Sagai*.

When marriage preparations begin a party consisting of 5 to 25 guests starts for the bride's house. After mutual entertainments the boy's father pays Rs. 41 for the dowry and the celebration of marriage is settled. The party then returns home.

¹ See *Mahabharata*, *Vishnu Puran*, *Hari-Vansa*, etc

The boy and girl in their respective houses are anointed with oil and turmeric. This marks the commencement of marriage ceremony which is known as "*Bana Baithana*." This ceremony is performed at the bride's house on the day next to that on which it is performed at the boy's. They are daily taken in procession at their own residences when their relatives give money varying from an anna to a rupee. As soon as these *Banas* have finished the marriage-shed is erected. Four poles are located in the ground and the shed is covered with *jamun* leaves. It is decorated on its sides by the hangings of mango leaves. One post is fixed in the *mandap* which crosses the roof and goes high above the house with leaves of *jamun* tied to its top. Four unmarried boys and girls first dine under the *mandap* and then the whole caste is entertained with "*Makka Thuli*." The relatives then give clothes to the members of the family which is called "*Perawain*." The bridegroom is attired in marital costume of red and white. Round his waist a scarf is tied. He takes dagger and sword in his hand. Well clad and ornamented, he puts on his head the marriage crown of imitation pearls and stands under the *mandap* where his mother moves rice-pounding pestle, arrow, and grain thrasher, etc., round his face and throws 4 cakes in four quarters, this ceremony being called *Padachhana* ceremony. Placing a coconut at the feet of *Mata*, the wedding party starts at night for the bride's village and stops at that place where fire is kindled for them by the bride's people before the dawn.

The bridegroom then touches the ornamental hanging on the door with the sword he carries and is seated under the booth. A pair of cloth and shoes, and a bodice are presented to the girl early in the morning. The bride is bathed and dressed in those clothes. The same "*Padachhana*" ceremony is repeated here by his mother-in-law. A long piece of cloth is put round his neck and his mother-in-law draws him on to the picture of their family deity, by holding the ends of that cloth.

No sooner the bridegroom reaches that place then the bride extinguishes the lamp burning there. The boy again lights it and worships the *Mata*. The ends of the upper garments of the couple are knotted and the bride's brother joins their hands. Subsequently he separates the hold and is given some *gul* for his service. A caste dinner is given after which the whole party goes to a stream or river to clean their hands and mouth, the females dining at home. The auspicious "*Kankan*," and copper ring are tied round the wrist of the bridegroom there. After the party returns from the stream the cloth of the couple is knotted and the couple seated on a piece of cloth. The hand of the one is locked in that of the other and this is called "*lagan*." A Brahman or any caste member in his absence, assists in the performance of "*hom*," in which oblations of *ghee*, oilseeds, etc., are offered. With their hands joined the couple give 7 turns round the nuptial fire. Then follows *Kanyudan*. Some clothes, silver ornaments and cash varying from one to five rupees are given. The hold of the hands is separated.

A few days after that the members of the bride's family come to the boy's house to fetch the bride. When they come they ask the boy's parents whether they are asleep or awake. When the boy's father hears this he brings a cock or a goat, which is killed by the bride's party. The guests are then entertained and the bride taken to her parent's house. The same custom is observed when the boy's party goes to fetch the bride. These rites are called "*Ana*" rites. Generally one rupee is paid to the Government as a marriage fee.

7. **Other forms of union.**—The description given above applies to the orthodox form followed by well-to-do and the completely Hinduised section of the Bhils. The Bhil knows to his cost that the adoption of Hindu customs is extremely expensive. The whole series of the marriage customs amount to a total of at least Rs. 350 which is a minimum. Many boys cannot afford such a sum of money. So sometimes after formal betrothal they take away their betrothed by surprise, by force or by mutual secret consent. They thus save a great deal of money and incur few expenses. Sometimes the girl of her own accord goes to the house of a young man and declares her intention to remain there. The union is regularised by the recognition accorded by the *Panchayat*. When a man has not enough money to perform a solemn marriage he searches for a girl whose price is cheaper. A girl who has had a child or a rejected girl, would be his likely bride. She is given a '*Lugra*' and '*Ghagra*' and some money. The girl becomes his wife without any further ceremony.

8. **Ghar Jamai.**—The payment of bride price by means of personal service is often met with. Where the girl's father is well-to-do the young man undertakes to serve a term for his future father-in-law. This is commonest where the girl has no brothers to assist the father in his work. The usual term of years is seven. It is reported that in recent times it has become the practice of making him serve for 9 years. Though not seldom, the *Ghar-jamai* often escapes with his wife after 2-3 years. Ordinarily the two live as husband and wife but cannot leave the bride's home until the period of service is complete. If the two live amicably but after 2 years have no issue, the father-in-law has them anointed as if for a regular wedding and they are made to do 7 '*Pheras*' as in ordinary marriages. The father-in-law provides the young couple with means to start their own home.

9. **Marriage by capture.**—Marriage by capture or *ghiskarlejana*, is still common. The usual time for abducting a girl is on the *Bhagoria* festival, the day before the *Holi* is burned. The young man assisted by his friends enters the village and makes off with the girl. Occasionally the union is regularised by going through a short ceremony which is also performed in the case of a girl who falls in love and goes off with the man of her choice.

10. **Re-marriage of widows.**—The re-marriage of widows is permitted. There is, however, no obligation for her to marry any particular person such as her husband's younger brother (*dewar*). When the consent of the lady is known the suitor goes to her village with some clothes as presents and attended by four or five friends. He pays seven pice to the widow's brother's wife (*bhabi*) or to her paternal aunt (*phuuva*), provided they have husbands living. A general drink is then indulged in, in which the *Tarvi* of the widow's village takes part, and the ceremony is complete. This re-marriage is always done by night. The widow never enters her new home by day, as this will, it is believed, produce famine. Any person who accompanies the man marrying a widow is bound to carry out this duty seven times.

The widow, and children by the re-marriage, have no interest in the property of the first husband after re-marriage.

In a case where she marries her deceased husband's younger brother, should there be already a son by the first husband, children by the second have no rights in the property of the first husband. If, on the other hand, there was no child by the first husband, children of the second inherit the property of the first husband.

11. **Divorce.**—Among the Bhils divorce is frequent. The man who keeps a woman who has left her husband has to pay her former husband whatever expenses the latter has incurred in marrying her. Any reason is sufficient for a divorce. To effect a divorce the injured man calls together his village *panchayat* and in their presence tears off a piece from the end of his turban which he hands to his wife, stating that finding that her conduct was bad he is divorcing her and that from this day forth she will stand to him in the relationship of a sister. The divorcee takes the piece of cloth and hangs it carefully on a rafter of her father's house, for a whole month.¹ This shows that her former husband has no further rights over her and she can re-marry.

The Bhils are very suspicious of their women folk, and not without reason as the majority of the criminal cases which are brought by Bhils concern their women. This is a reason why they do not build their houses close together.

12. **Funeral ceremonies.**—The Bhils cremate their dead. They bury young babies whose teeth have not yet appeared, lepers and persons dying of small pox and of suicide. All these are buried in sleeping position. An ascetic is buried in the sitting position. On the occurrence of death notice is given by firing off guns before the deceased's house, while the village *dhobi* sounds his drum. The corpse is bathed in cold water and dressed and in the case of unmarried adults some turmeric is thrown on the dress. It is placed on a bier with the face upwards and covered with a cloth. Two coconuts are hung at the head of the bier. The eldest son or a near relative, if there is no son, takes an ignited cake of cowdung in his hand and the corpse is carried to the cremation ground, the man with the fire leading the way. Sometimes music played softly, accompanies the bier. The corpse is always carried so as to lie north and south, the feet pointing to the south. In the meanwhile, in the deceased's house a small lamp is placed upon the spot where the person died, sprinkled with maize and covered with a bamboo basket.

On coming to a *ber* tree (*Zizyphus jujuba*) the corpse is set down, while all the persons present proceed to take up stones with which a heap is made. A piece of cloth is then torn off the dead man's garment and thrown over the tree. The corpse is then picked up, those formerly at the head going to the feet. Tradition has it that the rest under the *ber* is made for this reason. Once the son of an aged dame died. The old woman carried his corpse as far as a *ber* tree but could not go on further. She then decided to appeal to the gods by fasting, for the restoration of her son's life, and sat for three days fasting beneath the tree. This was not the fruit season, but seeing her piety the gods gave the tree fruit, and also caused hunger to attack her. She could bear her pain no longer and rose to seize the fruit. Suddenly the tree grew and raised the fruit beyond her reach. At length she propped the corpse against the tree and standing upon it reached the fruit. She had broken her vow and the village people took and cremated the corpse. To avert any such evil each corpse is now halted under a *ber* tree, and a piece of the garment is offered to the gods. The earthen vessel consisting water to wash the corpse is taken and broken under this tree on the heap of stones.

Burning *ghats* are situated anywhere near a stream or tank. The body is placed on the pyre with its head to the north and burnt together with man's bow, club, etc., and in the case of a woman some favourite ornament. The unconsumed bones are carefully collected from the pyre and separated from the ashes. The bones are placed in an earthen vessel and buried near the house. There they remain till the 12th day ceremony is performed. If there is no chance of carrying out the ceremony they are thrown into the nearest river, usually the *Narbada*. The deceased is provided with food and drink on the 3rd day, the provisions being placed under the *ber* tree where the corpse rested. The stones heaped up there are scattered.

13. **Belief in a future life.**—The Bhils have some definite ideas about the future of the departed soul. The flour round the lamp is examined and by the shape of the marks, it is determined what animal the spirit of the dead will next inhabit. If it is like a human foot-

¹ Sometimes for half a month only.

print a man is his next abode ; if like a hoof, a horned animal ; if like a bird's foot, a bird ; if like a scorpion or snake, one of these animals. It is also believed that *Yama* comes from the south and carries the soul of the dead man to the north. On the way the soul passes over a thorn-strewn plain. Hence shoes are given as gift on the day of the funeral feast or else his spirit suffers greatly. He then passes between two heated pillars ; the spirit then encounters a *bhatyari* (keeper of cook shop) who offers him hot cooked food. He then reaches a river. A cow is given as a gift. It is supposed this animal providentially appears and by treading on its tail, the departed gets across, otherwise he suffers agonies and is half drowned. On reaching the end of the journey *Yama* determines which of the three hells (lit. *kunds* or tanks) he is to enter, one being full of nectar, the others of varying degrees of foulness (worms, blood, etc.,) until he is born again. Those who die a violent death become inimical spirits (*bhut*), so do *Badwas* or medicine men ; others become *Khatris*, who however cannot harm human beings but only animals, and others *Deos* who are beneficent spirits. A sinner is also believed to be transformed into an insect.

14. **Memorial stones to the dead.**—When a man is killed in a fight or by a wild animal away from his home, a stone monument is erected at the spot where he died. A man on horse back is generally carved on the stone. Such monuments are common in the Bhil tracts to the north of the Vindhya. Among the Satpura Bhils—the Tadvis mainly—memorial stones to a person of importance are quite common. The commemorative monument is usually of stone but wooden ones are also found. If stone is unavailable for any reason wooden monuments are erected. These Satpura monuments are somewhat elaborate. First of all there is an upright stone monument of about 3½ feet high on which the figure of the person in whose memory it is erected is carved *i.e.*, a man or a woman. In front of it are two wooden posts, 4½ feet high with a bar placed across them on the top. Suspended from this bar is a small wooden swing. This is followed by two small wooden posts, not more than 2 feet in height and finally there is a small stone slab of about 1 foot high and 9 inches in breadth. The most distinctive feature of these monuments is the wooden swing. This is meant for the soul of the departed. It comes and perches on the swing and enjoys itself. On the smaller wooden posts, a cross bar is placed on which food and offerings are left for the spirit of the departed. In times of distress and trouble the spirit is invoked and it is believed that a childless woman will be blessed with progeny by offering prayers at the monument.

15. **Religion.**—It is difficult to describe precisely the religion of the Bhil. He has been in contact with Hinduism for a long time and in spite of his preference to Hindu gods and godlings, his outlook is essentially animistic. The Bhils call themselves Hindus, invariably asserting that they are the followers of *Mahadev* and they have appropriated all the well-known gods of the Hindu pantheon. *Baba deo* is a generic term for the village tutelary deity. In *Shrawan* he is specially worshipped. All the village collects at the forest where he is making his abode and offer liquor, grain and fowl. Many other forest, woodland and mountain deities are worshipped. Local gods vary with almost each village.

Brahmans are not as a rule employed for religious or ceremonial purposes. The *Badwa* or the medicine man is an important person in their tribal life. He evokes spirits and tells them the results. On such occasions the *Badwa* or witch is supposed to be possessed and goes through a performance consisting of various contortions of the body and rapid movements of the head, the eyes roll in their sockets while the nostrils are distended and in the excitement the few rags worn are often thrown off. The possessed being then half inconveniently blabbers out what the spirit has told him, and soon after calms down and for a time becomes as helpless as a child, doubtless owing to the exertion he has undergone.

In casting out disease or an epidemic from a village, after a sacrifice to the principal deity, the *Badwa* will visit all the sacred spots within the precincts of the village, chanting in a droning tone some invocation followed by drummers ; at each spot he will offer a little red ochre and a piece of cocanut, while at the principal entrance into the village limits, he will show by various antics and rapid gestures of hand and body with his back turned to the village, that the spirit to which the disease was due has been cast out into the adjoining territory. Another form of casting out an epidemic, is to sling some baskets, that have contained corn, and earthen pots that have been used for water, on a bamboo pole which is carried on the shoulders of men who run along the main road shouting at the top of their voices *todka ; todka*. On hearing the shouts, the next village sends out men to meet the procession at the boundary and these take over the burden and so the process is repeated. Thus the epidemic is carried away often to great distances, until eventually it is thrown into some stream or river which stretches across the path or is deposited in the forest. If no one from the next village is present to meet the procession at the boundary, the bearers are at liberty to deposit their burden in the village precincts. Sometimes a young he-goat is similarly carried on the shoulders of men or tied on to a light bier. The origin of *Bhilat Deo* worshipped by the Rathia Bhils is as follows :—

Bhilat Deo was the son of *Ruparela* Gaoli and his mother's name was *Mheinda Ranj*. He was a great simpleton when young, and in consequence was always being chaffed and made fun of by every one. Accordingly disgusted of life, he left his country and after wandering far and wide arrived in Gaur Bengal where he met a spirit *Karanda Jogan* by name who taught him magic. He studied the art to perfection and then returned to his native place to pass the

remainder of his days. On one occasion while many people were collected together, he took his harp and began playing when a snake came out of a mole-hill. The snake was so huge that the earth vibrated beneath the lashings of his tail. *Bhilat Deo*, however, caught the snake and took it to *Indar Raja* (Indra) who was greatly pleased to see his marvellous strength and power and ordered the people to reverence him as a *Deo* (god) in future; thus, his worship started. *Indar Raja* gave him *Bheru Deota* for a personal attendant, and also presented him with some cows as a reward of his merit. *Bhilat Deo* selected a spot under a tree on Mangalawri hill near Sendwa in Indore State, to settle. His cows increased daily in number, so much so, that he employed 900 cowherds to look after them, each man taking up his abode with his cows on a separate hill. Thus each of these spots represents the site of *Bhilat Deo*, the gods being kept under a tree or under some rude cover or in a small temple.

The Bhils have great reverence also for hill tops difficult of ascent, as being the abode of spirits which must be propitiated during sickness or calamity or to obtain offspring. In such cases, after the usual offering the forest is often set alight.

16. **Charms and witch-craft.**—Sometimes a newly-born baby has an elongated skull which may be due to the pressure of a too narrow opening of the womb. But the superstitious Bhils, seeing that the baby has a queer head believe it is an evil spirit and kill the baby at once, or if the newly-born baby looks queer and is queerly shaped, it is also killed thinking it is an evil spirit. It is reported that such murders are not rare.

The belief in magic and witch-craft is universal. Should any person fall sick without clear cause the *Badwa* is called in to exorcise the evil influences at work and discover the origin of the illness. With care he can usually discover some wretched old beldame who lives in the sick man's village and falling into a trance describes her accurately to the inquirers. The witch would be placed on one end of a yoke with cowdung cakes on the other in a pond. If she sank she was a witch. If she swam she was innocent. Red pepper would be put into her eyes; if no tears came she was a witch. In cases of serious illness it is almost invariably considered to be due to a witch taking possession of the patient's heart. A *Badwa's* charms are the only remedy. The sick man is often subjected to fumigation with the leaves of plants, a charmed thread is tied on his neck while a special dance in which the gods are invoked, is performed round him. He is then often carried from village to village. A few grains of *jowar* mixed with a copper coin are passed round the sick man's body and then sent to a *Badwa*. The *Badwa* then places over them a leaf of the *Butea frondosa* and floats the whole collection on water. He then picks out the grains and slowly drops them one by one into the water saying *bhut, deo, dakini* (witch), successively. When a grain floats he is thus able to determine which of these evil influences is at work, by the name which fell to the grain which floated. If it is determined to have been caused by a witch, he then repeats the process calling out the names of all the witches known to him. Should no grain float, the sickness is put down to natural causes. Another process is to take a handful of grain, chips of wood or leaves and throw them away counting each piece or grain as it falls and repeating this process for every known witch until an odd number falls to one of the names; the name so determined is that of the offender.

The belief in witch-craft is not only common amongst the Bhils but is widespread from the highest to the lowest classes. An excellent account of its prevalence in former times in Central India will be found in *Memoir*.¹ A reported case of witch-craft occurred nearly 45 years ago. In 1888 a Kachhi called *Rata* complained that his mother *Issa* had been, by order of the Rao of Bhatkahi, mounted on a donkey by a scavenger, beaten and turned out of the village as a witch; had then been made to drink water offered by a *mochi*, and beaten. The woman died from this treatment. Her body was burnt and the complainant's house broken into and Rs. 2,000 taken away. Complainant was away at the time, and on his return was told to leave the village.

Inquiry followed, on which the Rao admitted that *Issa* had been thus treated because she was a witch, and had caused the death of the wife and son of a rich Bania. *Issa* was 'named' as a witch and driven out of the village. She, however came back and was seized. It was alleged that on being seized she was said to have asked for a leopard to ride on but as no leopard was forthcoming they put her on the donkey, blackened her face, made her eat from a scavenger's hand and expelled her from the place. The Rao stated he himself heard her barking like a dog, and saw her making attempts to bite like one, and that after her expulsion she remained outside Bhatkahi for some days barking and flying at passers-by like a dog, till she died.

17. **Oaths and trial by Ordeal.**—Trial by ordeal is common, though in places it is now dying out. Some of the forms employed were the swallowing of live coals in the hand, piercing the palm of the hand with an arrow, eating poisonous herbs or fruits, etc. The simplest form consists in making the man take a solemn oath and then waiting for seven days. If (within this period) any mischance befalls him, or his family, or possessions, he is considered to have perjured himself, and the case goes against him. One common form of oath in such cases is this. The man is brought before the *Sarkari Gaddi*. This is simply a chair in the nearest Tabsil office. A clean white cloth is thrown over it and it is placed in full view. This represents

the ruler of the State and is in fact the emblem of authority. The man touches the chair with both hands and swears by *Barabij*. The Tarvi, who is administering the oath, turns to the east, and draws a circle on the ground with the point of a sword, commencing on the east and passing round by the north and west. Within this circle two lines are drawn joining north and south and east and west. The sword is then placed in the circle with its point to the east. The Tarvi then turns to the man and says: "If your cause is a good and true cause, raise *Bhav. snimatu* in your hand (*i.e.*, the sword)." The man does so exclaiming "*Barabij* visit me with evil within seven days (or other period) if I swear untruly." He then lifts the sword, bows and replaces it. The *Barabij* are the twelve *bij* or second day of each month, on which the new moon is usually first visible, and is a day held in reverence. Other oaths are laying the hand on a son's head and swearing; taking up one of the village gods (image) in the hand and swearing; in boundary disputes a goat is beheaded and then skinned and the skin placed on the man's head, who with his face to the east, swears his cause is good, and then drags the skin along the line of the boundary. Certain oaths are inviolable. One is that of the dog. A Bhil swears with his hand on a dog's head calling out that the curse of the dog should fall on him if he swears falsely. It appears that the dog as the companion of the god *Bhairon* is specially looked up to.

18. **Omens.**—These are very numerous. Some are given in the table below:—

A list of common omens observed at starting from the house.

No.	Omens.	Auspicious.	Inauspicious.	Time.
1	Beda-pani calls	On the left	On the right	Any time.
2	Cry of the Devi-Chiriyā	Left	Right	Day.
3	Caw of a crow	"	"	"
4	Cry of the Chiwara	Right	Left	Night
5	A deer crossing the path	Left to right	Right to left	Day.
6	Call of the Sara	Right	Left	"
7	Cry of the Saras	Left	Right	"
8	Cat crossing path	Left to right	Right to left	Any time.
9	Snake crossing path	In either direction	"
10	Cry of the Kanahari	Right	Left	Day.
11	Braying of a donkey	Left	Right	Any time.
12	Bellowing of a bull	From either side	"
13	Lowling of a cow	"	"
14	Hooting of an owl	Left	Right	Night.
15	Howling of a jackal	"	"	"

If a peacock cries before dawn on the third *Vaisakh* his cries are counted as it is believed there will be as many months of rain as there are cries. This is considered a most reliable omen. The appearance of a lark, calling just before rain is due, is a good sign. When sparrows constantly bathe in the dust, rain, even if just commenced, will soon cease. The croaking of frogs is another sure prediction of rain. The calls of certain birds are held to foretell success in the pursuit of game. Again when starting on an errand, if a horse should neigh on the right side, it bodes success; if on the left side, failure. It is usual to seek knowledge of the return of a member of the family. This is done by going to an old woman versed in such lore, who takes a winnowing fan which she balances on the little finger of her two hands, 5 grains of wheat or maize being placed on it. She then addresses the fan asking if the wayfarer will return. If the fan moves in answer all is well.

In former times when the Bhils seized a whole herd they sometimes offered a human sacrifice to the *Mata* of the thieves. They then killed the shepherd near the *Mata* as a sacrifice. The sacrifice was also conducted in another way. The shepherd was taken to the top of a steep hillock. His legs and arms were tied and he was rolled down the hill. These practices have been abandoned now. A common vow taken in honour of the *Mata* is to burn seven hills or to burn seven houses. When the grass in the jungle is dry they set fire in seven different places so as to destroy a great amount of grass in every one of these seven places. These acts are done presumably to obtain help of the *Mata* or to thank her for the success of a plundering expedition.

Appearance and character and social rules and customs.

19. **Physical type.**—There is a classic description of the Bhil attributed to the much maligned Bengali Babu: “The Bhil is a black man but more hairy. When he meets you in his jungle, he shoots you in the back with an arrow and throws your body into the ditch. Thus you may know the Bhil.”¹ Malcolm describes the plundering or wild Bhils who reside in the hills, as a “diminutive and wretched looking race whose appearance shows the poverty of their food; but they are nevertheless active and capable of great fatigue.”² The typical Bhil has a broad nose, thick lips which are ‘opened’ and the upper jaw is somewhat strong and prominent. He is dark but owing to much intermixture there are varying shades of darkness among the Bhils of different localities. Their hair is black but not woolly, and straight but not wavy. Many men, especially the young ones, like to keep long hair. The eyes are straight and usually black.

20. **Character.**—The Bhils in villages and in more settled parts have lost much of their suspicion of strangers and live like the lower castes. In the wilder and inaccessible parts they are still very timid. They vacate a village on the least provocation such as sickness or a rumour of probable harsh treatment. Though they have given up their predatory habits, the propensity to take up to plunder is still lurking in them. Some of them are enlisted in the Malwa Bhil Corps where they have proved faithful and loyal. They are capable of great endurance and it is recorded in 1858 some women of the Malwa Bhil Corps walked over fifty miles without once stopping, most of the way lying through heavy jungle. They are truthful unless spoilt by being ‘civilized.’

21. **Admission of Outsiders.**—A Chamar or Bhangi is not admitted to the caste. Others if eligible are admitted. Under Hindu influence, a ceremony has been devised for such admissions. The man is called before a *panchayat*. He then prepares a *tirth* as it is called of cowdung and Ganges or other holy water in a dish. This is presented to the *Patel* or *Tarvi* presiding. The *Patel* drinks it, and the same ceremony is then performed with the members of the *panchayat*. Rice boiled in goat’s blood is then presented and eaten. A payment of four or five rupees to the *Patel* concludes the ceremony; save for the inevitable carouse which winds up all Bhil ceremonies. Social position is determined by food, admittedly an importation from Hindu ceremonies. Thus the too near approach of a man of the sweeper or Gachha caste to food which is being cooked defiles it. If a man of these castes touches a Bhil’s clothes they must be washed.

Balais and Chamars, “whom” it is naively remarked “we must have about us to do the village work,” are allowed to take water from the village well, but not Gachhas or sweepers. It is amusing to note the Bhil observe untouchability. The high caste Hindu does not consider a Bhil an untouchable.

22. **Panchayat.**—Before the organisation of a judiciary in the States, the *panchayat* used to decide cases of all nature. The *panches* now try and decide such cases as pertain to the caste. Petty disputes are settled by the *panches*. The tribal constitution however appears to be disintegrating in recent times according to the report of some observers. The charge of the headman, the *Tarvi*, remains hereditary. The *Nat Patels* in former days exercised considerable authority but the tendency now is to reject their authority. Nobody seriously obeys the decision of the *panchayat*.

23. **Tattooing.**—This operation is generally performed at ten to twelve years of age on girls, on the cheeks, forehead, arm below the elbows, chin and wrists, and the calf of the leg and feet. Men are tattooed between 8 and 9, on arms, wrists and chests. Men operators tattoo men and women girls. The object of tattooing is said to be this. After death each individual is asked whether he has been pricked by thorns in the jungle; the presentation of these tattoo marks is considered as affirmative answer, without this they would have to be pricked with thorns in after life.³ Designs are numerous and are made to the fancy of the person operated on. Boys, it should be added, are in the habit of burning marks on each other on the back and wrist in either five or seven distinct places. This is done with a piece of smouldering cloth or the match of a match-lock. The custom is called *dhamla* and appears to have the same object as tattooing. Females are never branded in this way.

24. **Occupation.**—The Bhil always states that agriculture is his original occupation. If so, he can scarcely be credited with much recollection of it, as at this day he does but little cultivation even when every endeavour is used to induce him to settle and he is given land and pecuniary assistance. Tradition has it, however, that the Bhil at his creation was given by *Mahadev* a plough, sickle, harrow and a pair of bullocks and was promised that if he sowed two *Seers* of cereals he should reap two *Manis*. Gradually the States are getting the Bhils to settle and become regular cultivators and many now hold leases from the Darbar like ordinary agriculturists but as a rule on very easy terms. Where regular settlements exist the *Tarvi* or headman generally contracts for the revenue of the village making what he can out of

¹ Sir Michael O’Dwyer, *India as I knew it*.

² *Memoir* ii, 179.

³ C. E. Luard, *Tattooing in Central India*, Indian Antiquary, 1904.

the inhabitants. Cultivation is often done by outsiders who are paid a share of the produce. Sometimes a man agrees to work for 3 days for another, cultivating his own land on the fourth day. Hindu ideas as to propitious days, etc., have become general, with some modifications, in the observances followed. Thus before sowing a cultivator sets up a stone at the top of his field and anoints it with red lead breaking a cocoanut over it; this stone represents *Ganesh*. The evil eye is averted from crops thus. Two sticks are planted in the ground with a piece of conspicuous coloured cloth tied to them or heaps of stones are raised and white washed. The onlookers' gaze thus falls first on these objects. After the reaping is completed, the evil spirits are appeased by the offering of a cock and liquor. Before a well is sunk a stone is set up and anointed with red lead and propitiated with offerings, the stone standing in this case for the water deity of the locality.

Except in the case of such few who have taken to cultivation, the Bhils are still a wandering population and as a rule have no fixed village. Without migrating far away, they keep wandering within certain limits in the States of the Vindhya. Many find occupation in reaping the harvests on the uplands of Malwa from March to April. If the Bhils were encouraged to build *pacca* houses they would become less wanderers. Many of them, every third or fourth year desert their village and settle elsewhere. So long as they have the spirit of *wander-lust* they will never become good agriculturists. Some take up the work of village watchman and a great many are addicted to plunder and theft. One observer who has 22 years' experience among the Bhil writes that the majority of them go in for theft. A hundred years of peaceful rule in Central India has not completely reformed them and weaned them away from their former habits. They are no longer turbulent as they were in the days of unsettled rule in Malwa. But still they remain low and degraded. Malcolm wrote "that the common answer of a Bhil when charged with theft or robbery is 'I am not to blame; I am *Mahadev's* thief'. In other words my destiny as a thief has been fixed by God".¹

25. **Inheritance.**—Tribal custom determines inheritance. Of the property half goes to the youngest son, who is responsible for the payment of all expenses incurred on his father's *nukta* (the feast given after his death usually on the 12th day after). He has also to make provision for his sisters. The other half is divided between the elder sons. If they all live together, a very rare occurrence, they share equally in the property. In the case of the deceased being a *Tarvi* or headman, his position is assumed, not necessarily by the eldest son, but by the most fit, who is chosen by the *Panches*. He then becomes entitled to the usual rights pertaining to the position, as well as its responsibilities, such as entertaining strangers of position, etc. In the case of a *Tarvi* dying childless, his successor is chosen in the family. A widow is mistress of her husband's property for life, provided she conducts herself properly. It is not uncommon, however, to divide the property in order to prevent disagreeable quarrels. A daughter can under no circumstances inherit her father's property. Only those who are *sagotra* (of the dead man's sept) can inherit. If there are no heirs, the *Panches* consider the case, and no relatives being traceable, the property goes to the Darbar.

26. **Festivals, music and amusement.**—The Bhil observes the principal Hindu festivals. A mock marriage of two dolls representing the deities who control the rain is sometimes performed. Just before the *Holi* a great fair called *Bhagoria hat* is held. The men put on their best clothes and carrying bows and arrows dance in a circle; women cannot take part in it. If it can be called so, the drum is their chief musical instrument. On this three predominant notes are used; for Joy, Grief and Fear. For Joy the drum is beaten at both ends, for Grief only at one, the end being previously muffled by rubbing it over with moistened *Urad* flour. In the case of alarm it is beaten at both ends a continuous loud note being emitted while screams often add to the commotion. This note is at once picked up by the next village and in an incredibly short space of time the whole district is aroused, all gradually collecting at the spot where the first alarm was sounded. Cymbals of brass or pewter and bamboo flutes are also used. Dancing and singing form part of all important ceremonies, such as weddings and other festive occasions. In all mixed dances men and women dance in separate circles. Dancing is always performed in two groups, men in one group and women in the other. The movements are rhythmic and in many cases accompanied by the beat of sticks in time to the somewhat monotonous chant to which the dance is performed. A special performance takes place in *Holi*. A man is blackened with charcoal and dressed in a blanket and is called *Budelyu*, another man dressed as a woman being called *Raiyi*. These two dance while all sing obscene songs, much liquor is drunk and practically all present gradually become inebriated.

27. **Language.**—The Bhils speak Bhili and other cognate dialects which are detailed in Imperial Table XV. Whether the Bhils had a language of their own is now difficult to say. The Bhili dialect is mainly derived from Gujarati and is influenced by Malwi, Nimadi and other dialects of Malwa in accordance with the proximity of these to the Bhil tracts. Sir George Grierson is of the opinion that Bhili shows 'traces of a non-Aryan basis which are too few to be certainly identified. The basis may have been Munda or it may have been Dravidian—

¹ *Memoir* i, 526.

perhaps more probably the former—but has been completely overlaid by an Aryan superstructure.¹ It is now thoroughly an Aryan language. The same authority assumes early Dardic influence in the Bhil languages.

28. **Bhilala.**—The Bhilalas are closely related to the Bhils, Patlias and other tribes which inhabit the Vindhya and Satpuras. They have a considerable admixture of Rajput blood in them. They claim Rajput descent and are considered to be of higher status than their neighbours. The name of the tribe is said to be derived from *Bhilara* (or Bhilala). *i.e.*, those accused of being Bhils from *ara* a fault. They consider this appellation derogatory. They always style themselves Thakur, Bhumia, Rawat, Patel, Mukhi, etc.

The traditions of the tribe state that their Rajput ancestors lived at Delhi, and were Chauhans, members of the family of Prithviraj, the last Hindu king of Delhi. When the Chauhans were finally driven out by the Muhammadans² 200,000 of them migrated to Mewar and settled at Chittor in Udaipur State. On the capture of Chittor by Ala-ud-din in 1303 a large number fled to the Vindhya hills for refuge. Here they formed marriage connections with Bhil women and so lost caste. Their superior status is always admitted and they form the local aristocracy of the Vindhya, the Raja of Mandhata, as he is called, being the head of the clan. Malcolm says that in his day the Bhilalas and Sondhias were the only robbers in Malwa whom no traveller could trust, as no oath, however sacred, restrained them.³ He concludes with the remark that they combine “with the pride and pretensions of Rajputs the cunning and roguery of the Bhils,” while they are destitute of any of those feelings of chivalry which occasionally redeem the vices of true Rajputs. In the beginning of the 19th century some members of the clan rose to importance during the confusion which the Pindari depredations caused in Central India. Nadir Singh, a Bhilala of Jamnia village near Mandu, assisted Jaswant Rao Holkar in his campaign to recover the family estates. Nadir Singh Bhilala’s name soon became a terror in southern Malwa. By 1818 he had collected a body of 200 horse and 700 foot, and his power was such that Hate Singh, a Khichi Rajput, Thakur of Naulana, actually consented to dine with the Bhilala Chieftain, in order to save his estate from ravage. When Sir John Malcolm asked Hate Singh about this, he replied that his having dined with Nadir Singh did not degrade him, but raised the Bhilala. There are now ten estates held by Bhilalas under the British guarantee and others held without a guarantee, from Dhar and other Darbars.

The tribe is divided into two main sections but no marriage distinctions are made, the *Badi* and *Choti jats* only differing as regards eating and drinking, the septs in the *Badi jat* never eating fowls or drinking liquor. In marriage relations they are on the same footing as the septs in the *Choti jat*. As regards septs the usual difficulty has been experienced in obtaining a list. No two persons ever give the same name or the same number of septs. Lists are given in another section. From these lists it will be seen that practically no septs are now traceable to totemistic origin, though possibly there were totemistic reasons for many names; others are Rajput names; and many local.

The Bhilalas form one big endogamous group divided into 42 septs which are exogamous. No two members of the same sept can marry. Sexual license before marriage is not recognised at all. Where connection has been made with a man of superior caste, such as Rajput, Brahman or Bania, the children may be admitted to the Bhilala caste but not if the girl has lived with a low caste man. The marriage ceremony is like that of the Bhils with greater importation of Hindu customs. The practice of *ghar jamai* abduction and the choice of husband are also in vogue. Widow re-marriage is recognised among the Bhilalas but the higher classes now prohibit it owing to Hindu influence.

They cremate their dead. In matters of religion they consider themselves Hindus. And though they undoubtedly have as much claim to be considered so as members of the lower classes of the recognised Hindu community, they borrow a certain number of the more animistic practices of their Bhil neighbours. They consider the deity *Orkar Mahadev*, on the island of Onkarnath in the Narbada, as their special tutelary god, while they accept all the other members of the Hindu pantheon. They also reverence the tombs of Musalman saints. In fact they are in all essentials Hindus and they are admitted to be so as shewn by their being allowed to enter temples and generally take part with Hindus in all religious ceremonies. Priests are not necessarily employed by them, although when possible Brahmans are engaged, particularly by the well-to-do such as the Bhumia land-holders. An elderly and respected member of the family can always act as *Pujari*.

Once they were as predatory and turbulent as the Bhils. They are now peaceful agriculturists and their position more and more approximates to that of the lower Hindu castes. The land-owners have considerable pretension to be ranked as Rajputs and are slowly transforming themselves into well-known Rajput clans.

29. **Patlias.**—The Patlias are principally found in Jhabua State and in small numbers in Ali-Rajpur, Dhar and other minor States of the Southern States Agency. They are almost on

¹ *Linguistic Survey of India*, Vol. I, 178-179.

² By Muiz-ud-din in 1192 A.D.

³ *Memoir* i, 425, ii, 128.

the same footing as the Bhilalas and have an admixture of Rajput blood in them. In appearance there is little to distinguish them from Bhilalas. The name Patlia is derived from *bille* or "polluted" owing to their being outcasted.

The tradition connected with the formation of the caste is this :—

Originally the caste being a section of the Paramara clan dwelt at Abu, but were driven by famine to migrate to Gujarat and settled at Pavagarh in the Panch-mahals. Here one day at the *Navaratri* festival the goddess *Kali* joined the women of the clan in chanting *garbhas* (songs) in praise of *Devi*. The great beauty of the goddess struck a barber who at once rushed off to the chief of Pavagarh, Parthi (Prithvi) Singh, and informed him of his find. The Raja fired by the account hurried to the spot and without beating about the bush at once advanced to the lovely dancer and requested her to become his wife, offering her the rank of *Patt-rani*. The goddess was highly incensed and cursed the Raja and his people, vanishing as the last words of her curse fell on the Raja's ears. From this moment misfortune dogged the steps of the clan, a severe famine eventually forcing them to migrate once more. They retreated to Nalwai village in the Dohad district. Here one of the clan driven by hunger killed a *roz* (*nulgai*, *Bos elephas tragocamelos*) which they ate. This act of sacrilege outcasted this section of the clan and they were stigmatised as impure (*bille*) becoming known ultimately as *Patle* or Patlia. They were forced to leave Nalwai and took to the hills. Another tale narrates how, when thus driven into Gujarat, they accepted food of the Tentiya Rajput clan, of spurious origin, and hence lost caste. Apart from the legend, there is no doubt that they came originally from Gujarat as the connection with this district is still kept up, serious caste matters being to this day referred to the *Patel* of Gangedi village in Gujarat.

The Patlias form a single endogamous group or tribe divided into exogamous septs. Nearly 12 sept names have Rajput appellations with local affixes such as *Pipria Parmar* called after Pipria village in Baria State. *Tandia Parmar* called after Tanda village in Amjhera district of Gwalior and so on. This supports their Paramara descent.

Their marriage customs are like those of the Bhilalas. The practice of *ghar jamai* is prevalent. It is not uncommon for a man to work for his bride acting as the servant of his father-in-law. Seven years is the usual period. No payment is made for the bride in this case. After 7 years the couple are given a separate house and means to cultivate whereas up to then clothing and food only are given. If no child is born after twelve months from their taking up a separate residence the usual marriage ceremony is performed at the expense of the girl's father. If the couple elope before the seven years is complete, the man has to pay a bride price. Abduction and elopement are also common in obtaining a wife. The remarriage of widows is practised. All ancestral property is divided equally between the sons. In the case of a joint family, even where one individual is a larger contributor, the total earnings or belongings are held to belong equally to all. In the case of a hereditary *Patel* or *Tarvi* the son (if any), best qualified, becomes *Patel* and receives the customary dues, and also any *inami* land which belongs to the *Patel-ship*; these things are not considered common property. A widow with no male heir is sole mistress of the property which passes on her death to the nearest of kin. In cases where she has a son, who is living apart from disagreement, the widow is held to be a son for the purposes of inheritance and gets an equal share with her son or sons. Daughters have no rights of inheritance. Where there is no next-of-kin the property passes either to the Darbar or the *Panches* of the village.

Oaths, omens and charms followed and practised are similar to those of the Bhils. These are carried out by the *Ladwas* who become "possessed" under favourable conditions and foretell the future; the exorcising of deities of disease is one of their special functions. In the case of cholera the *rogta* procession or procession of health is practised. The *Badwas* are called in and all collect at a central spot in the village. After a time they become "possessed" and heave and sway about and commence to chant songs in praise of the goddess continuing to sing throughout the night. Early in the morning they take some parched gram and some balls of dried gram flour and a thread of many colours, a *tiki* (the piece of tinsel worn on the forehead by women) and some boiled wheat and the head of the freshly killed cock. These are placed in an earthen jar broken into two halves. Some liquor is poured over these objects and they are placed in a small wooden toy cart. This is dragged to the border of the village, the *Badwas* following dancing and twisting and heaving under the influence of the goddess. At the border the cart is taken by men from the next village and similarly passed on to the next. When dysentery becomes epidemic, another process is followed called *toika*. Every case has an inverted earthen jar full of burning cowdung cakes placed on a brass dish put below the patient's bed. In the case of an ailing child the mother makes a leaf dish and in it puts a few hairs from her own head, some salt and chillis, and a small lamp of flour. Cowdung cakes sometimes take the place of the leaf dish. This dish is then carried up to the sick child and passed down seven times over it from the head to the feet; it is then taken at once out of the house and put down in a spot where three thoroughfares meet. Another cure consists in placing the hair, salt and chillis with some wheat in the fold of her head-dress passing this over the child. Another method is to make two dolls of coloured cloth, swing these above the child and then cast them into a running stream. When a child suffers from the evil eye, an

earthen pot is made red hot and put into a dish half full of water, mouth downwards, the bubbling and steaming which ensues carries off the evil effects.

In all important ceremonies Brahmans are employed. The Patlias worship the Hindu deities but in particular *Kalika Devi*. The reason for this is that at Abu they were special worshippers at her shrine and they believe that it was through her the Ponwar (*i.e.*, Paramara) Marathas got Dhar. The minor deities are identical with those of the Bhils but they have two warrior gods, *Nahar Singh* and *Makua Paramara* who are much revered. They were certainly former leaders of the tribe. The dead are cremated and the usual ceremonies are observed.

The Patlias are prone to wander and cultivate only to a small extent. Like the Bhils, dancing, singing, and a good deal of liquor-drinking are their chief recreations. They appear to join in Bhil games to a certain extent. The recitation of the past glories of the tribe is done by their special Bhat who comes over from Gujarat yearly. He will not feed with them or take food prepared by them.

30. **Rathia.**—The Rathias are a section of the Bhil tribe. They have been exclusively returned from Barwani State, numbering 37,260 (19,028 males and 18,232 females). They appear to have acquired their appellation owing to their long sojourn in the Rath country which now forms a great part of Ali-Rajpur State. The Rathias of Barwani date their advent from more than a century and half when one Bhima Patel and others came from Rath and settled at Pati in Barwani State in the time of Rana Chandra Singh. Then the country was full of forests and suited to Bhil immigration.

Marriage ceremonies are simple. At the time of betrothal the boy's father with some relatives goes to the girl's house and presents a small amount to the girl. Then they eat and drink together. At the time of marriage the bridegroom's father accompanied by his male and female relatives goes to the bride's house and pays Rs. 50—60 to her parents. The bride and bridegroom are made to sit together, while the men and women sing and dance to the strains of Bhil music. No elaborate ceremony is performed. Re-marriage of widows is permitted.

Brahmans are not employed for ceremonial purposes. A casteman of the tribe performs the ceremonies. Their religious beliefs, etc., have been noticed under the Bhils. They are indifferent agriculturists like the Bhils. Some work as labourers. They are usually distinguished by their rude dress. The peculiar usage in respect of dress is the loin cloth which is allowed to hang low down behind almost to the knees and flap in the wind like a tail. They are always armed with bows and arrows.

31. **Mankar.**—The Mankar Bhils have been principally returned from the States of Indore, Dhar and Barwani. A class of Bhils famous as trackers, they now form a separate group. The Mankars are also called *Dhankawas* by other Bhils but are amongst themselves styled *Nahals* or *Naik*. The name Mankar is an occupational term, these men being under the orders of the village headmen; the term *Dhankawas* is from *Dharmukh*, a bow. The term *Nahal* means simply 'one of mean appearance'. The title of *Naik* was conferred on them by the State authorities in early days. They say they are the descendants of Rajputs and Bhil or Bhilala women. They form two endogamous groups with twelve exogamous septs, the *Chokaria* (or superior), Mankars and the *Nahal* Mankars. Some of the septs are totemistic. Thus:—

Mori.—Called after peacock. The sept worship the peacock and never injure it.

Sanyar.—Called after a goddess of this name whose temple is at Bal-Kuwan village, eight miles from Barwani. The goddess rides on a cat and this animal is revered and never injured by them. Any vessel from which a cat has drunk is at once put aside as sacred and never used again.

Soliya or *Khas Soliya.*—Called after a bird of this name. This bird is never injured and is worshipped. Any injury done is believed to be punished by the blinding of the man doing the injury.

Semlia.—Called after the *semal* tree (*Bombax malabaricum*) which they reverence and never injure.

32. **Tarvis.**—The Tarvi Bhils of Barwani do not return themselves as Tarvis and hence the Caste table does not contain them. Two septs of these Bhils came into Barwani. One from the Rath and another from Dohad in Bombay Presidency. The *Rathvi* Tarvis speak Rathvi; the others Bhagori, a corrupted form of Gujarati. They are divided into two endogamous divisions, *Tarvis* and *Natra-Tarvis*. Many of the septs are totemistic. Marriage must take place within the division but outside the sept. Marriage with a girl of the maternal uncle, maternal aunt, mother-in-law or sister-in-law is prohibited. Exchange of daughters is practised. Sexual intercourse before marriage is tolerated, is not considered disgraceful and is often encouraged. Marriage ceremonies are simple. As soon as the girl is found the man proceeds to the girl's house and takes a pitcher of liquor with him. Omens are carefully considered and a bad sign on the road is sufficient to break off the wedding. When the betrothal takes place a feast is held of all relatives. The day for the marriage procession is settled and the wedding is celebrated with much singing and consumption of large quantities of liquor. Widows are allowed to remarry and divorce is a simple matter.

They do not employ Brahmans. They do most of the ceremonies themselves. *Badwas* are requisitioned when necessary. Like other Bhils the Tarvis are animistic in their beliefs. *Hanuman* is their tutelary village deity and they observe Hindu festivals. They cremate their dead.

33. **Barela.**—The Barelas have been exclusively returned from Indore State. A detailed account of them could not be obtained from the State authorities. It is hoped the gap in the knowledge will be made good before the next Census.

SECTION B—I.

A LIST OF BHIL SEPTS WITH EXPLANATIONS OF THEIR ORIGIN WHERE KNOWN.

No.	Name of Sept.	Story as to Origin.	Reverence paid to special objects.
1	Kanbi . . .	The story goes that in former days one of their ancestors was given the nick name of <i>kanbi</i> by the bride's female relatives (<i>wiwahān</i>) for climbing into a <i>kanli</i> or <i>kalam</i> tree (<i>slēp-hegynē parvifolia</i>) during the marriage ceremony.	They worship the <i>kalam</i> tree and never cut it down.
2	Kātiya . . .	Takes its name from the dagger	At the commencement of the <i>bāna</i> ceremony a dagger is worshipped and is held by the bridegroom throughout the marriage.
3	Barberia . . .	Named after the <i>Barbet</i> (<i>Dalbergia Lanceolaria</i>) tree.
4	Katāra . . .	Also named after the dagger
5	Dāngi . . .	Called after the <i>dāng</i> or <i>lāthi</i> often carried as a weapon of defence.	Bamboos are worshipped in marriage ceremonies and are never cut by them.
6	Kanāsia . . .	No explanation
7	Kalāra . . .	Called after the <i>pīn</i> leaf
8	Kishori . . .	Named after the <i>Kishori</i> (<i>Butea frondosa</i>). They are an offshoot of the <i>Balwai</i> Sept.	Worship it at marriages. They never place its leaves on their heads.
9	Kikria . . .	Called after the creeper of this name (?) of which the root is eaten.
10	Kirādia . . .	No explanation
11	Kodia . . .	Originally were of the <i>Bhūria</i> Sept. This offshoot is called after the <i>courie</i> shell.	No female of this sept wears <i>couries</i> .
12	Bhūria . . .	The "Brown" sept said to have obtained the name from an ancestor who went about covered with ashes. The proverb below relating to this clan, taken together with the story of the ashes, seems to point to a <i>sādhu</i> ancestor. The proverb runs:— <i>Bhuria bhatak, tumdi chatak, tumdi meni hānp nikalyo, Bhuria, keve, mhāro bāp nikalyo.</i> Bhuria wanders a gourd (<i>kamandalu</i>) split and out came a snake, Bhuria cried, "My father came out thence".	The brown gourd of which the <i>tumdi</i> is made is never eaten by them; nor is any ashy-coloured snake killed by them, both being objects of worship.
13	Chawān . . .	Pseudo Rājput origin from Chauhan
14	Kohwād . . .	No explanation
15	Kecbria . . .	This sept does not belong to the Jhabua Bhils, but is met with sometimes.
16	Kharādi	They never eat the fish called <i>Dhoka</i> .
17	Khādia . . .	Called after the reed <i>khadi</i>
18	Khapedia . . .	No explanation
19	Khadedia . . .	A corruption apparently of <i>Gadaria</i>
20	Chārel . . .	The story asserts descent from a Chāran

SECTION B—I—*contd.*A LIST OF BHIL SEPTS WITH EXPLANATIONS OF THEIR ORIGIN WHERE KNOWN—*contd.*

No.	Name of Sept.	Story as to Origin.	Reverence paid to special objects.
21	Bilwāl . . .	Called after the <i>Bel</i> (Aegle marmelos) . . .	They worship the <i>Bel</i> tree and use its leaves to predict the future at marriages. Four leaves are placed on little heaps in four separate spots. On them some grains of rice are strewn and they are worshipped. An old man then watches the leaves and by their movements predicts good or ill fortune to the newly married couple.
22	Khokar . . .	Named after a broken earthen vessel. No intelligible reason is given for the name but 'khok'ar' is the usual term applied to a broken <i>ghara</i>
23	Khota . . .	Not a local sept though members of it come to Jhābua.
24	Ganāwa . . .	Called after the <i>Ganiar</i> tree (cochlospermum gossypium).	The tree is an object of worship at marriages and is never cut.
25	Camār . . .	A tale is told of an ancestor who was called <i>gan-wār</i> or fool because he lost his oxen and was obliged to drag the <i>pathār</i> over his field himself.	The sept worship a log or trunk of a tree.
26	Garwāl . . .	Named after the lizard so called <i>Garwāl</i> , <i>Ghar-wāl</i> or <i>Gharoli</i> .	An effigy in flour of the lizard is worshipped at marriages and the real animal is never injured.
27	Ganād . . .	Called after a village
28	Ginwāl . . .	Not local, but members are met with
29	Gundia . . .	Called after the <i>Gundi</i> tree (cordia)
30	Nināma . . .	Called after a <i>razai</i> or quilt so named, apparently, but explanation is not clear.
31	Bhūsa . . .	Not local sept
32	Gelot . . .	Pseudo-Rājput, Gahlot
33	Rāwat . . .	The story runs that an ancestor was beaten by his female relations with a churning staff (<i>rawai</i>) when he was rescued by his bitch.	A bitch is worshipped at marriages
34	Silot (or Helot) . . .	Called after <i>Sela</i> (or <i>Hela</i>) thread used in making rope.
35	Goyal . . .	Called after the "Goya" a place where the cattle are herded outside a village before going to graze.
36	Gohari . . .	Not a local sept but occasionally met with
37	Narwāyā . . .	Ditto
38	Pārgi . . .	The hunting section (<i>pārgi-pārdī</i>). The crab is their special object of worship, an ancestor, the story goes, being miraculously saved by this animal. He was taking home some meat when he was accosted by an official. The Bhil who had stolen the meat was at the time resting by a stream. He said he had only crabs in his wallet. The official insisted on looking and to the Bhil's surprise his wallet was full of crabs. So the legend runs.	This sept worship the land crab (<i>kel'di</i>) at marriages. Some rice unbroken and white grain is put before a crab. If it seizes a whole grain good luck will attend the couple. If it takes a broken grain or has an injured limb bad luck will follow.
39	Nisarta . . .	An offshoot of No. 38	Also worship crabs (or an effigy of a crab made in flour at marriages).
40	Meda . . .	An offshoot of No. 38, called after the <i>meda</i> tree	Also worship the crab. The bride takes a crab home on the completion of the ceremony wrapping it up in her <i>lugra</i> . Crabs are never killed.
41	Chanāo . . .	Not a local sept
42	Charpota . . .	Called after the <i>Charpoti</i> (?)

SECTION B—I—*contd.*A LIST OF BHIL SEPTS WITH EXPLANATIONS OF THEIR ORIGIN WHERE KNOWN.—*contd.*

No.	Name of Sept.	Story as to Origin.	Reverence paid to special objects.
43	Amlīār . . .	Called after the poppy (<i>amal</i>)
44	Rāthor . . .	Pseudo-Rājput	Worship the <i>Pipal</i> tree (<i>ficus religiosa</i>).
45	Chamka . . .	An impossibly fanciful tale is told of a party of this sept coming from Baria near Dohad to a marriage. At the Khān river they were startled (<i>chamal:</i>) by a large flock of <i>laoda</i> birds who rose suddenly on their approach. Their surprise was witnessed by the others and hence they obtained this name.	They worship the <i>Sehati</i> (an animal?).
46	Parmār . . .	(Pseudo-Rājput I expect.) The legend connects the name with the goad (<i>Parāna</i>).	Worship the <i>Parāna</i> or goad of which a drawing is made on a wall in turmeric at marriages.
47	Pachāya . . .	Said to be connected with <i>Panchīyat</i> . Not properly explained.
48	Hatila . . .	No explanation
49	Chaodia . . .	Legend attributes descent from a Rājput of the <i>chaoda</i> clan.
50	Chudādia . . .	Called after lac bangles (<i>chuda</i>)	Lac bangles are worshipped at marriages and no females of this sept ever wear them.
51	Changod . . .	Called after a bull's horn	A bull's horn is worshipped at marriages, the sept never cut the horns of cattle.
52	Chhaiya . . .	Not local
53	Jharnia . . .	Ditto
54	Tokria . . .	Claim descent from a Bhilala of Kathiwāra estate near Ali-Rajpur who settled at Tokria-jiran village of Ali-Rajpur.
55	Masānia . . .	An offshoot of No. 54. The legend runs: they, an ancestor being hard put to it, used fire from a <i>mas'in</i> to cook with.	Worship bamboos at marriages and never cut them down.
56	Dabi . . .	Not explained said to be connected with <i>dāwa</i> , <i>i.e.</i> , the left hand.
57	Dodigar . . .	Called after the heads of maize known as <i>Doda</i> (?).
58	Machhār . . .	Called after mosquitos	This sept never injures goats of a white colour.
59	Dāmar ¹ . . .	No explanation
60	Bāmnia . . .	Corruption of Brāhman, due apparently to a claim of Brāhman descent.	Worship the <i>kari</i> tree (?) at marriages.
61	Dindod . . .	Called after the water-snake known as <i>dindu</i> (?)	Worship and never injure the <i>dindu</i> .
62	Tād . . .	Called after the <i>tādi</i> (palm) tree
63	Arad . . .	Called after the grass known as <i>arad</i> or <i>kasai</i>
64	Tadela . . .	Not local
65	Dalma . . .	Said to be called after the <i>dans</i> , an insect . . .	Never kill the insect known as <i>dans</i> (?).
66	Bāria . . .	No explanation
67	Deoda . . .	Ditto

¹ See songs for the migration of this Sept.

SECTION B—I—*contd.*A LIST OF BHIL SEPTS WITH EXPLANATIONS OF THEIR ORIGIN WHERE KNOWN—*contd.*

No.	Name of Sept.	Story as to Origin.	Reverence paid to special objects.
68	Māoda . . .	Offshoot of No. 67. No proper explanation . . .	They worship the earthenware dish called a <i>Taodi</i> , and if one breaks carefully collect the pieces and bury them.
69	Singād . . .	Called after horns	Worship a bull's horn at marriages and never cut the horns of cattle.
70	Paggi . . .	No explanation
71	Panadā . . .	Said to be named after a fire in which part of the sept was once burned (<i>Panaja</i>).
72	Palāsia . . .	Called after the <i>Palasia</i> or <i>Palhadi</i> tree (<i>Butea frondosa</i>).	Never cut the tree and worship it at marriages.
73	Paredia . . .	} Not local
74	Barjor . . .		
75	Wagdia . . .		
76	Budad . . .		
77	Bhagara . . .	Called after "pieces of bread" or <i>bhagra</i> (<i>tukra</i>).	On the completion of the wedding, broken-up bread is distributed to all.
78	Bhateria . . .	} Not local
79	Bhardia . . .		
80	Bhābar . . .	A legend says the ancestors of the sept once feasted on an ass, but when taxed with it said it was a <i>Roz</i> (<i>nilgai</i>). A proverb runs:— <i>Bhābra bāj khāya gaddha ne mīne Rozh.</i> The Bhābars roasted and ate an ass and considered it a <i>nilgai</i>
81	Rāna . . .	} Not local
82	Bhedi . . .		
83	Makwāna . . .	Called after the spider (<i>makwa</i>)	An effigy in flour is made of a spider and worshipped at weddings. Members of this sept are credited with the power of healing the irritation made by certain spiders, by simply touching the spout.
84	Mori . . .	Called after the peacock (<i>mor</i>)	At marriage an effigy of a peacock is worshipped. This bird is never molested by the sept.
85	Makhodia . . .	Apparently called after a toret (<i>makhodia</i>) but origin is not traceable.
86	Māl . . .	No explanation
87	Māwi . . .	Ditto
88	Māliwād . . .	Called after the jungle (<i>māl</i>). No origin given
89	Mohania . . .	Not explained but I fancy it is connected with the tree mentioned in column 4.	They worship on the first day of the <i>Bāna</i> ceremony a <i>muni</i> tree. They never cut it.
90	Munia . . .	Called after the <i>munj</i> or <i>moini</i> tree (<i>odina wodier</i>)	Worship the <i>moini</i> tree at marriages and preserve it.
91	Lakhma . . .	Offshoot of 90. No explanation forthcoming. A legend refers to the care (<i>lakhan</i>) used by an ancestor in his work, as the origin.
92	Wasunia . . .	No explanation

SECTION B—I—concl'd.

A LIST OF BHIL SEPTS WITH EXPLANATIONS OF THEIR ORIGIN WHERE KNOWN—concl'd.

No.	Name of Sept.	Story as to Origin.	Reverence paid to special objects.
93	Maida . . .	Called, it is said, after curds (<i>mahi</i>)
94	Jhodia . . .	No explanation. Is an offshoot of No. 93
95	Mena . . .	Called after <i>mena lodra</i> a form of <i>lodon</i> (<i>pas-palum stoloniferum</i>) which is said to cause a form of intoxication (<i>mena</i>) when largely eaten.	<i>Kodon</i> is never eaten now by the sept, but balls made of it are worshipped at marriages.
96	Mandor . . .	Not explained
97	Arjaona . . .	No explanation	Do not kill goat themselves but will eat its flesh.
98	Osāri . . .	Apparently named after the <i>osāri</i> (<i>wasāri</i>) or verandah of a house, but is fanciful and not obvious.
99	Batedia . . .	Not a local sept
100	Rāwal . . .	Not given
101	Wadkhia . . .	Ditto
102	Suwaar . . .	Called after the wild boar	Never kill and eat pig and worship an effigy of this animal in flour at weddings.
103	Wania . . .	Descended from a Bania (<i>Wania</i>) of Rambhāpur who had a Bhil mistress.
104	Wākhla . . .	Called after the "flying fox" (<i>Pteropus medius</i>)	This bat is never molested by the sept.
105	Bāhaiya . . .	} Not local
106	Bagol . . .		
107	Sastria . . .		
108	Surlānia . . .	} Not local septs
109	Solanki . . .		
110	Sapnia . . .	Called after a snake
111	Solia . . .	Also claim Solanki descent as 109
112	Māoda . . .	} Not local septs
113	Uāhāwā . . .		
114	Kāmlia . . .	Not explained clearly but seems connected with blanket-making.
115	Kandor . . .	Not explained
116	Waderi . . .	Said to be from <i>Waderi</i> a brawl, their ancestor being killed in one.	They worship the sword.
117	Navi . . .	Barbers
118	Kalāwa . . .	No explanation
119	Hāda . . .	Said to be connected with <i>handi</i> , a vessel, but looks like Pseudo-Rājput.	Worship a newly made <i>handi</i> at weddings.
120	Dholi . . .	Originally <i>katāras</i> , but became drum players
121	Gādria . . .	Not explained
122	Jhāla . . .	Looks like Pseudo-Rājput but is said to be connected with the cultivation of grain in soil made by burning down trees. This cultivation is called <i>walri</i> .	<i>Wālri</i> grain is never sown by the sept, and they say no member of this sept can eat it without suffering. As proof the case of one Mānji Dāmar of Bihār Village in Jhābua was quoted. He suffered after eating from a swelled body and was only cured after 7 days' worship of his goddess with <i>walri</i> grain offerings.

SECTION B—II.

THE BHILALA SEPTS.

Badī Jat.

1. Rāwat This sept claims Baghela Rājput origin. They state that their ancestors came to Mewār, whence some of the clan went to assist the Rājā of Ali-Rājpur. Owing to their mixing with Bhilālas they lost caste.
2. Chokhla Wāskala This branch of the *Wāskalas* claims Rāwat descent.

NOTE.—In this account only these two septs and not as usual four are given in a superior status. They do not drink liquor or eat fowls. As regards other customs they are on the same footing as the remaining septs.

Chhoti Jat.

3. Wāskala An offshoot of the *Chokhla* Sept. A member of that sept broke the rule regarding wine and fowl's flesh and his descendents were degraded.
4. Bhaidia Local: From the Bhaidia hills, a range in Ali-Rājpur State.
5. Solia Local: From Solia Village in the Kanas *tahsil* of Jhābua State.
6. Jamra Local: From Jamra Village in Jobat State.
7. Kaochha Called after the *lonch* creeper.
8. Nigwal Takes its name from the occupation of its members who extract the "toddy" palm juice called *nigal*.
9. Rāthor Claim Rājput descent.
10. Bandol No explanation.
11. Sastia Local: From Sastipura Village in Bagh *pargana* of Gwalior State.
12. Ajnāria Called after the *Anjan* tree (*Hardwickia binata*) which they revere and never injure as being the home of their tutelary deity.
13. Masania An ancestor was connected with the upkeep of a crematory (*masan*).
14. Kiradia No explanation. Apparently connected with *kirad*, meaning a valley.
15. Gadaria No explanation.
16. Arwadia No explanation.
17. Chomalkha No explanation.
18. Chauhān Claim Rājput origin.
19. Tadawala Offshoot of No. 18, not explained.
20. Changod Offshoot of No. 13 called after the founder, Changa by name.
21. Randha Local: From Ranada Village in the Bori estate in Jhābua State.
22. Mujalda Not explained.
23. Kanasia Local: from Kanas Village in Jhābua.
24. Avasia Local: from Avasgarh, the old capital of Barwāni State.
25. Māli So called from the founder being a *Māli* by caste.
26. Bāmnia A corruption of Brāhman. Claims descent from girl who was a Brahman's mistress.
27. Wania Descended from a Bania, one Suktal of Ghora Village in Jobat, and a Bhil girl who was his mistress.
28. Wiskia Local: From Wiskiapura in Dhār State.
29. Mori Local: From Moripura in Tānda *pargana* in the Amjhera district of Gwalior.
30. Dāwar Not explained.
31. Dodwa Local: From Dod, a *pargana* of the Chhota Udepur State (Bombay).
32. Chamka Not explained.
33. Bhābar Not explained.
34. Guthria Not explained.
35. Sanplia Not explained.
36. Semlia Called after the *Semal* tree (*Bombax malabaricum*), the home of their tutelary goddess. They always worship under this tree, and never injure it.
37. Dharwa Local: Originally from Dhār State.
38. Ohariya Local: From Oharan Village in Ali-Rājpur State.
39. Jobtia Local: From Jobat State.
40. Devada Rājput [*Deora*] descent is claimed.
41. Nargawah Local: Said to be derived from Narbadā, the sept living on its banks.
42. Bhaonra Not explained.

SECTION C.

SPECIMENS OF BHIL SONGS.

I have selected these songs out of a number collected at various times. They are ordinary examples of the lays chanted to the Bhils in Villages.

In recording them the actual words as used were put down most carefully, the class of letter, cerebral, palatal, etc., actually used by the singer being noted.

The language is more mixed than the spoken dialect of any one district, as was to be expected in song, and also from the fact that the singers have gathered their lays from various sources.

The language, however, shews clearly its adherence to Gujarātī rather than Mālwi, and generally to the standard form common in Mahikantha as given in Mr. Thompson's grammar, and to the dialect of Khāndesh.

Without going into details it may be noted that the genitive ordinarily ends in *na* or *no*, though the Rājasthānī form in *rā*, and even the form *kerā* (common in the *Rāmāyana*) is met with, we have *maro*, my; *te.a*, of him; *soro*, *sorī*, boy, girl; *gher*, house; *jā-je*, please go; *dhāmīyo*, hastened; *dodyo*, ran; *kuno*, *kuṃyo*, who, whose; *hāt* (for *hāth*), hand; *kim*, why; *ne*, and; the infinitive in-*wā*, as *khelwā*, to play.

For *har* we have *se* derived from *chhe*, which is also used itself.

A common word used for good, excellent, thoroughly, and indeed generally as an adverb implying fitness or completeness, is *rudo*, a word met with in the *khānwā* form of Gujarātī.

Of other changes, h stands for s, s for ch or chh, d for r, k for g, and so on as is usual.

As those reading these songs will be conversant with Hindi, only a few notes are appended here and there.

Of the songs given the first deals with the migration of the *Dāmar* Section of Bhils from Gujarat to the South of Central India, the second with an irruption of *Bārīya* Bhils, the third with one of the tribal demi-gods, and the fourth with the custom of marking the *tika* on the forehead of the Jhābua chief at his succession.

I should add that the historical nature of these songs has paled before their supposed efficacy as charms, and they are commonly chanted round invalids, especially in cases of epidemic disease. They are sung to the accompaniment of *dhāk* and *kānde* or drum and bamboos.¹ Such singing being called *mandor karwa*.

¹ The *kānde* is a bamboo which has been split and notched over which another is rapidly rubbed producing a monotonous sound.

No. I.—The Song of a Kachumar Damar Bhil.

[N.B.—Words in brackets are not in text.]

He ine ine range voravalā devu veṇḍdvu	I make (my) obeisance to my gods whom all worship—Hāṅre ¹ , etc.
He devu ¹ devuṇṇ melāvo—Hāṅre ke mālan meravo—Hāṅre ke mālan meravo.	I worship all the collective body of the gods—Hāṅre, etc.
He ine Dholkānī dharti māṅ Uharā Buharā Dāmar	In the land of Dholka (lived) these two Dāmar (Bhils), Uharā and Buharā (by name).
He Dāmar māḷūna, dhāyā ² ne—Hāṅre, etc.	These two Dāmars were satiated with riches—Hāṅre, etc.
He Dāmar sāṅḍini ³ havelire huṅānā naliyā—Hāṅre, etc..	The Dāmar's house was of silver (roofed with) tiles of gold—Hāṅre.
Ae āyā maṅgalwārne dādā ⁴ —Hāṅre, etc.	One day (it fell upon) a Tuesday—Hāṅre.
He Dāmar sikār khelwā jāyase ḍuṅgarnī dhartimāṅ—Hāṅre, etc.	These Dāmars went hunting on the hills—Hāṅre.
He devatā nawalākhe sorī sere ⁵ . Meghūnī soriyāṅ—Hāṅre, etc.	Now (the same day) the lovely daughters of the god megh—Hāṅre.
Ae sāḷī Māṅitā dariyāo māṅ—Hāṅre, etc.	Went forth to the Māṅitā lake—Hāṅre.
Ae tape Jeth to Vesākhwāre balā to tapene—Hāṅre, etc.	The heat of Jeth and of Vaisākh beat fiercely on them—Hāṅre.
He tape Jeth to Vesākhre karme ⁶ lāgītārhe—Hāṅre, etc.	And from this heat of Jeth and Vaisakh great thirst assailed them—Hāṅre.
He Dāmar, ⁷ hawāho ⁸ Dāmorsere, Māṅitā dariyāo māṅ—Hāṅre.	These Dāmars, there were one hundred and twenty-five of them, went to Māṅitā lake.
He Dāmar sindāto pātliye ⁹ khelwā to lāgyā—Hāṅre, etc.	These Dāmars began to play pranks (with the daughters of Megh).
He phāḍe ghāghra lugdā ¹⁰ re Meghūnī sorinā—Hāṅre, etc.	They tore away the petticoats and Lugdas of the daughters of Megh—Hāṅre.
He paḍyā hāṅjunā haṅjolā re galati kera porna. ¹¹	(At last) dusk came and the waning light of evening fell.
Hāṅ bāi rowatīwo rajaltīwo ¹² hāmi wo hānjne	In the evening (home went) the girls bitterly weeping and ashamed—Hāṅre.
He Bāi kāṅi tūṅ karyosewo Māṅitā dariyāo māṅ—Hāṅre, etc.	"Oh daughters" (said their mother) "what did ye (so late) at Māṅitā tank"—Hāṅre.
Rāṅde ḍolā ¹³ nirūṅ lidāre—Hāṅre.	"Why, bad girls, do you bring (pots of) dirty water?"

¹ The meaning of the *te*: "Hāṅre, etc." is not clearly known to the singers. It will only be indicated after the first verse.

² Dhaya = dhala.

³ Sāṅḍini = Chāṅḍini.

⁴ = day.

⁵ = thin.

⁶ Karme = garme, here its affect, *i.e.*, thirst.

⁷ Both forms Dāmor and Dāmar occur.

⁸ Hawāho = Sawa sau used for "many".

⁹ Sindāto pātliye = a game like prisoners' lease.

¹⁰ Lugdā = Cloth covering head and shoulders.

¹¹ Porna = prahar, pahara, a watch of four hours.

¹² Rajaltī = lajjaltī (H. lajwanti).

¹³ Dola = dirty or muddy water.

SECTION C—*contd.*SPECIMENS OF BHIL SONGS—*contd.*No. I.—*The Song of a Kachumar Damar Bhil—contd.*

Aj, māḍī, ḍolā ne karyāse wo ḍolā ne nir ne	"To-day" (they replied) "oh mother, they made (all our) water dirty".
Puse kālurāna Megh ne—Hānre, etc.	Then kālurāna Megh (entering) asked them—Hānre.
Aj soriye pukāre saḍisewo mārā kālurāna Megh ne	Then the girls went and cried out, "oh dear kālurāna Megh".
Bāpā ijjat ābrū ḥidā—Hānre	"Oh father, they have destroyed our honour and virtue—" Hānre.
Aj Piyor ¹ saḍīkāne rihere mārā kālurāna Megh ne	Kālurāna Megh at this, Ah Friends, got very angry.
Saḍyā Meghūnā hānhuṇa ² —Hānre	(Then) began clouds to gather from all sides—Hānre.
Aj, Piyor, bola lone mārere mārā wāna se Meghḍā.	In his rage, Friends, he began to thunder from twelve hundred clouds.
Aj Meghḍā alopāwā lāgā Mara jodī na bālamne ³ —Hānre	Then the clouds began to fly away. Oh my good companions—Hānre.
Aj Piyor, ḍhundhūne ⁴ paḍyā sere ḍhundhū rūḍā kāl ne	Then, Friends, a fearful, terrible famine came upon them.
Paḍyā ḍhundhū rūḍā kāl ne—Hānre	(Yea) a devastating famine—Hānre.
Aj Ḍāmor hunānī galiye sere, māḍī honānī haveliye	Then did the golden (roofed) houses of the Ḍāmars melt away.
Ḍāmor anu ne dhanu gālya—Hānre	(Likewise) did their grain and riches vanish—Hānre.
Aj, Ḍāmor, ḍhundhūne paḍya sere ḍhundhū rūḍā kāl ne	(Thus) did a fearful, terrible famine fall on the Ḍāmars.
Ḍāmor garī ne gārḍ thāya—Hānre	The Ḍāmars are (thus) destroyed by evil plight—Hānre.
Ḍāmor pūswā ⁵ ne lāgi Mokal Ḍāmrānī	Then did Mokhal Ḍāmrānī question the Ḍāmars.
Pūse Hidmal Ḍāmarne—Hānre	She asked of Sidmal Ḍāmar (her husband)—Hānre.
Aj Ḍāmor bhūkūnā bhāgelāre, mārā Hidmal Ḍāmor ne	"In these days we are wasted by hunger, oh my Sidmal."
Kuriye Ḍhālka ⁶ paḍāiye—Hānre	"Make preparations to leave Ḍholka—" Hānre.
Aj, Piyor sālyākānī sālyāre mārā Ḍāmar na hangḍā	Then, Friends, the band of Ḍāmars set forth and started on their way.
Ḍāmor lelāgrā ⁷ mārgre—Hānre	The Ḍāmars (took) a wild forest road—Hānre.
Ḍāmor gagan uḍe khehane ⁸ —Mārā, etc.	The dust (raised by the band) rose up into the sky—Mārā, etc.
Ḍāmor kāmaṭhiyā ne take—Hānre	The (weary) Ḍāmars leant upon their bows—Hānre.
Aj Ḍāmor bhūkūnī bhāblati ⁹ re mārā Hidmal Ḍāmor ne	All the Ḍāmars were hungry (even) Sidmal Ḍāmar was faint.
Ḍāmor kadeli ¹⁰ dungre—Hānre	The Ḍāmars (at last reached) the kadeli hill—Hānre.
Aj, Piyor, aḍā ne phūryā sere mārā Nālūnā Narhingḍā	Then Friends, Nārsingh, son of Nālu, encountered them.
Māmā anū ne tolū dhanū—Hānre	(He Said) "oh uncle, I will weigh you out grain and riches"—Hānre.
Aj, Piyor, tākḍiye mānde sere mārā Nātūnā Narhingḍā	Then, Friends, Nārsingh, son of Nālu, set up his scales.
Aolya anū ne dhanū—Hānre	And weighed out (to them) grain and wealth—Hānre.
Mokhla bhojanīyā baṇāwe—Mārā ¹¹ , etc.	Then Mokhla prepared some food for them—Mārā.
Aj Piyor, jame kānī jamere mārā Hidmal Ḍāmor.	All, Friends, then were collected (for dinner) by Sidmal Ḍāmar.
Sālya Ḍāmor nā hangḍā—Hānre	Then (after dinner) the band started off—Hānre.
Aj Ḍāmor lūnbyā ¹² kānī lūnbyā ne mārā Godariyā serū ¹³ mān.	Then at length the Ḍāmors reached the town of Godhra.
Ḍāmor Pānīmiya ¹⁴ talāwu mān—Hānre.	They came to the Pānīmiya lake—Hānre.
Awyā oḍwāla-godwāla ¹⁵ —Mārā, etc.	They reached (the village) of Odwāla-godwāla Mārā, etc.
Ḍāmor Chanotīnā ¹⁶ rājū—Hānre.	(Then) the Ḍāmors came to the district of Chanoti—Hānre.
Aj Ḍāmor lūnbyā kānī lūnbyā ne mārā Dūdiyā ¹⁷ serū mān	Thus (at length) the Ḍāmors reached the city of Dudiya.
Ḍāmor Welji ¹⁸ kerī bāwe—Hānre.	The Ḍāmors (reached) Welji's well—Hānre.
Aj Ḍāmor lūnbiyu lūnbiyu, mārā Hidmal Ḍāmor ne	There arrived thus Hidmal Ḍāmor (at last).
Ḍāmor Sābānā ¹⁹ Sarowar mān—Hānre	So the Ḍāmors came to the lake of Sabana—Hānre.
Aj Ḍāmor Sāle kānī Sāle re—Mārā, etc.	So the Ḍāmors went ever on their way—Mārā.
Ḍāmor Dewad ²⁰ nā rājū—Hānre	The Ḍāmors came to the district of Dohad—Hānre.
Aj Ḍāmor lūnbyā kānī lūnbyu re mārā Hidmal Ḍāmor ne	Thus did my Sidmal arrive there.
Ḍāmor Tānḍā ²¹ ne taṇḍūle—Hānre	So the Ḍāmors came to a Banjāra encampment—Hānre.
Ḍāmar āyā kānī āyāre mārā Raṅbhāpur ²² nā rājū	Thus came the Ḍāmors to the district of Raṅbhāpur.

¹ Aj Piyor: the word Piyor is addressed to the audience.² (?) Hānhuna=Chahu (nā)=from all sides.³ Balamne=Lit. oh my equal (jodi) friends.⁴ Ḍhundhune=terrifying; ruda=good, much, very, great, etc.⁵ Ne=belongs to Ḍāmar.⁶ Ḍholka, in Gujarat. Padai=to pack up.⁷ Lelagra: rough, difficult, jungly.⁸ Khehane: dust.⁹ Bhāblati: lit. giddy, head-turning round.¹⁰ In Gujarat.¹¹ The alternative tek.¹² Lūnbiya: go to reach.¹³ Seru=Shahar, Godhra lies in the Bombay Presidency [22° 48' N., 73° 51' E.] to the west of Jhābua.¹⁴ Pānīmiya: 22° 50' N., 74° 0' E.¹⁵ Odwāla-godwāla: a village (?).¹⁶ Chanotina: Village (?).¹⁷ Dudiya: village (?).¹⁸ Welji: man or place (?).¹⁹ Sabana: village (?).²⁰ Dewad: Dohad [22° 50' N., 76° 19' E.].²¹ Tānḍā: 22° 53' N., 74° 30' E., or else a banjāra camp which is its meaning. Cf. Man. tānḍā, a band or company of people.²² Raṅbhāpur: 22° 55' N., 74° 33' E., in Jhābua State.

SECTION C—*contd.*SPECIMENS OF BHIL SONGS—*contd.*No. I.—*The Song of a Kachumar Damar Bhil—contd.*

Dāmor Māchhalyā ¹ kerī nāl mān—Hānre	Then the Dāmors came to the pass of Machhalya—Hānre.
Aj Dāmor lūnbyo kāni lūnbyo re mārā Hīdmal Dāmor ne Dāmor ghāntā ne ghatuliye—Hānre	So the Dāmors and my Sidmal at last arrived. The Dāmors came at length to the passes—Hānre.
Aj Piyor, lūnbyo kāni lūnbyo re mārā Dāmor nā hāngḍā Wālo, Rājgaḍnā rāj mān—Hānre	Then, Friends, the Dāmor band arrived here. Friends (they came) to the Kingdom of Rājgarh—Hānre.
Aj, Piyor, āwe kānī āwe re—Mārā, etc.	So, Friends, they arrived at length—Hānre.
Utre Mayiyārī ne āre—Hānre	(And) crossed to the (other) bank of the Mahi (river)—Hānre.
Aj Dāmar ayo kāni āyore mārā kulkīyā ² rāj mān	Then came the Dāmors to the district of—Kulkiya.
Wālo, Hagwāl ³ kera rāj mān—Hānre	(Then) Friends, to the district of Sagwāl—Hānre.
Aj Piyor, lūnbyo lūnbiyore mārā Hīlor ⁴ nā rāj mān	So Friends, they reached at last the district of Silor.
Aj Dāmor kul rangī Dhārū ⁵ mān—Hānre	Next (came) the Dāmors to lovely Dhār—Hānre.
Awe kāmathiyā ne ṭeke mārā Hīdmal Dāmar ne	Came my Hīdmal Dāmor (weary) leaning on his bow.
Dekhe Rājā to Bhoja ne—Hānre	Rājā Bhoja saw him coming—Hānre.
“Aj Dudā hāmla no tūn ri—jere ⁶ mārā, Dudātūn vajir ne”	“Listen” (said Bhoja) “oh Duda, to my words, listen, oh Duda, vajir.”
Awāyā Dāmor nā hangḍā—Hānre	(Behold) a band of Dāmors has come—Hānre.
Hānre Dudā kādyu kāni kādyure mārā kāluḍā ghoḍo nā Dūdo ghoḍilo bhīḍe re—Hānre	So Duda took out the (well-known) black horse. Duda saddled up his mare—Hānre.
Aj Dūdo hāt mān lido sere mārā Gāngajal bhālā ne Dūdo ghoḍilā chalāḍe—Hānre	Then did Duda take his spear “Gāngajal” in hand. Duda spurred on his mare—Hānre.
Aj Piyor thobyā kāni thobyāre mārā Dāmornā hangḍā	So, Friends, Duda stopped and halted the band of Dāmors—Hānre.
Dūdo pūsna to pūsne—Hānre	Duda questioned them—Hānre.
Aj Piyor bolyā kāni bolyāne mārā hawāho Dāmor ne	Then, Friends, answered the one hundred and twenty-five Dāmors.
Awya menat majūriye—Hānre	“With sore trouble have we come (seeking) work.”
Aj Dāmor ane ne tolūse ane ne dhanū ne	(Duda said) “I will (give) you grain and wealth weighing it out.”
Waho ⁷ khelanji khedā mān—Hānre	“Do you settle in Khelanji village”—Hānre.
Hānre Dūdo agāḍī hoyo sere—Mārā, etc.	So Dudo went on in front (of them).
Batāḍe hīma to heḍā ⁸ ne—Hānre	He pointed out to them the boundaries (of the village) and the limits (of the fields).
Aj Dāmor khūsī bhālo huwo—Mārā.	Then were the Dāmors happy and contented—Mārā, etc.
Bānde jarnā jhūpdā—Hānre	They built huts of bushes—Hānre.
Hānre Dūdo āle kānī āle re māre anū ne dhanū ne Mangalji anū tole dhanū—Hānre	They did Duda give them seed and money. Mangalji (Seth) weighed out this grain and coin—Hānre.
Aj Dāmor biyū bhālā lāwere mārā Hīdmal Dāmor ne	Then the Dāmors and Sidmal Dāmor too planted the good seed.
Barasyā kālurānā megh ne—Hānre	And kālurāna Megh sent rain—Hānre.
Aj Dāmor khāya khūshī kare—Mārā	And so the Dāmors ate and were content—Mārā.
Nīnde Mokhal Dāmrañī—Hānre	And Mokhal Dāmrañī weeded (the field)—Hānre.
Aj wālra pākī bhālā gayā mārā Hīdmal Dāmor nā Wālra wāḍwā lāgā ne—Hānre	At length excellent wālra ripened, for Sidmal Dāmor. He began to cut the Wālra—Hānre.
Aj Piyor, joḍī nā bolyā sere mārā hawāho Dāmor ne	Then, Friends, the crowd of Dāmors, spoke among themselves.
Dāmor dāna bhālā walyā—Hānre	“(So) a good day has come for the Dāmors”—Hānre.
Seth bharwā bhālā āyā—Mārā, etc.	The Seth came and removed the food (grain).
Dāmor dhānu ne bharāwe—Hānre	The Dāmors gave him over the grain—Hānre.
Aj Seth bharī ne gher gyāre—Mārā	So loading up (the grain) the Seth went home.
Jāya chhe jhājūñī kamāi ⁹ —Hānre	He went away to trade in ships—Hānre.
Aj Dāmor Sokī kare pūlare—Mārā	Then the Dāmors kept and stored the rest—Mārā.
Mangalji bāre barsa—Hānre	For twelve (long years) was Mangalji away—Hānre.
Aj māri Virmāke bāi sere Virmā bañiyāñī	So (he left behind his wife) the lady Virma, Virma, the baniya's wife.
Rāṇḍu na tariyā ¹⁰ to joban jāyase—Hānre	The woman's youth was thus passing away like a widow.
Virmā kānkhūmā sabde sere mārā Hīdmal Dāmar ne	Virma (at length yielding) went and lived with Hīdmal Dāmor (as his wife).
Rāṇḍ ne maīnā ne rayā—Hānre	The woman became with child—Hānre.
Rāṇḍ ne navamo maino jāyase—Mari	So her nine months were fulfilled—Mārā, etc.
Awī Hījū tūn hajwān—Hānre	Came Hiju, the midwife—Hānre.
Aj Hījū peṭ ḍalā sole ¹¹ sere—Mārā	Then she rubbed and massaged (Virma's) stomach.
Janmyā rājliyā bālūḍā—Hānre	And (two) princely sons were born—Hānre.
Aj kuṅwar ḍhola mān ḍhavale sere—Mārā, etc.	Then the princes were swung in a crib—Mārā.
Kuṅwar mālūna moṭiyar—Hānre	(In time) they grew big enough to walk—Hānre.
Aj Mangalji gherule ālyose—Mārā	At last Mangalji came home again—Mārā.
Bole nagari kerā logne—Hānre	The City and Village folk (at once) cried to him—Hānre.
Aj Mangalji kuṅwar do huwāse—Mārā	“Oh Mangalji, (know you) that you have two sons.”
Aj pūse dhañi dhañiyāñī ne—Hānre	Then did the husband question the wife—Hānre.

¹ Machhalya : a pass in Jhabua State (22° 45' N., 75° 50' E.).² Kulkiya (?), a village.³ Hagwal=Sagwal (22° 38' N., 75° 1' E.).⁴ Hīlor=Silor (chiler of maps, 22° 3' N., 75° 15' E.).⁵ Dhar (22° 36' N., 75° 19' E.), Capital of Dhār State.⁶ Ri-jere=Rahna.⁷ Watso=Waso, i.e., baso.⁸ i.e., Sīma, Sheda=edge, limit.⁹ Kamai=Beipāri.¹⁰ Tariyā=woman.¹¹ Sole=chole from cholana, to rule hard.

SECTION C—*contd.*SPECIMENS OF BHIL SONGS—*contd.*No. 1.—*The Song of a Kachumar Damar Bhil—contd.*

Aj Piyor laḍkā kākūnā huwā sere māri lāduni dhanīyāni	" Beloved, dear wife, of whom are these boys ?"
Laḍkā motānā hoyāse—Hānre	" They are (she said) the sons of a great man"—Hānre.
Aj Mangalji doḍyo dhāmyo jāyase—Mārā	Then Mangalji running and speeding went off—Mārā.
Sadi gyo Dhārni kaseḍiyān—Hānre	He went to the law court in Dhār (City)—Hānre.
Aj Piyor, pokāre baṇāwe sere Mangalji baṇyo	Then, Friends, Mangalji the bania called aloud for justice.
Padyā Mangalji na ijjatdā—Hānre	" The honor of Mangalji is gone"—Hānre.
Aj dhaṇi bole kāni bolere māro gelo Rājā Bhoja to	Then (hearing him) the master, great king Bhoja, spoke.
Karo nagārno ¹ danko—Hānre	" (Duda) sound the kettle-drums"—Hānre.
Aj Dūdo saḍyo kāni Saḍyore—Mārā	Then Duda arose and marched forth.
Gheryo Dāmora nā hāngdā—Hānre	So (Duda) surrounded the Damar band—Hānre.
Dāmora Hidmal laḍesc—Mārā	And Sidmal met him in the field—Mārā.
Dāmora ādā māri nākhyā—Hānre	So half the Dāmors were slain—Hānre.
Dāmora mor bāndhiyāne bāndhiyā—Mārā	The hands (of the other half) he bound behind their backs.
Bhāgyā khelanji kheda ne—Hānre	And destroyed khelanji Village—Hānre.
Aj Dūdo gāyūn kāni gyūnre māro Dūdo vajir ne	Then did Duda, Duda the wazir, start and go (home).
Gyo Dhār ne darwāje—Hānre	So came to the gates of Dhār—Hānre.
Dāmora māri ne gārd karyā re—Mārā	(He cried) " I have slain and uprooted the Dāmors"—Mārā.
Dūdo kāḍiyā bolāwo—Hānre	" Call (said Bhoja) masons here"—Hānre.
Aj, Piyor, āwyā kāni āwyā re mārā hawāho kāḍiyā	Then there came, came (from all sides) one hundred and twenty-five masons.
Dāmora jiwata rūda saṇyā ² —Hānre	The Dāmors were bricked up securely—Hānre.
Aj Dāmora saṇi kāni didāre Bawriyā kotūmān	So the Dāmors were (walled up) in the fort of Bawriyā.
Mangalji khushi bhalo huwo—Hānre	And Mangalji rejoiced exceedingly—Hānre.
Aj Virmā doḍi dhāmi sālire, māri Virmā baṇiyāni	And Virmā, our Virmā, the bania's wife, went away running, and hastening.
Jāyase bhāiyānā gherū mān—Hānre	Went off to her brother's house—Hānre.
Aj Piyor, kasūmar, ³ khoklio mārā joḍina laḍkāne	Friends, kachumar and khoklia, were the name of the two boys.
Kasūmar Vidhya bawnāwa sāliyo—Hānre	So kachumar went off to gain learning (or magic)—Hānre.
Aj, Piyor, doḍyo dhāmyo jāyase re māre kamrū dharti mān	So hastening and hurrying, Friends, he went to the land of kamru.
Utre kshiprā nadi—Hānre	He crossed the kshiprā river—Hānre.
Aj dhaṇi gayo kāni gayo ne mārā Ratna nā ghoral mān	So the Lord (Kachumar) went (and dwelt) at the house of Ratna.
Kasūmar Vidhyā bhaṇāwā lāgo—Hānre	And kachumar commenced to learn magic—Hānre.
Aj dhaṇi bhaṇi kāni gayo sere bāre kāni vidhyā	Then Lord (kachumar) learnt the twelve (kinds of) magic.
Ratna ghāni mān kheḍe—Hānre	Ratna (by a spell, however) yoked him to an oil mill (as an ox).
Aj dhaṇi gher jāwānā mansūbā kare—Mārā	Then the Lord (kachumar) longed to return home.
Ratna saḍigi Indrāhaṇ mān—Hānre	Ratna (one day) went to Indra's heaven—Hānre.
Aj kasūmar nāhawāne lāgo—Mārā	Upon this Kachumar fled away—Hānre.
Lidi Vidhyāni kothali—Hānre	And took with him the bag of magic (books and simples).

[Here the metre undergoes a change.]

Kasūmar Sāli bhalo nikalyo—Re Dehariyā (Tek)	And kachumar went off and got well away—Re Dehariyā (Refrain).
Dewa māro Dhār mān āyose—Re Dehariyā	So the god came to Dhār.
Ayo Indrāiyā bāgū mān—Re, etc.	Came to the garden of Indra—Re., etc.
Baṇi gyo jayadhāri jogḍo—Re.	Disguised himself as a Jatā-bearing Jogi.
Dewa māro dhūpiye dhakāwe—Re.	The god lighted a sacred fire—Re.
Dhaṇi māro ādi rāt ne samiye—Re.	The Lord at the midnight hour—Re.
Sole ang rūḍā mole—Re.	After well rubbing and massaging his body—Re.
Baṇayo Batwo ūndaro—Re.	Made (from his sweat) a rat, Batwa by name—Re.
Baṇāwi Himāli nāgan—Re.	Made (too) a female snake Himāli—Re.
Ūndaro bhaṇāwi ledosi—Re.	He took the rat and instructed him—Re.
Melyā Bādaliyā mela mān—Re.	Sent them to the Bādaliya palace—Re.
Ūndaro khāt ⁴ rūḍo pāde—Re.	The rat bored a deep hole—Re.
Pāsāl Himāli nāgan—Re.	Behind him (followed) Himāli, the snake—Re.
Nāgan palang dholama—Re.	The snake wandered round the bed—Re.
Kuti ⁵ Himāl Kuṇwari—Re.	(On which) slept the princess Himāl—Re.
Nāgan Sontle ⁶ saḍwā lāgi—Re.	The Snake began to climb up by the braid of her hair—Re.
Dasī ṭasi tūn āngliye—Re.	And (then) bit her on the little finger—Re.
Pelān ⁷ nākhūn saḍyā bakhū ⁸ —Re.	(The) poison went in at her nail—Re.
Paḍi nagari mān būmase—Re.	Lamentation sounded throughout the city—Re.
Awyā nagri, kerā log—Re.	Together came all the folk of city and village—Re.
Bediyā ⁹ bolāwi lidāse—Re.	They summoned and brought all the doctors—Re.

¹ Nagārno = nakāra.² Saṇyā = H. chunaya, i.e., arranged; built up.³ Kasūmar, a local god, apparently a deified Bhil of the Kundwala sept.⁴ Khāt = kat.⁵ Huti = Soti.⁶ Sontle = Chonti. There is a superstition that no snake can climb up a bedstead, hence but for the braid of hair hanging down the princess would have been safe.⁷ Pelān = her (nail).⁸ Bakhū = Vish.⁹ Bediyā = Vaidya.

SECTION C—contd.

SPECIMENS OF BHIL SONGS—contd.

No. I.—The Song of a Kachumar Damar Bhil—contd.

Bole gelo Rājā Bhoja—Re.	Then Spoke beloved Rājā Bhoja—Re.
Kuṅwāri dharmen ¹ ne paraṅwā ūn—Re.	" I swear to marry (her curer) to the princess."
Bakḍo nahin ne wālyo ² wālyo—Re.	(They) could not stop the poison by spells—Re.
Dokḍi Indrāri bāgū mān—Re.	An old beldame (went) to the Indrari garden—Re.
Pūse kasūmar kundwāla—Re.	Asked kachumar-kundwala of her—Re.
Dokri sāni paḍi būm—Re.	" Old woman, what noise is that ?"
Mari Himāle kuṅwarī—Re.	" Princess Himāli is dead " (she said)—Re.
Dokri hānmal ³ māri bāt—Re.	(He said) " Beldame mark well my words"—Re.
Jāje gelo Rājā Bhoja—Re.	" Go, pray, to Rājā Bhoja"—Re.
Awaje wanā to wastre—Re.	(And say) come (before me) unclad."
Awaje anwāne pagū—Re.	" Come with unshod feet"—Re.
Lāwajo Dūdo Wajirne—Re.	" Bring also Duda Wazir (with you)"—Re.
Lāwajo huṅā tūn pālkhi—Re.	" Bring also the golden Pālkhi"—Re.

(SPOKEN PROSE).

Hamū hukkā piye tukā piye, hagiye, mūtriye tino mān gumān rākhenī. Terā hāmarā sāle maṅtra jantra.	I will smoke, etc., before him as if (in my own home) in privacy, so will my charms be efficacious.
Awe gelo Rājā Bhoja—Re.	Then came noble Rājā Bhoja—Re.
Awe huṅāni pālkhi—Re.	Came also the golden pālkhi—Re.
Kasūmar kūdi rūḍo betho—Re.	Kachumar Sprang lightly into it and sat there—Re.
Awe Bādliya melā mān—Re.	(They) came to the Bādaliya palace—Re.
Maṅtra bhaṅawā lāgyo—Re.	He began to recite incantations—Re.
Nāgaṅ koṭū ne kāngre ⁴ —Re.	The snake was (lying) on the fort's battlements—Re.
Nāgaṅ mangāḍi ledi—Re.	He (thus) summoned the snake—Re.
Nāgaṅ Soṭāḍi dedī—Re.	He put the snake's mouth to the wound—Re.
Bakḍo Sūhi ⁵ kānī lidā—Re.	(The snake) sucked out the poison—Re.
Himal beṭhi ruḍi huwī—Re.	Himali sat up cured—Re.
Khushi hoyo gehelo Rājā Bhoja—Re.	Pleased was noble Rājā Bhoja—Re.
Khushi huwī Bijārā rān—Re.	Overjoyed was Bijārā Rān—Re.
Kare lila pilā bāns ⁶ —Re.	Preparations for the marriage were made—Re.
Māngāḍyā korāre kalaha—Re.	Sent for new water-pots—Re.
Kasūmar pyaṅetūn ⁷ baṅawē—Re.	So kachūmar carried out his wedding.
Dewā māro phera rūḍa phere—Re.	The god circumambulated (the fire) as was fitting—Re.
Baṅi gya dhaṅi ne dhaṅiyāṅi—Re.	So became they man and wife—Re.
Bole Dūdo to wajir ne—Re.	Then spake Dūda wazir—Re.
Hāmāl gehelo Rājā Bhoja ne—Re.	" Hear, oh Rājā Bhoja, the good"—Re.
Hunpo ⁸ Hunago bachhero—Re.	" Make over to him the colt Sunaga."
Hāmro ⁹ lādūna ¹⁰ hāharā ¹¹ —Re.	(Kachūmar said) " Hear, dear father-in-law"—Re.
Lāwo Indariyā palān—Re.	" Bring the Indariya Saddle"—Re.
Lāwo honāni laḡāmo—Re.	" Bring the golden bride"—Re.
Kasūmar bhonyarā ¹² mān utre—Re.	Down to the stable went kachūmar—Re.
Kāḍyo Honago bachhero—Re.	Brought out the colt Sunaga—Re.
Ghoḍo bhīḍi bhālo ledo—Re.	Saddled up securely his mount—Re.
Ini ādi rāt ne same—Re.	It was then the hour of midnight—Re.
Bhūmi aswār bhālo huwo—Re.	Clear from the ground he sprang into the saddle—Re.
Ghoḍo Bādliya melā mān—Re.	Brought the horse up to the Bādliya palace—Re.
Kuṅwarī ne bolāwī lidise—Re.	Called the princess, and took her (up)—Re.
Lūnbyo ghoḍi tūn darwāje—Re.	So the mare reached the (city) gate—Re.
Poliyā pol ne ugāḍje ne—Re.	Kachūmar cried " Doorkeeper, open the gate."
Huṅ se gehelo Rājā Bhoja ne—Re.	" I am the beloved Rājā Bhoja"—Re.
Pole ugāḍi didi—Re.	(The gatekeeper) threw open the doors—Re.
Poliyā lānbo hāt karo—Re.	" Hold out your hand, gatekeeper " (he cried)—Re.
Jane aelāmo ¹³ alūsu—Re.	" I will give you a reward"—Re.
Hāth wāḍi bhālo lido—Re.	Then kachūmar cut his hand clean off—Re.
Ki je Rājā rūḍā Bhoja ne—Re.	" Go, tell (he cried) that noble Rājā Bhoja—Re.
Wāliy ¹⁴ bāpindā beruse—Re.	" I am revenged on my father's enemy"—Re.
Ghoḍo bābre—dāda no—Re.	" (I have recovered) my grand father's horse"—Re.
Kuṅwarī beru mān pyanyo ¹⁵ se—Re.	" In revenge have I married the princess"—Re.
Ghoḍo uḍāmā māre se—Re.	His horse bounded (into the air)—Re.
Ghoḍo Maiyāri ne āri se—Re.	At length (he and) his steed reached the Mahi's bank.
Lūnbigō Gaje kuṅwar ¹⁶ —Re.	Came to (the hill) of Gaje kuṅwar—Re.
Ayo kānkara Bharāḍi—Re.	Came to (the Shrine) of kankara Bharadi.
Lūnbiyo Patlāwad ¹⁷ nā rājūna—Re.	Came to the district of Petlawad.—Re.
Lūnbiyo khawāsānā ¹⁸ rājū—Re.	Came to the district of khawasana—Re.

¹ Dharmen= by my religion, i.e., I swear, or else may mean " free of (bride-price)". But the former meaning is best here.

² Wālyo=H. Warna, to avert, Ward off.

³ Hānmal=Sambhāl, i.e., attend to, mark.

⁴ Kāngre=(?) P. kangarah or H. Kandar.

⁵ Sūhi=Chusi.

⁶ Kare, etc., idiomatic expression for a hasty wedding in which coloured bamboos are used for the Mandapa.

⁷ Pyaṅetun=Paraniyane.

⁸ Hunpo=Sonpo.

⁹ Hāmro=hamlo=sambhal, attend to, mark.

¹⁰ Lāduna=Lād-una. H. tād.

¹¹ Hāhara=Susra.

¹² Bhonyarā lit "ground rooms" the stables were under the dwelling rooms.

¹³ Aelāmo=inām, a corruption.

¹⁴ Wāliya=badla.

¹⁵ Pyanyo=biyah.

¹⁶ Gaje kuṅwar is a hill near Umarkot (22° 47' N., 75° 53' E.).

¹⁷ Petlāwad in Indore State (23° 1' N., 74° 50' E.)

¹⁸ Khawāsā in Jhabua (23° 7' N., 74° 45' E.).

SECTION C—*contd.*SPECIMENS OF BHIL SONGS—*contd.*No. I.—*The Song of a Kachumar Damar Bhil—concl'd.*

Lunbiyo Sarwato pātan—Re.	Came to the City of Sarwa.
Lunbiyo Lilāgar ¹ dūngre—Re.	Came to the hill of Lilagar—Re.
Kasūmar dūngre Saḍi gayo—Re.	Climbed on to the top of Kachūmar's hill—Re.
Dūngar khoḥi bhālo lido—Re.	And at once removed (from it) Sandiya and Gandiya,
Māra Saṇḍiyā Gaṇḍiyā, bhūt—Re.	demons—Re.
Bādh bhari phenyā—Re.	Took them in his arms (and) hurled them forth—Re.
Paḍya dūngarani bhintū mān—Re.	So they fell from summit to base—Re.
Khājo piyo mojā mārjo—Re. Dehariyā	Eat, drink, be merry and rejoice—Re. Dehariyā.

No. II.—*Song of Manota Bhil.*

Manota here sung of is also a Bhil deity. There is good reason to suppose that he was originally a chief of note in Baria, a State lying on the south-west border of Mālwa in the Bombay Presidency.

Mūliyo to māli se—Re. Dehariyā	There was once a gardener Mūli—Re. Dehariyā.
Māri Mūli to Mālan se—Re.	There was (also) his wife Mūli—Re.
Inī Dewad do baṇiye—Re.	They (dwelt) in Dohad of two borders—Re.
Kare bāḍi to gowāḍi—Re.	They laid out a fine orchard.
Thāne lila pira ānbā—Re.	They planted various kinds of mango—Re.
Ānbā mālana motiyār ne—Re.	The young mangoes grew up—Re.
Sope ² marwā to mogrā—Re.	Planted Marwa and Mogra shrubs—Re.
Sope dādam ne dākhe—Re.	Planted pomegranates and vines—Re.
Sope khele to khajūr—Re.	Planted plantains and date-palms—Re.
Sope sanpo ne sameli—Re.	Planted Champa and Chameli—Re.
Māra hākriyā ³ ānbā—Re.	Put in sweet mangoes—Re.
Dāde ⁴ nareliyā ānbā—Re.	Planted cocoonut-like mangoes—Re.
Baṇāwe bāg ne baḡichā—Re.	So was planted the garden and the orchard—Re.
Phūlyā marwa mogra—Re.	Then flowered the Marwa and Mogra—Re.
Phūle dādam ne dākha—Re.	Flowered the pomegranates and vines—Re.
Phūle kela to khajūr—Re.	Flowered the plantains and date-palms—Re.
Phūle sanpo ne sanpeli—Re.	Flowered the Champa and Chameli—Re.
Ānbe phūlbhala lāgā—Re.	Fruit in plenty bore the mangoes—Re.
Lāgā hindūriyā ānbā—Re.	Minium coloured mangoes hung on the trees—Re.
Mūliyo khāya ne mojā kere—Re.	Mūl eat (of the fruit) and rejoiced—Re.
Mūlan khāya ne majā kare—Re.	Muliya eat (also) and was glad—Re.
Māra Majūto Bāriyā—Re.	There lived a Bariya Bhil (called) Majuta—Re.
Tenā kalkaltā kuṇwar—Re.	He had a quarrelsome son—Re.
Baḍo balawati dewa—Re.	He was a powerful lord—Re.
Baḍo rihūno janjālū—Re.	He was of hot and violent temper—Re.
Māro Manotā kuṇwar—Re.	Was this prince, Manota (by name)?—Re.
Dewa māro Bārāni dharti mān—Re.	My lord lived in the land of Bāra—Re.
Dewa māro āwā bhālo lāgo—Re.	My lord set gaily forth (on a journey)—Re.
Awe Bāriyā no hangḍo—Re.	There came a band of Baria (Bhils).
Hāthe maṇotā kuṇwar—Re.	(Came) with prince Manota—Re.
Awe Dewad do baḍiyā—Re.	They came to Dohad of two boundaries—Re.
Awe Maṇotā Kuṇwar—Re.	So lord Manota arrived there—Re.
Awe Mūliyāni bāḍiye—Re.	Came to the garden of Mūli—Re.
Nakhe ⁵ bhamera palitā—Re.	Threw down the upper wheel and lower roller (of the well)—Re.
Sabdyā ūṇḍe khādo dāḍya—Re.	Removed and sank them deep in the pit—Re.
Dewa māro manūnā mansūbā—Re.	My Lord then thought the matter out—Re.
Pūse Mūliyā māli ne—Re.	He questioned the gardener Mūli—Re.
Mūliyā wāḍi kuniyo se—Re.	"Mūli, whose garden is this?"—Re.
Wāḍi bāpre dādā ni—Re.	(He said) "It was my father's and grandfather's"—Re.
Dewa māro bolwā lāgo se—Re.	"Then my Lord began to speak—Re.
Wāḍi tāri kānṭhi āwi—Re.	"How came (said he) this garden to be thine?"—Re.
Wāḍi māra Bāpdāda ni—Re.	"It was my grandfather's" (said he)—Re.
Dewa māro laḍā kāne lese—Re.	Then my lord began to wrangle—Re.
Jāyāse Dehāi ne kaseḍiye—Re.	He went off to the Desai's court—Re.
Desai bolwā rūḍo lāgo—Re.	The Desai began to question fully—Re.
Mūlyā kim rūḍo āwyo—Re.	"Mūle, why have you come here?"—Re.
Māro Manoto Kuṇwar—Re.	(He replied) "My (lord) Manota"—Re.
Lese wāḍi ne gowāḍi—Re.	"Wrests my garden and orchard (from me)"—Re.
Wāḍi bāpne dādāni—Re.	"The garden that was my grandfather's"—Re.
Bole Manoto kuṇwar—Re.	Then spoke Lord Manota—Re.
Hāmal Dewad nā Dehāi—Re.	"Hear, oh Desai, of Dohad"—Re.
Kāḍe bhāmyo palitā—Re.	"He who fishes out the Bhamera and Palita"—Re.
Wāḍi teni se—Re.	"To him shall be the garden"—Re.
Ayo Dewada no Dehāido—Re.	Then came the Dohad Desai—Re.
Ayo Mūliyā ni wāḍiye—Re.	Came to the garden of Mūli—Re.
Bole Dewad no Dehāido—Re.	Then spake the Desai of Dohad—Re.
Kūḍ Mūliyā tū māli—Re.	"Do thou Mūli gardener spring (into the well)"—Re.
Kāḍo bhāmyo ne palitā—Re.	"And get up the Bhamera and Palita"—Re.
Paritāni ne bhālā nikalyā—Re.	(But) he failed to get up the Palitā—Re.

¹ A hill in Khusālgarh State, Rājputāna.

² Sope = Ropna, to plant.

³ Hākriyā = Sākriya, sugary.

⁴ Dāde = (?) gāde.

⁵ Nakhe, to throw down; bury. Bhamera, the upper pulley in the thala of a well, Palita, the lower roller. The ropes for the Charsa pass over these.

SECTION C—*contd.*SPECIMENS OF BHIL SONGS—*contd.*No. II.—*Song of Manota Bhil—contd.*

Kūde Manoto Kuṅwarre—Re.	In sprang Lord Manota—Re.
Kāḍya bhamera palitā—Re.	Brought out the Bhamera and Palitā—Re.
Wāḍī khohī rūḍī ledī—Re.	He (then) destroyed the garden completely (from Mūli) —Re.
Manota khūsī bhalo huyo—Re.	Overjoyed was Manota—Re.
Dehāido nyāwa rūḍo kere—Re.	“Oh Desai, (he cried) indeed you gave justice”—Re.
Manote wāḍī bhāgi nākhi—Re.	Manota then utterly destroyed the garden—Re.
Giyo se Lilāgar dungre—Re.	(Then) he went off to Lilāgar hill—Re.
Dewa māro ghorī ¹ en ghorī huwe—Re.	Here (he found) Lord (Kachūmar) snoring loudly—Re.
Mayade ² pogūno angotho—Re.	He twisted the big toe of his foot—Re.
Uṭhyo Dāmar kasūmar—Re.	Up sprang kachūmar Dāmar—Re.
Bhāneja kem āwū paḍyū—Re.	(And cried) “oh son of my sister, why camest thou hither?”—Re.
Hun to biyū lewā āyo—Re.	“I have come to get seed from you”—Re.
Rolyo kayḍo ³ kasūmar—Re.	Then answered kachūmar roughly—Re.
Alūn hindūriā tūn nāreliyā—Re.	I will give you minium coloured cocconut—Re.
Alūn kela to khajūr ne—Re.	I will give you plantains and date-palms—Re.
Alūn marwā ne to mogrā—Re.	I will give you Marwa and Mogra—Re.
Alūn dāḍam kera biyūn—Re.	Seeds of pomegranates will I give—Re.
Alūn sanpeli nā biyūn—Re.	Seeds of Chameli will I give—Re.
Bijū Dhār nā rājā nā chhe—Re.	These seeds come from the Rājā of Dhār.
Manoto biyūn line re āwe—Re.	Manota took the seeds and returned—Re.
Lāgya rohāne mārge—Re.	Took the jungle path—Re.
Ayo Dewad do baṅye mān—Re.	Came to the boundaries of Dohad—Re.
Manota kyāra re bhalo bāṅde—Re.	Excellent beds did Manota prepare—Re.
Mūliyo nokar re wā lāgo—Re.	Appointed mūli his servant—Re.
Nākhe hindūriyā āṅbe—Re.	He planted minium coloured mangoes—Re.
Khel khajūr ne to nākhe—Re.	Planted plantains and date-palms—Re.
Marwā mogrā to nākhe—Re.	Planted Marwa and Mogra—Re.
Dāḍam dākhe to nākhe—Re.	Planted pomegranates and vines—Re.
Sanpo sameli to nākhe—Re.	Planted Champa and Chameli—Re.
Wāḍī tyār to kī dī—Re.	So did he make his garden—Re.
Mūliyo pāṅi to sanche—Re.	And Muliyo watered it with water—Re.
Manota khāi ne khusal kere—Re.	Manota eat of (its fruit) and was pleased—Re.
Kasūmar kāgdiyā ne bheje—Re.	And kachūmar sent a letter—Re.
Kāgad Dharmū ne rājā mān—Re.	Sent a letter to the Rājā of Dhār—Re.
Dūdo kāgdiyā to wāse—Re.	Duda read the letter—Re.
Sadyo gelo rājā Bhoja ne—Re.	So Rājā Bhoja mounted—Re.
Sade geheli hāthanīyo—Re.	Mounted a fine female elephant—Re.
Sadyo Dūdo to wajūr ne—Re.	And Duda Wazir also mounted—Re.
Sadyā Mughaliyā Paṭhān—Re.	His Mughals and Pathāns also mounted—Re.
Wāge nagārā nī ghaiyā—Re.	The kettle-drums made a deafening noise—Re.
Sadyā phojū nā dhamkārā—Re.	The tramp of his army reached (sounded) far—Re.
Dabe lūnbiyu lūnbiyu āwe—Re.	The army marched and marched—Re.
Awyā Manoto ni wāḍiyā—Re.	Came to Manota's garden—Re.
Wāḍiyā bheli ⁴ bhali nākhi—Re.	Destroyed thoroughly that garden—Re.
Wāḍī bhāgi ne bhūkū Karyu—Re.	Completely broke up the garden—Re.
Dukhū bhāgi ne bhūkū wālyā ⁵ —Re.	So should your pains be removed—Re.
Manoto Bhawāni ne kanene ⁶ —Re.	Manota (went) and lived near (the shrine) of Bhawāni— Re.
Manoto gaḍino hāṅkwā—Re.	Here he had to drive a cart (for the goddess)—Re.
Mārā arthū āḍī gayū—Re.	My wheel stuck (in the mud)—Re.
Dewa gaḍī ne hāṅko—Re.	But the god drove on my cart—Re.
Manoto dhare ruḍo beṭhā—Re.	Manota came and sat on the pole—Re.
Manoto “ki kiyāri” re kare—Re.	He shouted “ki ki”—Re.
Gāḍiye haḍḍī ⁷ ne sāli—Re.	And the cart went on at once.—Re.
Bhāgyā duniyā kerā dukhū—Re.	So may the world's ills fly away—Re.
Dukhū bhāgi ne bhūkū kidā—Re.	Ills fly away and be destroyed—Re.
Khājo pijo mojo mārjo—Re. Dehariyā	Eat, drink, rejoice, and be merry—Re. Dehariyā.

No. III.—*The Lay of Narsingh Bhil.*

Aj ine ine range re rabalā devūn vedvūn, Ae deharā deharāno melāwo—Re. Dehariyā.	I bow to every deity and worship them in many tem- ples—Re.
Māro Nālu nā Narsingh—Re. Dehariyā	My Narsingh, Son of Nālu—Re. Dehariya.
Teḍe Halūno soriye—Re.	Asked Salun, to (join in) thieving—Re.
Halūn dham kāryo ne āwe—Re.	And Salun came hastening—Re.
Awyo Narsingh nā darwāje—Re.	Came to the door of Narsingh—Re.
Baṅi gyā mānmā ne bhānej—Re.	Joined them his uncle's and sister's sons—Re.
Sālo sorī ne karwā jāiye—Re.	So they went forth to commit theft—Re.
Nāring sakaniyā ne mānge—Re.	And Narsingh consulted Omens—Re.
Dābi kāgḍī bole se—Re.	On the left hand a crow croaked—Re.
Jamaṅi Rūpārel bole se—Re.	On the right a Ruparel called—Re.
Nāring sāli ne bhalā nikaliyā—Re.	So Narsingh (thus) assured started—Re.
Hāthe Hālūna soriye—Re.	With him (went) Salu to steal—Re.

¹ Ghorī=Mar : ghorne, to snore.² Mayad=H. Moda.³ Kaydo=Kadwa, bitter, rough, sharp.⁴ Bheli bhali=lit. good and well.⁵ Walya=Said to the audience.⁶ Kane=near.⁷ Haddi=Suddenly, all at once.

SECTION C—*contd.*SPECIMENS OF BHIL SONGS—*contd.*No. III.—*The Lay of Narsingh Bhil*—*contd.*

Nārhiṅg nā hangdo—Re.	“ The band of Narsingh ” [they answered]—Re.
Sāmuṅḍā hīḍā ¹ ne ālyā bādā—Re.	And Chāmunda brought supplies—Re.
Sāmuṅḍā satri ² to isārāṇa—Re.	Chāmunda [prepared] sixty-three dishes—Re.
Baṅyā batrī to bhojan—Re.	Made ready [another] thirty-two kinds of food—Re.
Nārhiṅg bhojan rūḍā jame—Re.	Narsingh eat all the dishes—Re.
Dhāle hīṅgālūao dholyo—Re.	A scarlet bedstead was set out—Re.
Bānthre reshmi godāḍa—Re.	[On it] was laid a silken quilt—Re.
Nārhiṅg hui ³ ne bhalā gayo—Re.	And on it Narsingh slept well—Re.
Sāmuṅḍā ne kākhūmā sabdyā sefc—Re.	Chāmunda consorted with him—Re.
Sāmuṅḍā nā jobaniyā lūtiyose—Re.	He robbed Chāmunda of her virginity—Re.
Tenā aodānū ⁴ banyā se—Re.	He caused her to become pregnant—Re.
Anyā kelū ne kera dhūmiyā ⁵ —Re.	He fetched a plantain stalk—Re.
Dhūmiā soḍū mān sūwādyā—Re.	Put the stem by her side—Re.
Nārhiṅg hangdo lī ne nātho—Re.	(Then) Narsingh taking his band fled—Re.
Sāwuṅḍā martārai parai kapḍā—Re.	Swiftly Chāmunda dressed—Re.
Ledi kastūri ghoḍiye—Re.	Brought out the mare kasturi—Re.
Hoḷgī bhūmi ne aswāre—Re.	Sprang from the ground into the saddle—Re.
Sāwuṅḍā āḍā rūḍā pūriyā—Re.	Stoutly placed herself across (their) road—Re.
Gheriyo Nārhiṅg no ha. gḍā—Re.	Confronted (lit : surrounded) Narsingh's (whole) band—Re.
Boli Raṅiyārī Sāmuṅḍā—Re.	(Then) spoke Chāmunda of Raniyala—Re.
Randwā hūṅ ne nāme pahū—Re.	“ Wretch, what name is (the child) to bear ? ”—Re.
Soro Virkhetliyo—Re.	“ If a son, (he answered) Virkhetliā ”—Re.
Sori Virālikhetli—Re.	“ If a girl, Virālikhetli—Re.
Sāmuṅḍā pāsā pharī āwo—Re.	(Then) Chāmunda turned back home—Re.
Sāmuṅḍā maino ne samāle ne—Re.	And so Chāmunda reckoned up the months—Re.
Maino aṭhmo nawamo sāle—Re.	And the eighth (and then) the ninth month came—Re.
Sāmuṅḍā ne peṭ mān dūkhe—Re.	Pains came in Chāmunda's womb—Re.
Bolāwe Hajaṇā hunwāni—Re.	Sajana, the midwife, was called—Re.
Mangāḍe kāsī ⁶ ghanī ⁷ nā telu—Re.	She obtained fresh oil from the mill—Re.
Meliyā unāṅ ṭhāḍā pāṅi—Re.	Mixed it with cool water—Re.
Hajū hēlye māre se—Re.	Saju rubbed (her womb)—Re.
Hoye rājaliyā bāludā—Re.	A princely boy was born—Re.
Baṅi gyā khetliyā kunwar—Re.	He was called prince khetliā—Re.
Devatā wāhūle badhe se—Re.	The God-like child grew—Re.
Māḍi bhogne bhalā ālo ne—Re.	(One day he said) “ Mother, make a good offering for me ”—Re.
Alyā kūkdā ne bokḍā—Re.	She brought a cock and a goat—Re.
Alyā korātūn khisḍā—Re.	Brought also fresh kichdi—Re.
Alyā narelū sūrmā—Re.	Brought cocoanuts and surma—Re.
Alyo bāre bhātī no haro ⁸ —Re.	Brought liquor from twelve stills—Re.
Betā khājo ne moḷāṅ mārjo—Re.	Prayed “ Oh son, rejoice and be happy ”—Re.
Kātjo duniyā kera dukho—Re.	Destroy the evils of the world—Re.
Dukhū bhāgi bhūkū kar jo—Re Dehariyā	Drive away (these) and pain and hunger—Re. Dehariyā.

No. IV.—*The Song of Bhurya Bhil.*

The interest in this song lies in the fact of the Bhil placing the *tika* mark on the chief's forehead. This is, of course, a well-known practice in many places in which Rājput clans have ousted the allodial proprietors. The Jhābua State is situated in the south-west of the Central India Agency. The ruling family is Rāthor, an offshoot of the Jodhpur house. The fort of Pāwāngarh is in Gujarāt.

Bhuryo Pāvāno parthi ⁹ gāwure suwapeṅ āj	Bhuryo—I sing now of Bhurya, lord of Pāwāngarh district.
Bhuryo-Pāvāno gaḍhshī nikalyore mane wārowār	Bhuryo—(Once) he started out from Pāwāngarh fort in haste.
Bhuryo-Ayo kāne āyore Gamāni pāl ¹⁰	Bhuryo—He came travelling to the pāl of Gama.
Bhuryo-Bārā ne pādā ¹¹ tapere mukhyo nā āj	Bhuryo—There he became the lord over twelve Bhil Villages.
Bhuryo-Rājā Bhīmāṅi ¹² wahere Jhābūwe re gāmu	Bhuryo-Bhīmāni was then ruler of Jhābua.
Bhuryo-Majre ¹³ kāne teḍese Bhīmāni āj	Bhuryo—A messenger Bhimani sent (to Bhuryo saying) come and pay respects (to me).
Bhuryo-Majre kāne jāwere māre wāro wār	Bhuryo—Went at once to pay his respects.
Bhuryo-Aṅgli ne bāḍi tilūao mane kāḍe āj	Bhuryo—“ Cutting your finger (said the king) make the tilak (with blood) on me forthwith.
Bhuryo-Ne rājā kāne āli re Rājā ne āj	Bhuryo—So the Rājā gave him leave to rule.

¹ Hīḍā=H. Shidha (S. Shiddh), undressed grain with fuel for cooking, *i.e.*, supplies.

² Satin=Chhatis; warana=Cooked Vegetables. *c.f.* Marāthi Sāran, spices used for stuffing.

³ Hui=Soyi.

⁴ Aodānū, Pregnant.

⁵ Dhūmiā=Stem, dry stalk.

⁶ Kāsī=fresh.

⁷ Chani=Oil-mill.

⁸ Haro=liquor.

⁹ Parthi: lord (H. pāṛthivi).

¹⁰ Pāl: the pāls are certain local areas generally in possession of a section of the tribe.

¹¹ Pāda; Bhil settlements are called “ Bhil pādās,” *i.e.*, Bhil quarters.

¹² Bhimān Singh was the father of Kesho Dās who founded the present Jhābua State in 1584. Though never really ruler of Jhābua, he held the Bādnāwar district (now in Dhār State) in fief; wahere=Wase-re.

¹³ Majre: Salutation (Pers: mujra).

SECTION C—*concl'd.*SPECIMENS OF BHIL SONGS—*concl'd.**No. IV.—Song of Bhurya Bhil—concl'd.*

Bhuryo-khani ¹ ne khodi khūjo re Dewad no māl . . .	Bhuryo—"Plunder (said the king) to your heart's content, enjoy the wealth of Dohad."
Bhuryo-Kuti ² ne lūṭi khāḍore Dewada ³ no māl . . .	Bhuryo—Beat, plundered, and took possession of the wealth of Dohad.
Bhuryo-Luṭi kuti Bhuryo ne pāchhā āj . . .	Bhuryo—having looted and slain them Bhuryo came back.
Bhuryo-Awā kāne ayo ne Gāmāniyā pāl . . .	Bhuryo—So came to the pāl of Gama.
Bhuryo-Lugaḍe ⁴ ne dārū māngaḍe Bhuryo to āj . . .	Bhuryo—Then did Bhuryo order jars full of liquor.

¹ Khani: lit. dig up (S. khan).² Kuti: to pound, drub (S. Kuttan).³ Dohad town in Bombay Presidency.⁴ Lugaḍa: lit the frame of wood for carrying jars, etc., on donkeys. Here used for the jars themselves.

APPENDIX II.

Migration of Castes and Tribes into Central India and their distribution.

I.—INTRODUCTORY.

1. **Area defined.**—The Central India Agency is an arbitrarily constituted administrative unit for the purposes of political control and we cannot restrict the area to the present day political boundaries. The best way to define the area for our purposes is to imagine a triangle with the Narbada and Son for its hypotenuse and having for one side the valley of the Ganges and for the other river Chambal and the Chittor hills. Let us assume that the region round about Gwalior is the apex of this triangle. Then the area comprised within this triangle will include the Central India Agency as at present constituted, the state of Gwalior, the British Bundelkhand districts in the United Provinces and the valley of the Narbada lying in the Central Provinces.

2. **Physical features.**—To understand the ebb and flow of migration, into the area so defined, a knowledge of its physical features is absolutely essential. These have already been briefly touched upon in Chapter I of the Report and for the sake of convenience we may recapitulate them here. The most important of them is the range of the hills spreading from the borders of Gujarat to Rajmahal. The Vindhya range together with its offshoots and the Satpuras lie entirely in our region and to their north lies a table-land which gently slopes away to the Gangetic basin. The Vindhyan wall has served as an effective barrier across peninsular India and it has set the limit to every migration from the north to the south. Though in the centre the Vindhyas might have proved a formidable barrier, there are gaps at either end. Thus in western Malwa the Vindhyan gap easily lends a passage to Gujarat and its sea-ports. The eastern portion of the Vindhyas was crossed at Mahisatti (identified with Onkar Mandhatta on the Narbada) in early Buddhist times when it was a recognised route from the Deccan to the northern parts. It is however doubtful whether any large scale migration took place through this route.

3. **Main currents of migration.**—The main streams of migration to this region have come from the Indo-gangetic plain, from the region beyond the Chambal on the western side and from Gujarat. Evidence also points to the fact that there has been considerable movement in early times through the corridor along the Narbada valley from the Gujarat littoral. Migration from the area beyond the Chambal, probably dates from the time of the rise of the Rajput clans and there is evidence to believe that Malwa was colonised very much earlier than that part of the country. The connection between Gujarat and Malwa was well-established, as far as we know, in Buddhist times. Ujjain had then become a prominent place and Malwa was on the high-way. In considering the migration from the northern parts we have to bear in mind the following few facts :—

- (1) The contiguity of the Central Indian table-land to the densely-peopled parts of the Gangetic-doab, the centre and seat of ancient culture and civilization.
- (2) The absence of any physical barrier from the northern plains to the table-land till the Vindhyas are reached.
- (3) The fertility of Malwa and hence a coveted possession for strong and powerful Rulers.
- (4) The Central India regions have possessed low density. Being sparsely populated they have always sucked in people but have sent out very few.
- (5) We have also to bear in mind one important fact which is apt to be lost sight of. The waves of migration did not flood all the parts as we may be tempted to suppose. Civilization rose and fell according to the political fortunes and convulsions in the Gangetic plains. When there was anarchy in the northern regions, in parts of Central India the forests advanced and there was an extension of tribal rule.
- (6) In Malwa itself we have again, to recognise two regions as was done from the earliest times, *viz.*, western Malwa (Avanti) and eastern Malwa (Acara). The former may be approximately described as lying between 77° North and 22·5° East. (This may historically be not quite exact). Western Malwa has at all times been far more exposed than eastern Malwa or the eastern parts of Central India. It has received some share in all the racial incursions that have taken place into the northern plains. It has been subjected to the Scythian and the Hun invasions of the early historical times.
- (7) Lastly, practically the whole region lying to the east of western Malwa has been for a long time a partially opened up tract in places and entirely unopened area in

other parts. In one of his works Crooke wrote that the Central Indian jungle with its occasional patches of brushwood or coarse grass is rather a copse than a primeval forest. It is true that it stands no comparison with the forests of the Himalayas and neither has it the abundant and luxuriant foliage of the great forests. But the denuded and poor forests of Central India of to-day must have been different in the days gone by. They have undoubtedly suffered at the hands of the colonizers and its primitive inhabitants and probably also due to climatic changes. We have very little information so far on the last point. A reference in the *Arthashastra* reveals the fact that Avanti was a region of considerable rainfall and the precipitation for this region is given as 23 *dronas*. Only four centuries ago there were thick forests in eastern Malwa and further east it is recorded that the forests in Orehha were so thick that it occupied the Moghal armies several days in cutting a way through them.¹

4. **Factors of migration.**—We have next to consider what lies behind the movements of people. The causes are various and with the scanty material at our disposal it is often difficult to disentangle the various factors that have governed the movements of men. In the early times climatic changes, dessication of certain regions setting in motion movements of nomads, pressure of population, disturbed political conditions, conquest and colonisation, have all played their part in varying degrees. In more recent times, famine, religious persecution and colonisation have influenced migration. Generally all movements are primarily due to food. The task of isolating one or more of these factors is by no means easy and before we essay to do so and set up some kind of rough frame work within which we can get some glimpse of the movements of people, we must first deal with the baffling question of those primitive tribes who are inhabiting the hills and forests of these regions.

II.—EARLY RACIAL DRIFTS AND MIGRATION.

5. **The present day primitive tribes.**—The important primitive tribes of this region are Bhil, Gond, Korku, Kol, Baiga, and Saharia (Sonr). There are various offshoots of some of these tribes and they have already been noticed in the Chapter on Caste. Who are they and whence have they come? All the primitive tribes have the tradition that they have been the inhabitants of these regions from time immemorial and they are unable to point out to any migratory movement. The Gonds say they come from south which so far as our regions are concerned practically means Gondwana and they are an overflow into Central India from that part. The Bhils of the south-western Vindhya have some tradition of movement but that is merely a displacement from one place to another along the Vindhya. The Gonds speak a language which is classified as Dravidian. The Korku and the Kol (with whom we may associate the Baiga and the Bhil) once spoke a language which is classified as Austric. Linguistic considerations may go to suggest more than one racial drift. But it would be dangerous to assert any such movement on linguistic grounds alone.

6. **Defective knowledge about them.**—Much of their history is still in the realms of uncertainty and will remain so till expert investigators make an intensive and concentrated study. In the Chapter on Caste four broad tribal belts have been described. These have yet to be regionally surveyed and the Bhil area has to be split up and separately studied in the Satpuras, in the Vindhya and further west in Mewar. A systematic exploration of the prehistoric archaeology of the Vindhya-Kaimur system has to be undertaken. An extensive field work is necessary in the remoter parts of the Central Indian hills especially in south Rewa to secure ethnographic and anthropometric data. The materials obtained by these different studies are bound to form a valuable clue to many problems in the racial and cultural history of these parts.

7. **The pre-Dravidians.**—In the meanwhile, we may consider the problem, however unsatisfactory it may be, in the light of the few materials known or available so far. In doing so we shall not speculate whether early man arose in India or not. The early home of the modern types of men has not yet been satisfactorily located but let us assume that it is to be provisionally placed along what is now Sahara, Mesopotamia and Arabia. Man and vegetation flourish easily in temperate or tropical zone and it is believed in the glacial epoch of the Pleistocene period, a belt of Cyclonic storm lay over these zones. Sahara, now a vast desert, was then a grass-land. Peake and Fleure believe that the early type of man spread from these regions. "Among the people who retain the unlengthened head with the ancient prominent jaws and with spirally curved hair, we may mention the Andamanese. . . ; these are all very short, and very dark with broad flat noses."² If we construct the distribution of land and water with the coast line at the present 100 fathom or thereabout, Sumatra, Java, Borneo, Palawan would form a hooked peninsula attached to farther India and this will help us to understand their spread to these regions.³ Whether they spread from the supposed 'cradle' of modern man

¹ *Imperial Gazetteer of India, Central India, page 51.*

² *Corridors of Time, iv-184.*

³ *Ibid.*

or not, we start with a dim perception that several millenia before recorded history there was a dark negroid race of low culture characterised by a physical type of very short stature, low forehead and flat face and nose. This race we may term pre-Dravidian.

8. **All great racial migrations into India are from the West.**—If there is one fact which impresses upon us strongly in connection with the migrational history of India, it is this that all the great racial movements into India from the dawn of history up to the modern 18th century have been from the regions to the west and north-west of the Indian peninsula and they have been into India and not out of India. Its physical formation has been such that along the great plains, or in its coastal regions or in its highlands, the floods of invasions have spread themselves out in the vast area enclosed on three sides by the sea and closed on the northern side by the impenetrable mountain barrier. But India has always been a centre of secondary dispersion of culture and civilization towards east and farther east. It is therefore to the west we look for the migration of races into India unless stronger evidence is forthcoming to abandon this view. We have reason to ascribe that several migrations took place into India from the western direction.

9. **Migration of the Proto-mediterranean race.**—It may be hazarded as a point of view worth consideration that one of these took place due to sudden climatic changes. An important crisis occurred in the early history of man when the northern ice cap over Europe retreated and the climatic belt that lay over Sahara followed it. The grass-land of Sahara began to dry up. This resulted in the migration of the animals to more favoured regions and the hunters who hunted them followed them. These hunters spread towards the Nile and later on appear to have extended up to the Vindhyan hills in India and even to Ceylon.¹ These people largely lived on small game, shot with their bows and arrows and supplemented their diet by digging up edible roots with hoes of flint.² These people we may designate as the proto-mediterraneans. They conquered or blended with (whatever process took place if it did at all) the early pre-Dravidian element in these parts. Nothing very definite, however, is so far known about the presence of a Negrito element in the aboriginal population of India in general and in the primitive tribes of Central India in particular. These proto-mediterraneans constitute the first of the racial strata in the central parts of India and it is these whom we call the Munda tribes. They have at the present day everywhere been submerged by the later invasions and are mere remnants of a vanished people in the hills of Central India, represented by the Baiga, Kol, Saharia, Sonr, Korku and Bhil tribes. The Austric family of languages should be associated with these people and the Munda branch of this family still survives in island patches in the central regions.

10. **Their culture.**—Their long contact with the culture of the plains has modified their primitive culture to a very great extent and what little is left of it is difficult to reconstruct. They remain in spite of agriculture being compulsorily forced on them, hunters and food-gatherers by instinct. The art of cultivation has never been seriously acquired by them. The Baiga is an inveterate 'dhaya' (shifting) cultivator. So is the Sor in Bundelkhand who is a wretched cultivator. 'He sows his Jowar by jabbing the seeds in with a pointed stick.'³ Before the Korku became a wretched village drudge his life in the mountain haunts was not far different from the early hunters and food-gatherers. He practised shifting cultivation if it suited him. That was a precarious job but he had nothing to despair. Nature was bountiful in the forests. He would live on edible roots, wild yam, bamboo seeds, supplemented by the flesh of wild animals and by fish obtained by poisoning the pools.⁴ The Bhil who has been for long in contact with the Hindus has become so to say civilized but some of the Satpura Bhils are still very backward and live mostly on roots and berries and were formerly practising shifting cultivation. Of their material culture, the details are sadly lacking. The custom of erecting small upright stones as monuments to the dead among the Bhils, and of tattooing, belief in a soul as being born as an insect and certain ideas regarding metempsychosis, go to suggest that their culture was part of a widespread one.⁵

11. **Possible distribution.**—It would be interesting to attempt some kind of distribution of this submerged people. We have good reason to assume that they were far more widespread than in their present day mountain homes. Linguistic evidence goes to shew that in the Himalayas the Munda survivals are most apparent. Dr. Sten Konow believes that the Kolarians at one time occupied the vast area of northern India; that the existence of Korku tribe in the heart of India seems to point to the conclusion that people of a similar descendency have occupied a large territory in central parts of the country and probably also in the Deccan.⁶ The same authority holds that they influenced the germs of art, religion and philosophy.⁷ Judging by their present day distribution it would appear that from Gujarat across Malwa along the Vindhyas were the Bhils. Further north in Malwa were the Saharias or Savars stretching from

¹ *Corridors of Time*, III, 8.

² *Ibid.*

³ *Damoh District Gazetteer*.

⁴ Forsyth. *Highlands of Central India*.

⁵ For details see Appendix I.

⁶ J. A. S. B. 1925, No. 3, p. 315, quoted in *Pre-Muslim India* by Mr. V. Rangacharya, Huxley Press, Madras, page 67.

⁷ *Ibid.*

the borders of the Jumna-Chambal system across the peninsula to the north-east of the present day Madras Presidency. 'The most southern forms of Munda speech', says Sir George Grierson, 'are those spoken by Savaras and the Gadabas of north-east Madras. The former has been identified with the Suari of Pliny and the Sabaræ of Ptolemy. A wild tribe of the same name is mentioned in Sanskrit literature even so far back as in late Vedic times, as inhabiting the Deccan, so that the name can boast great antiquity.'¹ Thus this branch covered a wide expanse of territory though now separated and confined to the jungles of eastern Malwa or of Bundelkhand. Cunningham says "Indeed there are good reasons to believe that the Savaras were formerly the dominant branch of the great Kolarian family and that their power lasted down to a comparatively late period, when they were pushed aside by other Kolarian tribes in the north and east and by the Gonds in south. In the Saugor district I was informed that the Savaras had formerly fought with the Gonds and that the latter had conquered them by treacherously, making men drunk."² To the east of the Savara belt were the Kol, Baiga and other allied tribes in the Kaimur-Vindhyan hills, with a great extension towards Chota Nagpur and possibly even beyond. We have also some good evidence to believe that some of the offshoots of these tribes were in occupation of the northern Gangetic plain either before or at the time of the Aryan invasion into India. They have now passed into oblivion and possibly merged into the lower castes. The memory and tradition of at least three peoples are preserved. They are the Bhar, Cheru and Seori. The Census caste table does not show them. It is believed that the Hinduised tribal caste of Bharia returned from Rewa and other Baghelkhand States are descended from the ancient Bhars of whom Crooke says "The most probable supposition is that the Bhars were a Dravidian race closely allied to the Kols, Cherus and Seoris who at an early period succumbed to the invading Aryans. This is borne out by their physique and appearance which closely resemble that of the undoubted non-Aryan aborigines of the Vindhyan-Kaimur plateau."³ There is no doubt that the Bhars were once a widespread race. They were in north Rewa before the Rajputs displaced them and once a wide tract in northern India from Gorakhpur to Saugor was under their sway. They were very powerful in Oudh and in portions of the Gangetic doab.⁴ They have again a claim to antiquity as a tribe mentioned by Pliny in his list of the Indian races as the following quotation from McCrindle's *Ancient India* as described by Megasthenes and Arrian would show :—

"There is a very large island in the Ganges which is inhabited by a single tribe called Modogalingæ. Beyond are situated the Modubæ, Molindæ, the Uberæ with a handsome town of the same name", etc. The Modubæ (says an explanatory foot-note) represent beyond doubt the Moutiba, a people mentioned in the *Āitareya Brahmana* along with other non-Aryan tribes which occupied the country north of the Ganges at the time when the Brahmans, established their first settlements in the country. The Uberæ must be referred to the Bhars, a numerous race spread over the central districts of the region spoken of and extending as far as to Assam. The name is pronounced differently in different districts and variously written as Bors or Bhors, Bhowris, Barrilas and Bharhiyas, Bareyas, Baoris, Bharais, etc. The race though formerly powerful is now one of the lowest classes of the population."

The Cherus were also a powerful race and were the masters of the soil in the eastern Gangetic plain. Buchanan noticed a peculiar custom among them of appointing a Raja for every five or six families who is created in the Rajput fashion by the application of a mark or *thika* to the forehead. From all accounts these people appear to have advanced in their material culture more than their brethren who remained or preferred to remain in the inaccessible hills but they could not withstand the onslaught of the invading Aryans or the later invaders speaking Aryan languages. Their languages were strangled, their culture destroyed and in course of time not without struggles and set-backs on either side, they finally succumbed and perished.

12. The Dravidians—a branch of the Mediterranean race.—Subsequent to the migration of the proto-Mediterraneans, at a later period, there was another racial drift. Due to climatic changes or to the pressure of population, possibly from the area which Peake and Fleure call the Fertile Crescent, a branch of the Mediterranean race—the Dravida-speaking people, passed through Baluchistan and the Indus valley, down to Gujarat, the Deccan and the southern regions. Linguistic consideration shows that Sanskrit has been much modified by a good many Dravidian features and it has been well-established now that the Brahmi script itself from which all the Indian scripts have been derived is to be derived from the pictographic signs used by the people of the Indus valley civilization.⁵ If that is so, the Dravida-speaking people must have settled in the Gangetic valley also. It is extremely doubtful if they ever occupied the Central Indian plateau. It is also not possible that the invading Aryans could have driven them south. No such movement was possible through the Vindhyan barriers. The movement of the Dravida-speaking people to the south must have been along the west coast or even by sea. In the south their culture was influenced by the cultural migrations from Egypt and Mesopotamia. It is recognised the Mediterranean race possessed a higher culture and its migra-

¹ *Linguistic Survey of India*, volume I.

² Quoted in *Castes and Tribes of the Central Provinces*, Art. Savara.

³ *Castes and Tribes of the Central Provinces*, Art. Bharia.

⁴ Sherring *Hindu tribes and castes*. The Bhar tribe.

⁵ This has been pointed out to me in a private communication from the Census Commissioner.

III.—MIGRATION IN HISTORICAL TIMES.

15. In the previous section we have noted the present day distribution of the primitive tribes and suggested some possibilities of their migration. We can carry the migration history into the historical times more satisfactorily if we can fix certain arbitrary periods in the history of Central India. They may be set down as follows :—

1. From the time of the Aryan invasion of India to the rise of Buddhism.
2. Mauryan epoch to the invasion of Huns and other foreign hordes.
3. The rise and fall of Neo-Hinduism.
4. The Rule of Islam up to the downfall of the Moghal power.
5. Recent times.

16. **Period 1.**—The last of the pre-historic migrations was that of the Aryans who according to the commonly accepted views entered India from the north-west, occupied the Punjab first and then in the Gangetic doab evolved the complex Indo-Aryan culture and civilization. It is certain the Rigvedic Aryans did not migrate into Central India. The Central Indian rivers and the Vindhya are not mentioned in the early Vedic literature. The identification of the Bhils with Nishada is not quite certain. In the later Vedic period it appears that a tribe called Chedi had occupied the present day Bundelkhand. Later on we find that the Rajputs who rose in the third period appear under the name of the Chedis and a large tract of the country lying in the Narbada valley was designated as the land of the Chedis. Malwa was certainly colonised by the Aryans from the doab and in the early Buddhistic times the kingdom of Ujjain was one of the 16 Aryan tribes ruling in different parts of northern India. With the rise of Buddhism Ujjain was connected with Magadha by way of Sanchi and Vidisha (modern Bisanagar) in eastern Malwa and Bharut now in Nagod State in the Baghelkhand Agency. The colony of the Aryans was perhaps dotted over all these regions surrounded in the midst of the non-Aryan population. From the list of Megasthenes we read of another tribe of uncertain affiliation, called Charmæ who have been identified as residing in Charmamandala and are believed to be represented by the Chamars of Bundelkhand and the parts adjacent to the basin of the Ganges.¹ By a process of enslavement or by degradation or of mixed marriages or by other causes, the lowest elements in the caste composition of the present day, were formed. At least the process of formation started in this early period and their ranks have been reinforced for ages till the caste system obtained a fixity and rigidity. Of such castes, mention may be made of, Basor, Balai, Chamar, Kotwar, Arakh, Dhantik, Dahait, etc. They have no tradition of migration. Excepting the Basor and the Chamar, the rest are generally employed as village menials and watchmen from time immemorial. They are the authorities on village boundaries and the *Arthashastra* which in main depicts the pre-Buddhistic India lays down that the interior of the kingdom should be watched by archers, hunters, chandalas and wild tribes.² The penetration of the Aryans to the different parts of Central India seems to have been achieved in the post-Vedic and the early Buddhistic period. Thus the Son (Sanskrit Suvarna or 'gold'; also called Hiranyavata, possibly corrupted to Erranooboas of Arrian), the Ken (Sanskrit Karnavati, the Kainas of Arrian), the Dhasan (Dasharana, possibly the Dasaron of Ptolemy), the Betwa (Sanskrit Vetravati) and the Chambal (Sanskrit Charmanvati) received their names in the Indo-Aryan language and possess the earliest historical mentions.

17. **Period 2.**—Perhaps in the Mauryan epoch arose the complexity if not the rigidity of the caste system and the association of caste with craft thus paving the way for the formation of the various occupational and functional castes. Castes were also forming due to the interaction of the old four divisions. In the dark period between the collapse of the Mauryan power and the rise of the Guptas, very little is known about the movement of people. It is tolerably certain that the eastern parts of Central India passed under tribal rule with the weakening of the authority of the Aryan Rulers. Western Malwa was ruled by the Sakas or the Scythians. Political subjection by the Sakas or the Huns need not necessarily always mean a migration and settlement of them in large numbers in tracts which according to history were ruled by them. It is not quite safe to assume the Scythic or the Hun element necessarily modified the composition of the population by the nature of the political rule. At the same time we have to take note of the fact that the Sakas ruled western Malwa from Ujjain and further north were the tribal republics of the Malavas and the Abhiras. It is supposed that the former have given the name to Malwa though as a distinct people they have disappeared or merged with the general population. The Abhiras from whom the modern Ahirs are said to have descended were a widespread people and they have given the name of Ahirwara to the country between Gwalior and Jhansi. According to the *Khandesh District Gazetteer*³, the Abhiras were on the North-West Frontier before the Christian era. In the third century A.D. they were in lower Sindh and north Gujarat and next they appear to have passed down the Tapti valley into Khandesh. It is very probable these tribes were the advance guard of the vast migratory hordes that poured into India in the first few centuries of the Christian era. After the fall of the Guptas, there

¹ McCrindle's *Ancient India*, 150-151 and foot-note.

² *Arthashastra*, translated by Dr. R. Shama Sastry, Bk. II, Chapter I.

³ Volume XII (1880), 39.

was again an inroad of the barbarians known to history as the white Huns. Malwa was ruled by their chief Mihirakula, a Hun tyrant. The rule of the Huns was terminated by a local rising under a Raja of Central India. After a brief spell of the vigorous rule of Harsha, there followed a very considerable adjustment in the Hindu society and a great stir in the migration history of these parts. Before we consider the nature of this stir, we note two small points which are of some significance. Compare the empire of Asoka, of Samudragupta and of Harsha on a map of India as given in say Vincent Smith's early history of India. The country to the west of Central India (the present day Rajputana) and to the east (the present day eastern Central Provinces districts) are practically *terra incognita* in the time of the Mauryas, the Guptas and even of Harsha. The western boundary of Central India has always been the Chambal as it is even today. Secondly the western regions in Harsha's time began to be peopled and already places like Bhilmal and others attract attention.

18. **Period 3¹.**—In the time of the Mauryas and the Guptas the seat of civilization was Magadha but with the downfall of their power, it shifted to the Doab. Kanauj took the place of Pataliputra as the radiating centre of ancient civilization. The eastern parts of Central India which now and then were brought under the sway of a powerful northern Ruler again came under the rule of the primitive tribes. In this period two other movements are seen at work. One is the growth of neo-Hinduism which appealed to the people at large and which in course of its evolution absorbed a good deal of the non-Aryan cult. It became broad-based and not exclusive as the Vedic religion of the Aryans. The second is the process of absorption into the fold of this neo-Hinduism of the foreign elements that were present in India at that time as well as the aboriginal element in the existing population. The classification of society no longer proceeded on racial lines but on occupations. "The higher the caste the more numerous and more honourable the occupations open to it."

There is a difference of opinion as to the rise of the various Rajput clans and a certain amount of fiction still persists that the Rajputs are descended from the ancient Kshatriyas. It requires some stretch of imagination and credulity to believe that the Rajputs of Malwa are descended from the Kshatriya kings of Avanti of the early Buddhistic times, ignoring all the kaleidoscopic changes of more than two millenia. The generally accepted historical view is that some of the renowned clans like the Parihars, Solankis, Chauhans and the Paramaras have a foreign origin. In the early history of India, three definite irruptions of the foreign barbarians have now been recognised. They, in order, are of the Sakas, the Yuechi or the Kushans and the Huns. It is not known definitely how far the first two have contributed to the composition of the Rajput clans but the Huns together with the allied swarms decidedly have. The aristocratic sections amongst the foreigners became the ruling clans while the others in course of time became the cultivating classes like the Jat or the Gujar. The foreigners established their kingdom in the early medieval times and one of them was at Bhilmal and the ruling dynasty belonged to the Pratihara (Parihar) clan of the Gurjara tribe. The familiar legend of the Agnikula Rajputs, the Pawar (Paramara), Parihar, Chauhan and Solanki is perhaps a convenient allegory to explain their purification and absorption into the Hindu fold. The country to the west and north of Chambal became the home of the early clan settlements. Some of the other clans to the east of Chambal, like the Chandel, Bundela, Gaharwar, etc., are supposed to have sprung from the Hinduised aboriginal elements. The Gaharwars are associated with the Bhars and the Bundelas and the northern Rathors are associated with the Gaharwars.

The rise of these clans is a most important period in our discussion. They were a restless and a vigorous people constantly seeking for new settlements. This movement has gone on for several centuries till the establishment of British power in India. The quest for settlements set in train a widespread migration of clans over a large part of upper India. Kanauj was a great focus from which the migrations spread and from these a dispersal of people took place to reinforce the distant colonies and settlements. It is even believed that the functional and occupational castes migrated from there to different parts of western and eastern India.

The distribution of the important clans by locality is enumerated below :—

The Solankis were the rulers of Gujarat and Kathiawar and their capital was Anhilvad Patan. The Chauhans, a powerful clan occupied the whole country from Mount Abu to Hissar and from the Aravallis to the northern tracts of Bundelkhand. The Kachhwahas held Gwalior and Narwar while the Tomars occupied Hissar and the country round about Delhi.

Excepting the Kachhwahas, the above-mentioned clans were to the west of the Chambal. Of the clans settled in Central India, the most famous of them were the Paramaras of Malwa who appear to have migrated from a vicinity near Mount Abu. Further east in the Narbada valley were the Kalchuris, who are also known as the Chedi or the Haihaya or Haihaivansi Rajputs. It is likely they were descended from one of the early Scythian or foreign tribes. Their first capital was Maheswar on the Narbada which is now in Indore State. Later on the Kalchuris appear to have extended their power into the heart of what is now the Central Provinces possibly being subjected to the pressure of the growing powers of the Paramaras of Malwa.

¹ This section and a portion of the next one are entirely based on Vincent Smith's *Early history of India* (1914), Chapter XIV and on J. Kennedy's brilliant essay in Chapter VIII of the *Imperial Gazetteer of India*, Volume II.

The Chedi country was divided into two kingdoms, Western Chedi or Dahala with the capital near the modern Jubbulpore and Eastern Chedi or Mahakosala with its capital at Ratanpur. In the recurrence of these classical names of the Epic period we observe how the newly absorbed elements took upon them the old mantles and as the saying goes that history repeats itself, several centuries later when the Great Moghal was dead, we see the same process at work when every power that rose was appropriating to itself the tattered and torn mantle of the Moghals. Such has been the strength and vitality of tradition and the strange influence of fiction on Indian thought in its long evolution.

To the north of Narbada and up to the Jumna, in the Bundelkhand area, were the Chandels. Before the Chandels, the Parihars, allied to the Gurjara-Pratihars of Rajputana were settled and their capital was at Mau-Sahaniya, now a small road-side village between the cantonment of Nowgong and Chhatarpur. The Chandels who are believed to have been Hinduised Bhars overthrew the Parihars and subsequently rose to great fame and have left imperishable monuments in the temples at Khajuraho now in Chhatarpur State. To the north beyond the Ganges, particularly towards the east of Allahabad, the Bhars and other tribes held the country and at Benares were the Gaharwars who are also associated with the Bhars. The clan settlements were wider still but the distribution is restricted to the central regions. There was incessant struggle between these various clans which occupies a great portion of the history of this period. It may be, as Vincent Smith holds, that there was a secular struggle between the foreign Rajputs and the indigenous Rajputs. Whatever it may be, the Paramaras, the Chedis and the Chandels disappeared after the struggle and the Bundelas who are descended from the Gaharwars did not rise into power till the 15th century.

19. **Period 4.**—The incursion of the northern barbarians—this time professing a militant religion—set in motion further migration in a helter skelter fashion. Delhi and Kanauj fell to the invaders. Islam dealt a final blow to the warring Chauhans and the Chandels and the Rajput clans were 'scattered on the face of northern India'. The Solanki power in Gujarat was shattered and Anhilvad Patan destroyed. These again resulted in a different distribution of the clans.

When Kanauj fell the Gaharwar clan migrated to the deserts of Marwar in Rajputana and in later history came to be known as the Rathors. In the Muhammadan times a branch of these Rathors carved out principalities in western Malwa. The Kachhwahas driven away from north Gwalior later rose into power in Amber and they have left small colonies in Central India. The Tomars built up their power in Gwalior when the Muhammadans were fighting amongst themselves. In Malwa the Paramaras sunk into insignificance when reduced by the Solanki and Chedi confederacy and after a rule by the Tomara and Chauhan clans, Malwa passed into the hands of the Muslims. The Chedis disappear from their habitat towards the end of the twelfth century. They were supplanted by the Baghels. On the question of the migration of Baghels the *Rewa State Gazetteer* which tries to give an account of their history according to the Baghel tradition, is somewhat confusing. The Baghel clan is a branch of the Solankis and it appears that they migrated from Gujarat and founded the State of Rewa. The Solankis were in touch with the Chedis through Malwa. It is more probable they migrated from Gujarat through the Narbada valley and first occupied southern Rewa than they came from northern India and conquered the Rewa territories. According to the Baghel account the Baghel chief Karandev married a daughter of the Haihaya chief of Ratanpur and the fort of Bandogarh was given in dowry to the Baghel chief. The probabilities are the Baghels supplanted the Haihayas, first extended their rule to the wild country below the Kaimur and later on to the plains to the north of the Kaimur range. The Kalchuris are now found in small numbers in few of the Rewa villages and their cranial measurements have been taken by Dr. Guha of the Zoological Survey of India. Small colonies of Chauhans were planted in central and northern Malwa while the eastern parts of Central India received a contingent of Chauhans and other clans from the tracts round about Kanauj.

Driven everywhere from the fertile plains by the victorious onslaught of the forces of Islam, the Rajput clans had perforce to seek shelter in inhospitable and inaccessible places and this led to their closer contact with the primitive tribes in the Vindhya. It is often thought that the Aryans were responsible for the subjugation and degradation of the pre-Aryan indigene. That was perhaps true in the plains but in the less inaccessible parts the latter maintained a good deal of independence and as we have seen previously they again and again extended their rule and power over those portions from which they were dispossessed. Further it is doubtful if the Aryan conqueror ever waged incessant struggle against them. The conqueror was soon absorbed and a mixed culture arose with the Aryan characteristics predominating. We should rather look to the period of Rajput settlement for the disintegration of tribal areas, for the disappearance of certain aboriginal tribes and for the formation of the Hinduised aboriginal castes. This was almost inevitable for the Rajputs could no longer maintain an independent existence in the fertile plains and they had to carve out principalities in the desert, mountain and forest regions. In the Vindhya Rajput colonies were planted after dispossessing the Bhils from their possessions. The Bundelas rose into power by displacing the Khangars and further east the Bhars, Cherus, Khairwars and others were annihilated after an incessant struggle against the Rajputs.

It would appear that the migration of many of the principal castes took place in the Muhammadan period. Malcolm wrote: "These provinces were amongst the most early subjected to Muhammadan power; and it would appear from their present population, that a great proportion of Hindus of all tribes and classes, followed the conquerors from Hindustan. Subsequent invasions from Gujarat poured another tide over their plains and almost all trace of their original inhabitants is lost."¹

20. **Period 5.**—In recent times the Mahratta invasion of Malwa is the only outstanding event in the migration history of these parts. It is recorded that the Andhras—a southern people penetrated into Malwa after the fall of the Mauryan power. Except for this isolated incursion, no movement has taken place from the south of the Vindhya. The political migration of the Marathas is therefore unique in the traditional history of Central India. They were the last to add one more strand to the diversified composition of the Central Indian population.

IV.—RACE COMPOSITION.

21. **Racial types of the population.**—A few words may be added, not so much by way of elucidation as of drawing attention to the snares involved, with regard to the question of the race composition. Into what physical types should the population be distributed—Pre-Dravidian, Munda, Indo-Aryan or Aryo-Dravida? Before we pin our faith to any of these labels, it is best to remember the frequent migrations and the consequent changes in the population that have ceaselessly gone on for ages. While culture, custom and social organisation have been evolving the racial stocks who have been handing them over from generation to generation need not necessarily have remained constant in type. Waves of foreign elements have been absorbed in the earlier days and they have modified the composition of the population. No one would therefore be disposed to disagree with the excellent dictum of Boas "that a people may remain constant in type and language and change in culture; that it may remain constant in type but change in language; or that it may remain constant in language and change in type and culture."² The presence of an Aryan strain in the population of Central India may be admitted but it is not predominant as a type. It has been overwhelmed by the non-Aryan elements everywhere but the culture and the languages are thoroughly Aryan in derivation and they have completely submerged and overlaid the pre-Aryan elements. In many cases when we use the label Aryan at the present time, we are really connoting the speakers of the Aryan tongues and the possessors of the Aryan culture rather than the physical type of the Rigvedic Aryans. "The lasting gift bequeathed by the Aryans", says Mr. Gordon Childe, "to the conquered people was neither a higher material culture nor a superior physique but that which we mentioned in the first chapter—a more excellent language and the mentality it generated. The physical qualities of that stock did enable them by the bare fact of superior strength to conquer even more advanced peoples and so to impose their language on areas from which their bodily type has almost completely vanished. This is the truth underlying the panegyrics of the Germanists: the Nordics' superiority in physique fitted them to be the vehicles of a superior language."³ The truth of this sober but accurate estimate is apparent when we consider the origin and spread of the present day population in Central India.

These desultory notes which I have set out are merely a foot-note to the study of vast and interesting problems concerning the people of Central India. Such a study is beyond the scope of a Census Report and it is moreover the work for a trained expert. My object is mainly confined to draw attention to few points. One great need is the study of human geography and the control exercised on man and his movements by such geographical factors as climate, relief of land, and the distribution of flora and fauna. Secondly, wherever necessary we should cease to be bound by the present day arbitrarily constituted political boundaries. Such areas like Central India are mere geographical expressions without any precise meaning and they are heterogeneous. Thirdly, to speak of Rajput or Brahman or any other caste without reference to locality in Central India is misleading and is specially to be borne in mind when securing anthropometric data. Nothing is so fatal to the accuracy of the statistics of the physical types of the living population as an ignorance of the tradition, history and the regional distribution of the types chosen. Lastly, there are innumerable questions which one may be tempted to ask. What for example is the affiliation of the lower castes to the existing hill population. What causes a great variation in the different sections of the population though groups of them possess the same culture-forms such as traditions, customs and beliefs. How far cultural and regional variations stand in the way of the fusion of similarly scattered groups. What are the racial types, as distinct from the ethnic labels in current use, in the population and how far are they as an individual and separate factor responsible in influencing the capacity to develop or to retard the culture and civilization of the different peoples. In relation to all such and other enquiries the Census statistics attain considerable value.

¹ *Memoir*, ii, 3.

² Quoted in the article on Aryans in the *Encyclopædia Britannica*, 14th edition.

³ Gordon Childe. *The Aryans* 1926, 211-212.

V.—SOME MIGRATION DATA.

22. Before setting out the data for some castes and correlating them with the Census figures as regards their present day distribution, the more important castes may be arranged as in the table below. The list is incomplete as there are some castes about which our information is indefinite or lacking. The primitive tribes are excluded from the list.

Castes for which some tradition of migration exists.	Castes known to have no tradition for migration.	Mixed Rajput castes.
1	2	3
1. Ahir. 2. Bania. 3. Brahman. 4. Dhangar. 5. Galaria. 6. Gujar. 7. Jat. 8. Kachhi. 9. Kayastha. 10. Khati. 11. Kunbi. 12. Kurmi. 13. Lodhi. 14. Maratha. 15. Rajput.	1. Balai. 2. Basor. 3. Chamar. 4. Dhanuk. 5. Dhangar. 6. Dahait. 7. Kotwar. 8. Arakh.	1. Bagri. 2. Banjara. 3. Bedia. 4. Dangi. 5. Dhakad. 6. Deswali Mina. 7. Kir. 8. Kirar. 9. Moghia. 10. Charan. 11. Sirvi. 12. Sondhia.

23. **Brahman.**—It is a very interesting fact that the Brahmans in Central India are all migrants, though they have now become localised in the different parts of the Agency and form separate endogamous groups. The main classes are Malwi, Nemari, Bundelkhandi, Marwari, Dakshani and Mewari. The last three are migrants as their names themselves would suggest. With the exception of the Dakshani Brahmans who came with the Marathas in the 18th century, the Brahmans of Malwa, Bundelkhand and Baghelkhand are early settlers but none can go very far back. There is sufficient reason to hold that Malwa received the Brahman immigrant population earlier than the eastern parts which were under the rule of the primitive tribes for few centuries after the dispersal of the Rajputs from northern India. The immigrants to Malwa have mostly come from Gujarat and Rajputana while the eastern parts have received the Brahman population wholly from the Gangetic *doub*.

The details for the immigration of the Brahmans to Malwa are set out in the caste chapter of the 1901 Report of this Agency. For the sake of convenience they are summarised here briefly. Malwi Audumbar (Panch Dravid), Chawise (Panch Dravid) of whom ten families are said to have come into Malwa, Jambu (Panch Dravid), Audumbar Potachor (Panch Dravid) and Audumbar Rodwal (Panch Dravid) all these have come from Gujarat. The Malwi Audich (Panch Gaur) came from north of India originally, the parent stock being found near Delhi. Moolraj, Raja of Gujarat, settled some of these Brahmans in his country and the Malwi section is sprung from the Gujarat section which is known as Sahasra as 1,000 families were brought into Gujarat.

The Gujar Gaur Malvi Brahmans (Panch Gaur) originally came from northern India but the Malvi group appears to have come from Gujarat. The Tiwari, Mewari and Mewari Shrigaud (Panch Gaur) have come from Mewar. The Naramdeo Brahmans on the banks of the Narbada appear to be a purely local group.

Of the eastern Brahmans, the Sanadhya (Panch Gaur) came originally from the country round about Muttra. The Bhagors derive their name from the place of residence. The original home of the Jijhotias of Bundelkhand is the country between the Ganges and the Jumna. They were introduced into Central India by Jujhar Singh, Raja of Orchha, who gave them grants of land. The Sarwaris are mainly found in Baghelkhand and have come from Gorakhpur and other eastern districts of the United Provinces.

Migration from Gujarat side and the west of Central India is due to famine or religious persecution. Several castes in Central India give out also that they came to Malwa, which has been a proverbially favoured region due to famine elsewhere.

The following table shows the distribution of the main Brahman sub-classes according to the three territorial divisions:—

Brahman sub-classes.	Total.	Malwa.	Bundelkhand.	Baghelkhand.
1	2	3	4	5
Bhagor	11,167	4,043	7,029	95
Dakshani	18,890	17,999	391	500
Jijhotia	48,879	4,452	43,562	865
Kanaujia	44,565	8,990	32,529	3,046
Sanadhya	33,192	15,688	16,456	1,048
Sarwaria	299,022	1,622	24,167	273,233
Shrigaud	9,834	9,432	270	132

24. **Bania.**—So far known there are very few local groups of the Banias in Malwa. Tradition has it that there were very wealthy mercantile classes in the days of the Paramaras but there is no authentic information. In Malwa, they are all settlers in recent times either from Gujarat or from Rajputana. Ujjain perhaps had the oldest colony; their settlement in Indore is not more than a century or a century and a half old. The larger influx of the Banias from Rajputana dates from the time of the Maratha rule. The former opium trade in Malwa attracted a considerable colony of mercantile classes. The Agarwals are from Delhi and Hissar side. The Oswal, Porwal and Mahesri Banias have come from Rajputana. In the east the main divisions are Gahoi, Golapurab, Kasaundhan and Kesarwani. The original head-quarter of Gahoi Banias is said to be Kharagpur in Bundelkhand. Some of these classes are local groups while others like Kesarwani may have come from the trans-Jumna tracts. The distribution of the Bania sub-castes is given below :—

Bania sub-castes.	Total.	Malwa.	Bundelkhand.	Baghelkhand.
1	2	3	4	5
Agarwal	23,684	14,918	4,517	4,249
Gahoi	14,687	1,093	13,052	542
Golapurab	2,835	35	2,800	..
Kasaundhan	6,373	21	315	6,037
Kesarwani	14,286	186	308	13,792
Mahesri	9,952	9,908	5	39
Oswal	25,255	23,192	1,376	687
Porwal	23,285	15,548	6,688	1,049
Saraogi	4,346	3,840	506	..

25. **Rajput.**—The distribution of the Rajputs closely follows the migrational history which has already been set forth in a previous section. The Bundela Rajputs have no tradition for migration.

26. **Certain main castes.—Ahir.**—As already mentioned the word Ahir is derived from Abhira—a tribe of great antiquity. The Abhiras were once a widespread people in northern

District.	Strength.
1	2
Narwar	26,505
Isagarh	37,373
Bhilsa	10,563
Bhind	15,163
Gird	15,774
Shajapur	7,051

and Central India and also in the Deccan. They had perhaps also a southern extension for according to the *Cambridge history of Ancient India* 'a race of uncertain affinity was the Ayar, who in many respects resembled the Abhiras of Northern India and seem to have brought into the south the worship of the herdsman god Krishna'. The tract to the east of Malwa and west of the Betwa river including Jhansi, Sironj, etc., is still known as Ahirwara. The Ahir population is found in these parts and has spread further

east but not towards the central Malwa plateau. The line runs from Bhopal to Orchha, Bijawar, Chhatarpur, Panna, Maihar, and Rewa. The marginal table gives figures for the northern Gwalior districts which have returned the bulk of the Ahirs from that State. In Indore 13,845 Ahirs out of the total strength of 23,830 have been returned from the Nimar district to which place the Ahir element has spread from the Khandesh side.

27. **Gujar.**—Historically a well-known people and it is not necessary to mention their origin here. The Gujars have spread into Central India from the west of Chambal. They are found in Malwa and northern Gwalior. In Malwa they are less in evidence in the western and south-western Malwa. In the east they have not spread at all. In the Central Provinces they are found in the Hoshangabad and Nimar districts, and are supposed to have migrated in the 16th century from Gwalior. Their distribution in Gwalior and Indore is given below :—

Gwalior State	119,314	Indore State	47,103
Ujjain	10,686	Rampura Bhanpura	14,021
Mandsaor	12,766	Mahidpur	8,281
Shajapur	27,162	Nimar	17,942
Tanwarghar	27,162	Nemawar	4,847
Narwar	10,835		

Considering the fact that they have not colonised central Malwa but the Narbada valley shows they have migrated in earlier times to the more unopened parts below the Vindhyas and have spread on either side of the Narbada.

28. **Gadaria.**—They are spread everywhere though they are concentrated in Bundelkhand. In northern Malwa they say they have come from the East. Nothing is known about their movements.

29. **Jat.**—This caste appears to have migrated originally from the west of Chambal, the country round about Bharatpur. It entered Hoshangabad district of the Central Provinces in the 18th century, migrating from Bharatpur and halting in Marwar on the way. The Jats in northern Malwa have also a tradition that they migrated there from Bharatpur due to famine. This appears to be borne out by their present day distribution. In north Gwalior they are

in the Saugor district of the Central Provinces and the bulk of the Gwalior Dangis are returned from north Gwalior. According to the *Central Provinces Castes and Tribe*, the Dangis migrated there in the 11th century. Their distribution shows they have migrated through northern Malwa and Bhopal. The Kirars are exclusively found in Bhopal and in the Central Provinces it is recorded they left Gwalior about 1468 A.D. under two of their leaders and settled in Hoshangabad district. In 1931 the Kirars in Gwalior numbered 75,897, the bulk of whom were enumerated in the northern districts of that State and very few in the Malwa districts. Their distribution seems to corroborate this tradition.

34. **Loda.**—In north Malwa they claim to have come from Lohargarh in Rajputana. After the fall of Prithvi Raj they went to Lohargarh and then migrated to Malwa. In the Betul and Hoshangabad districts of the Central Provinces they are considered to have immigrated there from Central India in the fifteenth century. In Central India they are now exclusively found in the Bhopal Agency. The Lodhis, a much more numerous group, are largely found in the east to which place they have spread from the Gangetic plains.

35. **Kayastha.**—We have the authority of Malcolm that the Kayasthas were brought into Malwa by the Muslim conquerors. Some of the families trace their settlement from the earliest Muslim conquest; many are of more recent date.

The following table shows the territorial distribution of certain main castes :—

Caste.	Total.	Malwa.	Bundel- khand.	Baghel khand
1	2	3	4	5
Ahir	233,782	51,931	102,609	79,242
Gujar	84,813	79,396	5,146	271
Jat	28,135	27,358	755	22
Gadaria	98,350	36,500	46,730	15,120
Kachhi	224,212	44,803	113,562	65,847
Khati	64,649	64,649
Kunbi	42,182	32,188	..	9,994
Kurmi	205,371	64,219	37,810	103,342
Loda	19,226	19,224	2	.
Lodhi	135,554	48,147	80,669	6,738
Kayastha	37,092	13,090	15,124	8,878
Dangi	45,064	38,899	6,062	103
Dhakad	34,283	34,256	1	2
Kirar	32,822	30,151	2,664	7

APPENDIX III.

The Depressed Classes.

1. **The term depressed classes.**—Of all the terms that have acquired prominence or notoriety (as the case may be) in recent times none is so depressing to deal with from the point of view of Census statistics as the term 'depressed' classes. Ask any two people what they understand by it. They will without fail give you widely different but sufficiently confusing answers. That is because nobody yet knows whom to call or stigmatise as depressed and much also depends on the purpose for which a person should be considered as depressed. The term has nowhere been satisfactorily and accurately defined. It is sometimes associated with such synonyms as the suppressed or submerged classes which are meant to invoke your sympathy rather than convey any precise meaning. In Central India nobody seems to worry over the question as to who is depressed and who is not. As the Census Superintendent is bound to present the statistics for them he more than anybody else is worried about his submerged tenth. In this voiceless region, he too cannot maintain his silence. He is therefore compelled to listen to the din and clamour of the external voices and try to see what they mean.

It appears that the problem of the depressed classes has a political as well as a social side. The former for obvious reasons is out of court so far as Central India is concerned and so is that much of the social aspect as trenches upon the political or administrative side. In this Agency there is yet no movement for the classification of the depressed classes or for 'raising' them. The politico-social aspects of the movement have not reared their heads anywhere and it would be outside my province to take cognizance of forces that are working elsewhere. As I had to make a list of the depressed classes to obtain the necessary statistics for Provincial table II and the social map, I propose to state briefly who constitute the so-called depressed classes and on what considerations.

2. **How recognised.**—The depressed classes are first arrived at by a process of exclusion and then distinguished by certain unsatisfactory tests. Literacy forms no criterion for we will have to classify almost the entire population as depressed. The primitive tribes are excluded because they have a distinct culture and social organisation of their own. Then there are certain wandering castes such as Nat, Pardhi, Bahelia, etc., with no fixed abode and no definite place in the social hierarchy but caught in the eddying currents of Hinduism. There are again the criminal tribes like Sansi, Kanjar, Moghia and others. All these are excluded from the category of the depressed classes which is restricted to cover only those castes which are considered as untouchable, *i.e.*, whose contact with the higher castes causes pollution and who are denied access to places of worship and to the use of public wells.

3. **Distinguishing characteristics.**—Untouchability is the overwhelming characteristic of the depressed classes and to this should be added isolation and servility arising out of degradation.¹ The rigour of these characteristics varies in different parts of India. In the south where the caste system was grafted at a later date untouchability is carried a step further and there we find unapproachability. In the Deccan or Gujarat also the problem appears to exist. A Mahar or a Dher in former times had to hang an earthen pot round his neck to hold his spittle, was made to drag thorns to wipe out his footsteps, and when a Brahman came near was compelled to lie far away on his face, lest his shadow fall on him and pollute him.²

Now, in Central India there are no castes whose presence by proximity would cause pollution, whose very approach would make the Brahman or any high caste man fly, and who are considered so degraded as to be condemned to a life of servility and put out of the pale of society. No restriction is imposed upon them in frequenting the public thoroughfares or in acquiring land for cultivation. But untouchability in some form does exist in few of the lowest castes and before we deal with the degree and nature of their untouchability it may be interesting to notice the probable origin of the impure castes in these parts.

4. **Probable origin of the impure castes.**—One theory of their origin is racial. The Aryan conquerors subjugated the indigene, made them their serfs and condemned them to the lowest of occupations. It is probable the Aryans subdued the aboriginal tribes of the plains *en masse* and turned them into helots wherever they could not exterminate them. That was possible in the regions where they settled down but where they ruled in small colonies as it appears to be the case in Central India³ it is not possible they could have reduced the whole population to one of servitude. With the evolution of caste system, certain occupations came to be associated with the degraded classes and persons who had fallen out of caste were also

¹ Report of the Depressed classes and aboriginal tribes Committee, Bombay Presidency, 1930.

² Tribes and Castes of Bombay, Art. Mahar.

³ See also Tribes and Castes of the Central Provinces, Vol. I, para. 40.

condemned to these low occupations. Thus racial conquest, fruits of mixed marriages in early times and occupation—all these three should be held as having contributed in turn to the formation of the impure castes.

The word *Chandala* to denote an outcaste person has become an approbrious term of abuse. But some of the despised tribes of the early days like *Chandala*, *Pukkusa* who hunted animals that live in holes and *Nishada*—a fisherman all had a considerably respectable pedigree according to Manu. Some of them are cited below for purposes of illustration¹ :—

Name.	Pedigree.	Proportion of Brahman Kshatriya, Vaisya and Sudra blood.	Occupation and Residence.
1	2	3	4
Nishada	{ Brahman father . Sudra mother. .	{ Half Brahman . Half Sudra . .	{ Fisherman.
Chandala	{ Sudra father . . Brahman mother	{ Half Sudra . . . Half Brahman . .	{ Most degraded of mortals.
Pukkusa	{ Nishada father . Sudra mother. .	{ $\frac{1}{4}$ Brahman . . . $\frac{3}{4}$ Sudra	{ Hunts animals that lie in holes.
Karavera	{ Nishada father . Vaidiha mother .	{ $\frac{1}{2}$ Brahman . . . $\frac{1}{4}$ Vaisya $\frac{1}{4}$ Sudra	{ Leather trader.
Sopaka	{ Chandala father . Pukkusa mother .	{ $\frac{3}{8}$ Brahman . . . $\frac{5}{8}$ Sudra	{ A simple wretch.
Pandusopaka	{ Chandala father . Vaidiha mother .	{ $\frac{3}{8}$ Brahman . . . $\frac{1}{4}$ Vaisya $\frac{1}{8}$ Sudra	{ Works in canes and reeds.

In this pedigree of Manu the interesting thing to notice is that he gives a high proportion of Brahmanical strain even to the despised classes though he condemns the progeny of these mixed marriages to the degraded occupations. Even a law-giver can be irrational and for obscure reason Manu held the carpenter the most degraded of mortals and gave him the pedigree of a Sudra father and a Vaisya mother. The racial factor in the origin of impure caste is not without interest. "If the workers in leather of the present day are lineal descendants of the workers in leather of Manu's time, the Chamars may fairly consider themselves of no mean degree and may hold up their heads boldly in the presence of the superior castes."² Two other points require notice in connection with the above table. Certain castes are condemned to live outside the village or town and the attitude of contempt towards the degraded is clearly shown by approbrious epithets. It is likely with the development of caste endogamy, the earlier racial distinctions were obliterated for in the frame work of the caste system every one could be assigned a place. The impurity of castes came to depend more and more upon certain occupations which were despised. In Buddhistic times the basket maker, the weaver, the chariot maker and so on were held in less esteem or despised according to the degree of revulsion towards any particular calling. Perhaps a greater tolerance was shown towards the despised classes and no bar sinister was attached to them in those parts where Brahmanism was not all powerful. The same cannot be said when Brahmanism obtained ascendancy at a later period for we read from the account of the Chinese traveller Fa-hien who visited India in the time of the Guptas that the Chandalas or outcaste tribes who dwelt apart like lepers were required when entering a city or bazaar to strike a piece of wood as a warning of their approach so that people may not be polluted by contact with them.³ At some time in the evolution of caste arose that theory of defilement which results in a person of upper caste being defiled by the shadow or the touch of an individual of the low caste. The question of untouchability thereupon begins to assume importance according to the toleration accorded to or extreme view taken of the degree of ceremonial or personal purity.

5. Untouchability in Central India.—I have elsewhere shown in this Report that the Brahmanical hold on the society in these parts is not strong, and that a considerable number of the social groups are immigrants in more recent times. Though Hinduism has exalted ceremonial purity and has laid interdiction against uncleanly habits and persuasions the above-mentioned factors have in practice reduced the problem of impurity to a mild form and untouchability consequently arises in these parts primarily due to certain occupations which are held as unclean by other castes and to unclean habits chiefly in the matter of diet. In its

¹ Quoted in Sherring's *Hindu tribes and castes*.

² *Ibid.*, Art. Chamar.

³ Vincent Smith. *Early history of India*, 207.

operation it is limited to the Chamar who is a tanner, the Basor who is a bamboo worker, the Balai who is a village watchman, and the Bhangi who is a scavenger. It is the profession followed, more than any other consideration that is held in disrespect. Often when I have enquired from the villagers sometimes in remote parts, as to why they would not allow a Balai or a Chamar to come near the temple, or why they are not allowed to draw water from the village well, the invariable answer was their uncleanly profession. In a small village at the foot of the Vindhya, on enquiry I found that the solitary Bhil who had settled in the village had recourse to the village well which was the only supply of water for the inhabitants. When taxed as to why they would not allow the Chamar to draw water while the Bhil enjoyed the privilege, the reply was the Chamar followed an unclean profession and led an unclean life.

6. Other tests besides untouchability.—Untouchability by itself is not a safe test to differentiate the depressed castes from the other castes. The question of touch is largely relative. An orthodox Brahman would bathe even if he were to touch a touchable person. Again untouchability being an irrational feeling with no logical basis, in different localities people have different notions. A Beldar in one locality is considered as untouchable because he keeps donkeys to transport things. A Dhobi is considered to be an untouchable in other places because he washes unclean clothes. The Mochi or the Jingar is not usually considered to be an untouchable and so on. The preliminary lists of depressed classes furnished by the States were so confusing that it was difficult to see light through them. The State people were not to blame because I was trying to see a problem which to them does not exist.

7. Final classification of depressed castes.—So far as it has been possible to ascertain, pollution by touch is quite mild in form though here and there the feeling regarding it may rise to some intensity. Untouchability by itself being no satisfactory test, it had to be coupled with certain social disabilities such as non-access to Hindu places of worship and to the use of village wells from which the higher castes draw water. These social disabilities were found to be strong in their operation. The Chamar or the Balai is never permitted to draw water from the common well. They have separate wells if they could manage to have one. They are also not permitted to enter a place of worship. It was therefore decided to draw a line and include the Chamar, Balai, Basor and Bhangi among the depressed castes as indigenous to the Agency. The Jhamrals of Malwa and the Dharkars of Rewa allied to the Basors were also admitted into the category. The rest Meghwal, Mang, Mahar, Dher, Dom, Domar and Bhambi are not indigenous to the Agency. They are recognised as depressed castes elsewhere and are found in small numbers in this Agency and they are considered as impure locally as well. Thus these thirteen castes have been listed as depressed.

8. Value of the list adopted.—I cannot pretend that this list is in any way complete. A list of the depressed classes for the Agency is at present of no conceivable use unless it be that it is necessary to arrive at the all India total for the depressed class population. The value of a list of this kind depends much upon the particular administrative or social needs of the locality. So long as they have not arisen, it is at present only of an academic interest.

CATALOGUED

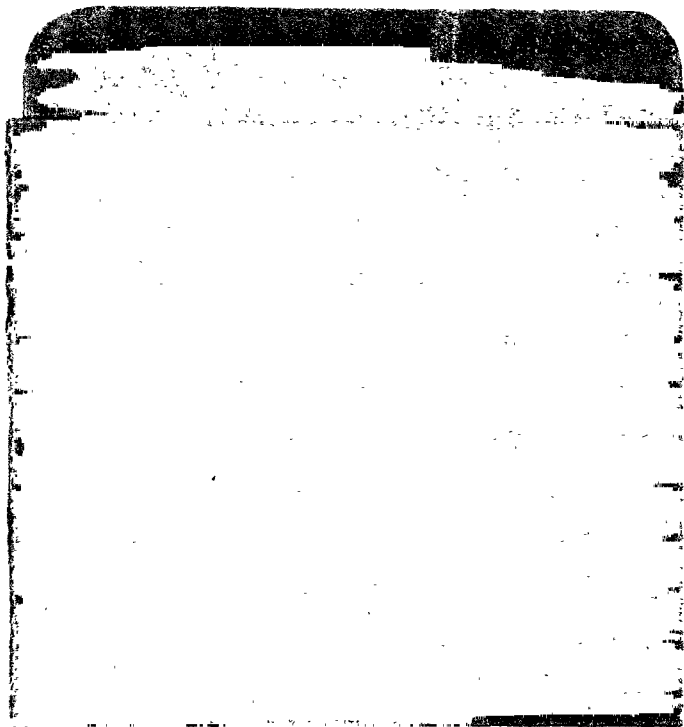

SOC

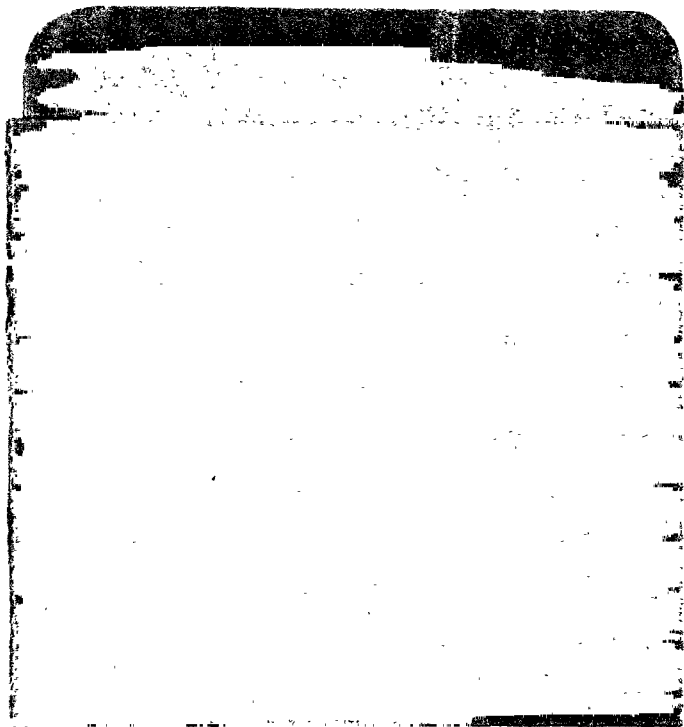

SOC